



JAGUAR XF

C O N T E N T S



EXTERIOR DESIGN
4 - 9



INTERIOR DESIGN
10 - 16



8 SPEED
20 - 21



ENGINES
22-25



CONTROL
28-31

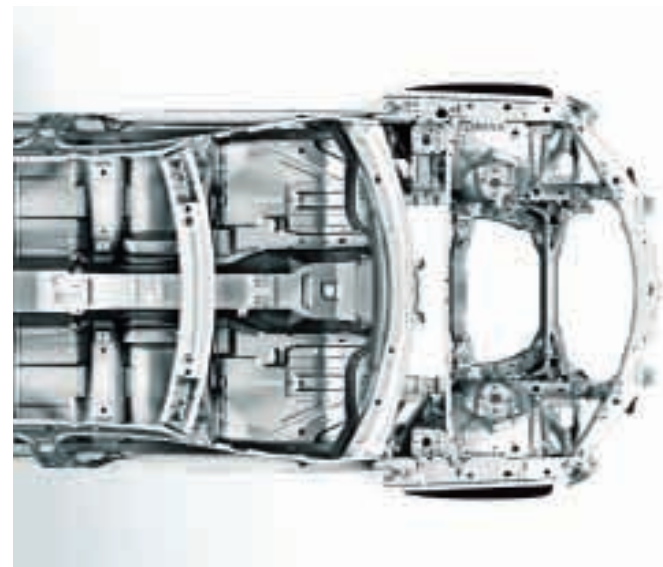

EXPECT THE UNEXPECTED
32-33





THE XF

SPORTS SALOON CAR

Sleek, dynamic, daring, the XF fuses the awe-inspiring power of a sports car with the outstanding comfort of a luxury saloon. It combines Jaguar's renowned flair for style and luxury with a genius for technological innovation.

With the XF, Jaguar delivers tomorrow's car today. Designed and tested in Jaguar's exclusive Virtual Reality design studios using some of the most advanced automotive simulators in the world, model development time for the XF has been dramatically reduced. This enables the XF to incorporate the very latest cutting-edge technology as well as the most contemporary styling and efficient aerodynamic modelling.



EFFICIENT DESIGN

With its bold, bi-function HID Xenon headlamps outlined with crystal white LED daytime running lamps and its muscular bearing, the XF makes a statement of formidable intent. Its flowing lines and primed, nose-down, attitude are more than an athletic pose, they have been precision-honed through exhaustive design testing to perfect the XF's air flow efficiency. Each line in the XF's architecture has been refined to help it produce an unsurpassed aerodynamic performance, reducing fuel consumption and emissions. Beautiful, intense, potent; first the XF captures your imagination and then your heart.



EXPANDING THE RANGE

In a class of its own, the XF is available with three distinct identities. The XF exudes contemporary sporting elegance and refined power. For a more assertive look the XF can be enhanced with Jaguar's Aerodynamic Pack incorporating a unique lower front bumper profile as well as specialised spoiler, rear valance and characteristic side sills. Then, with the XFR, Jaguar delivers the ultimate sports saloon embodied in its more aggressive bearing, sculpted front air intakes, gloss black lower valance and roaring quad exhausts.











CRAFTED INTERIOR

To step into the XF is to take your seat in a theatre of luxury and delight. The exquisitely crafted interior greets you with form hugging supple leathers, classic real wood veneers and crisp contemporary aluminium surfaces. Minimal sweeping lines give the cabin an airy contemporary elegance as every aspect is ergonomically tailored to fit its audience. The XF greets you with an enticing solitary pulsating red 'start' button, ringed in glinting chrome. Engaging the engine instigates the drama - the XF wakes, the performance begins. Even as you lift your finger, the XF's precision rounded aluminium JaguarDrive Selector™ rises snugly into the palm of your hand. The engine growls, almost imperceptibly, as the XF's air vents decisively roll open in unison and cool Phosphor blue lighting ignites to pick out the interior controls. Welcome to the show.







CONNECTIVITY ON THE MOVE

With its array of music, information and up to 17 speakers, the XF cabin is an entire entertainment venue on the move. A Touch-screen in the centre console not only controls climate and navigation data (where navigation is fitted), it also offers a host of audio selections, providing exactly what you want to hear precisely when you want to hear it. Music is stored and instantly served by an optional Virtual Multichanger that plays audio in an uncompressed format from a 30GB hard disk. Uncompressed files result in no loss of high or low-end frequencies which means that they can be recreated as was intended on the original recording. The Portable Audio Interface allows easy connection of devices such as iPod and MP3 players, as well as Bluetooth® audio streaming connectivity with menus conveniently displayed on-screen. The Touch-screen system is designed to complement Jaguar's design philosophy - simple and intuitive. And beyond the buttons, for a hands-free experience, the system can also be completely operated by an optional interactive 'Say What You See' voice control system where the screen simply prompts you so that you are never lost for commands.







BOWERS & WILKINS

In creating an unforgettable driving experience, nothing but the highest fidelity sound system will suffice. The XF offers an option of three different audio systems including the astonishing, precision engineered, Bowers & Wilkins surround sound system. Acoustically designed exclusively for the unique soundscape of the XF's cabin, it delivers 1200W of pure sound through 17 strategically positioned speakers. Combined with the exceptional clarity of the Audyssey MultEQ® audio tuning system, the car provides a truly outstanding soundtrack for every road, for every occasion.

S T O P S T A R T

With the XF, Jaguar introduces the cutting-edge 2.2 AJ i4D Turbo Diesel engine. The precision crafted engine is the first in a Jaguar to incorporate Intelligent Stop/Start technology, lowering fuel consumption by shutting down the engine when the car is in standstill. However as soon as the brake pedal is released the XF's dedicated restart timing enables the engine to be fully operational, ready to go, before the accelerator is even pressed. The 2.2D XF is Jaguar's most fuel efficient vehicle. Even with its improved fuel economy, the XF's Diesel engine makes no compromises in performance. Cooled with a variable-nozzle water system, the 2.2D is able to operate over a great range of temperatures, optimising power at high speed and response torque at low speed.



FOUR CYLINDER 2.2 LITRE DIESEL
COMBINED FUEL CONSUMPTION
5.4 l / 100 km



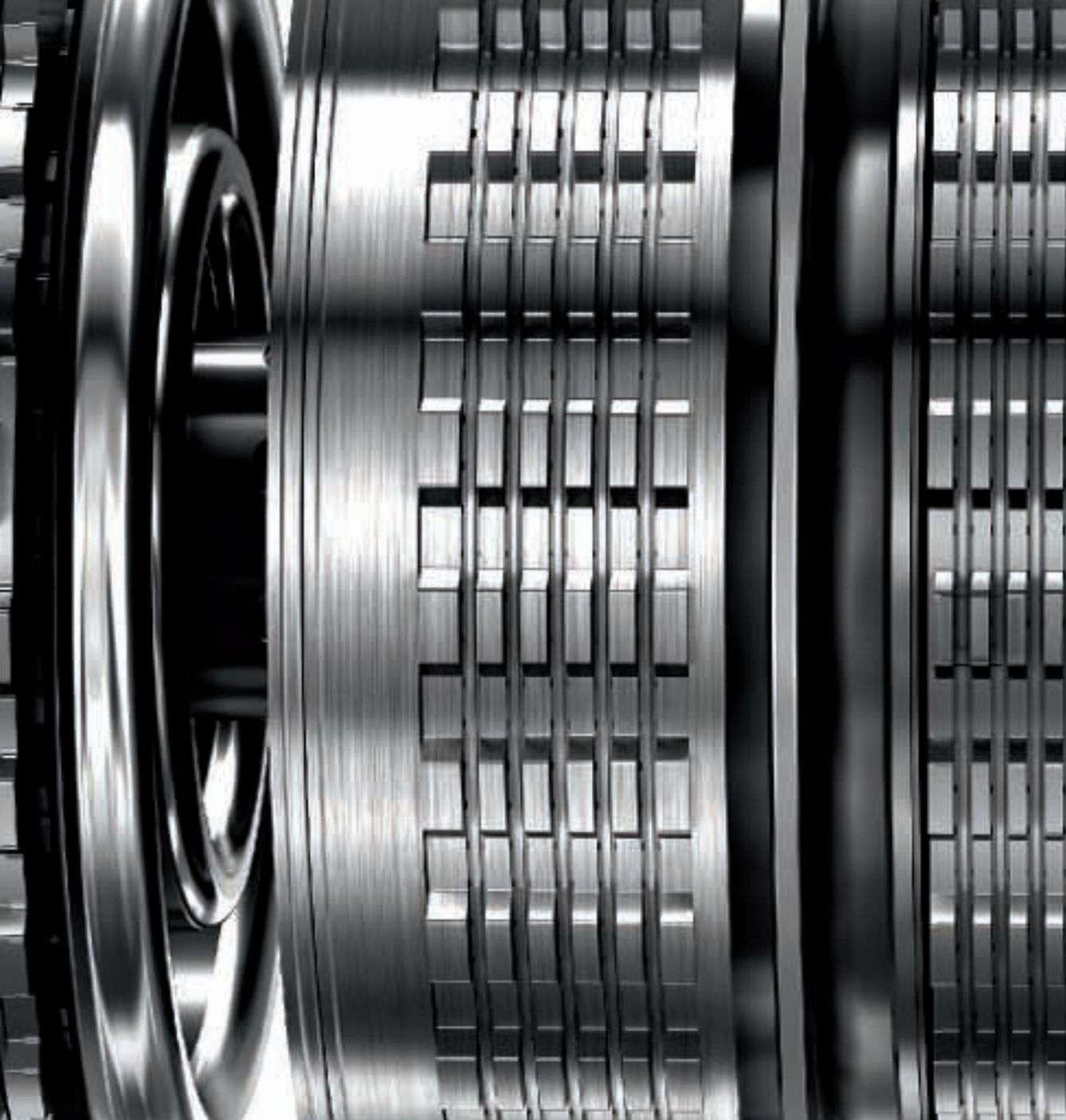

8 SPEED AUTOMATIC TRANSMISSION

Jaguar's commitment to comfort and simplicity is embodied in the XF's outstanding transmission engineering. Its advanced ZF eight-speed automatic transmission delivers barely perceptible, velvet smooth, gear changes. The system continuously calculates the optimum moment to shift gear, reading the road and the driver's operating style, adapting appropriately to constantly optimise performance. Shifts are initiated in just 200 milliseconds - even faster than can be achieved by a professional driver.

What's more, the transmission can 'multi-downshift', for example from 5th to 2nd gear, rather than shifting sequentially as with a conventional system. For a more immediate power experience the driver can override the system with paddle shifts conveniently located behind the steering wheel.

For more extreme conditions special transmission programs can be selected with the JaguarDrive Control™: Sports Mode provides more responsive performance whereas Winter Mode automatically dampens the accelerator pedal response creating more gradual traction on ice. The system also softens the gear shifts to prevent sudden speed changes, increasing control when tyre grip is low in slippery conditions.

DIESEL

ENGINE CHOICE

The XF comes with a choice of Diesel engines to satisfy a range of priorities. These include the 2.2 Litre engine producing the lowest CO₂ emissions in the XF range without compromise to performance, the 3.0 Litre which delivers formidable torque and power or the 3.0 Litre S which is tuned to maximise performance.

EFFICIENCY

2.2 LITRE

i 4 ENGINE

2.2 LITRE 4 CYLINDER DIESEL i4
POWER: 140kW @ 3,500rpm
ACCELERATION: 0-100km/h in 8.5 seconds
MAX SPEED: 225km/h
COMBINED FUEL CONSUMPTION: 5.4 l/100km
CO₂ EMISSIONS: 149g/km



TORQUE

3.0 LITRE

V 6 D I E S E L

3.0 LITRE V6 DIESEL
POWER: 177kW @ 4,000rpm
ACCELERATION: 0-100km/h in 7.1 seconds
MAX SPEED: 240km/h
COMBINED FUEL CONSUMPTION: 6.3 l/100km
CO₂ EMISSIONS: 169g/km

PERFORMANCE

3.0 LITRE

V 6 D I E S E L S

3.0 LITRE V6 DIESEL S
POWER: 202kW @ 4,000rpm
ACCELERATION: 0-100km/h in 6.4 seconds
MAX SPEED: 250km/h electronically limited
COMBINED FUEL CONSUMPTION: 6.3 l/100km
CO₂ EMISSIONS: 169g/km

PETROL ENGINE CHOICE

The XF comes with a choice of three Petrol engines to satisfy a range of priorities. These include the 3.0 Litre V6, the 5.0 Litre V8 and the 5.0 Litre V8 Supercharged.

ECONOMY

3.0 LITRE

3.0 V6 PETROL

POWER: 175kW @ 6,800rpm

ACCELERATION: 0-100km/h in 8.3 seconds

MAX SPEED: 237km/h

COMBINED FUEL CONSUMPTION: 10.5 l/100km

CO₂ EMISSIONS: 249g/km



PERFORMANCE

V8 5.0 LITRE

5.0 LITRE V8 PETROL
POWER: 283kW @ 6,500rpm
ACCELERATION: 0-100km/h in 5.7 seconds
MAX SPEED: 250km/h electronically limited
COMBINED FUEL CONSUMPTION: 11.1 l/100km
CO₂ EMISSIONS: 264g/km

SUPERCHARGED

V8 5.0 LITRE

5.0 LITRE V8 PETROL SUPERCHARGED
POWER: 375kW @ 6,000 - 6,500rpm
ACCELERATION: 0-100km/h in 4.9 seconds
MAX SPEED: 250km/h electronically limited
COMBINED FUEL CONSUMPTION: 12.5 l/100km
CO₂ EMISSIONS: 292g/km



PURE PERFORMANCE

For the ultimate in performance, the XFR takes the XF to another dimension. With a blistering acceleration of 0-100km/h in 4.9 seconds the XFR intensifies the sporting experience without compromising any of the comfort. Beneath the expanded bonnet is Jaguar's acclaimed 5.0 AJ-V8 GEN III Supercharged engine. This all-aluminium quad-cam powerplant delivers exhilarating performance. Its incredible 625Nm torque is provided by Jaguar's ground-breaking Cam Profile Switching system constantly optimising volumetric efficiency whatever the load or speed. The XFR delivers the sublime luxury of a saloon with the muscle of a thoroughbred champion.





CONFIDENCE

To fully experience the XF's powerful performance, the driver is constantly assisted by the expertise of the car itself. The XF's revolutionary optional Adaptive Dynamics System continuously monitors the suspension, varying the damping to suit the conditions, whether cornering, navigating potholes or accelerating on the motorway. The system calculates the appropriate suspension response 500 times every second. Adjusting the dampers to help keep the car as flat, stable and secure as possible allows confident handling without any loss of ride comfort. On the XFR agility is further enhanced by an Active Differential which analyses the firmness of the road surface adjusting the differential of each wheel to constantly optimise traction, helping the vehicle to stick to the road on the tightest of bends during performance driving.

To increase driver satisfaction and feedback from the car, the XF's Servotronic steering adjusts the level of power assistance to the steering according to road speed. The result is reduced assistance and firmer steering as speed increases and more assistance at low speeds for easy manoeuvring.

With a body architecture designed to be one of the most rigid in its class, the XF provides outstanding road feedback. Its adaptive systems support the driver as the XF reaches more extreme situations, they assist but never overwhelm.







ACTIVE SAFETY

The XF's safety systems are anticipatory, utilising an array of technological features to be ready for almost anything and assist the driver in dealing with the unexpected. Bi-function HID Xenon headlamps provide a powerful pure light. They are available with Adaptive Front Lighting which reacts to the car's speed and driver input to deflect headlamp beams deep into corners during turns for extra confidence at night. Also available is intelligent high beam. This system automatically detects preceding or oncoming traffic or street lights to switch to low beam and then switches back to high beam when appropriate.

The XF features optional Adaptive Cruise Control which monitors vehicles around it, automatically slowing if the vehicle in front brakes then resuming the pre-set speed once the obstruction is cleared. During parking, an optional visual display and variable audio warning illustrate the proximity of other vehicles.

The Advanced Braking Systems help assure smooth stopping in wide ranging conditions and include an Intelligent Emergency Brake option with Adaptive Cruise Control which detects the severity of the stopping situation and applies optimum crisis braking forces as necessary.



8 AIRBAGS

INCLUDING DRIVER AND FRONT PASSENGER THORAX PROTECTION,
SIDE CURTAINS FRONT AND REAR

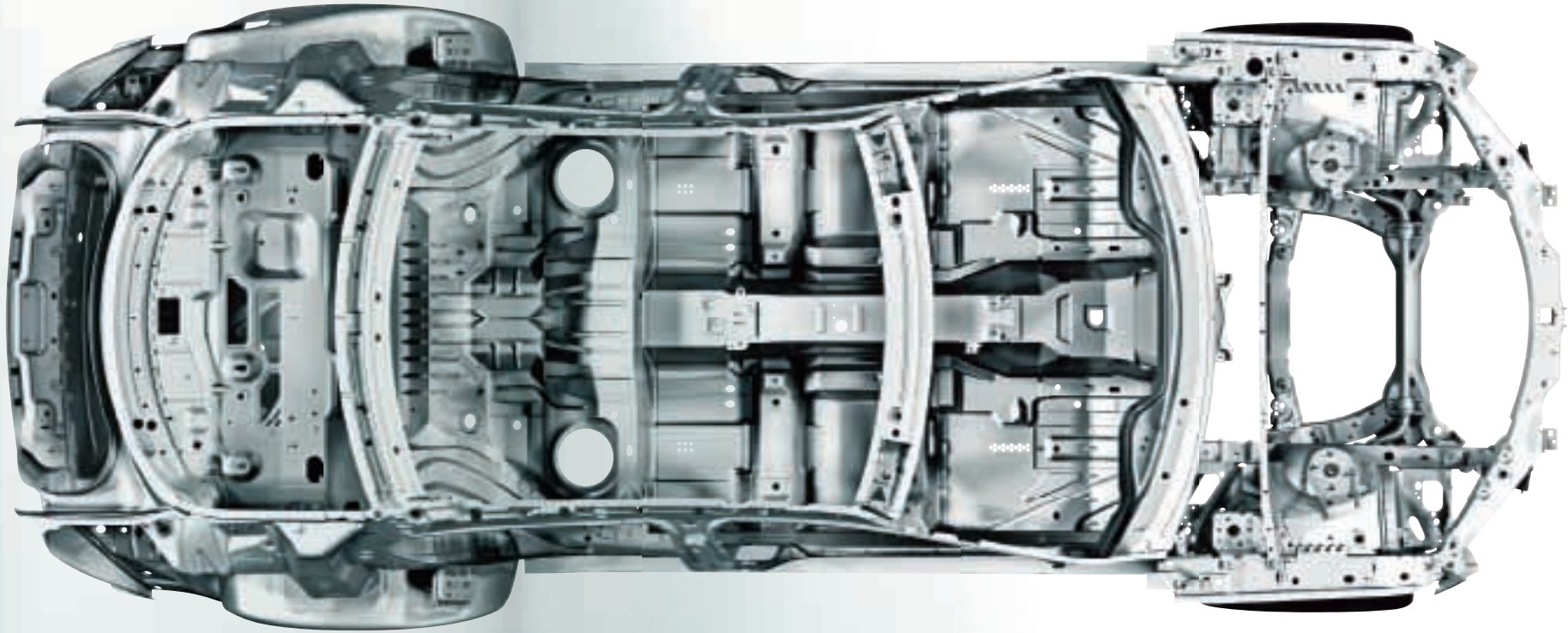

UNDERLYING CONFIDENCE

Beneath the XF's aerodynamic lines is a tensile body, enveloping driver and passenger alike. Jaguar has used the latest material technologies to forge the XF superstructure from lighter, stronger, more durable new generation metals including boron with high carbon, hot-formed, and bake-hardened steels.

The XF also helps protect those around the car. Should an impact with a pedestrian be unfortunate enough to occur, the XF's Pedestrian Contact Sensing System™ instantaneously raises the bonnet by a short distance to cushion the casualty's body and to avoid contact with hard surfaces below the bonnet.

STRUCTURE

SAFETY CELL DESIGN

FOR STRENGTH.

PEDESTRIAN CONTACT

SENSING SYSTEM™.

SUSTAINABILITY

At Jaguar, we take our responsibility to the environment very seriously indeed. We are committed to a reduction in our dependency on fossil fuels and the production of man-made CO₂ as well as using fewer natural resources and creating less waste. Our focus is both on the whole lifecycle environmental impact of the vehicles we manufacture and on our wider business process.

We are continuously striving to reinforce our sustainability strategy while still delivering the performance expected from every Jaguar car. The XF delivers improved performance from downsized engines. The latest XF 2.2 Litre Diesel with Intelligent Stop/Start, for example, is the most efficient Jaguar ever. It is also in the forefront of the use of lightweight components and technologies.

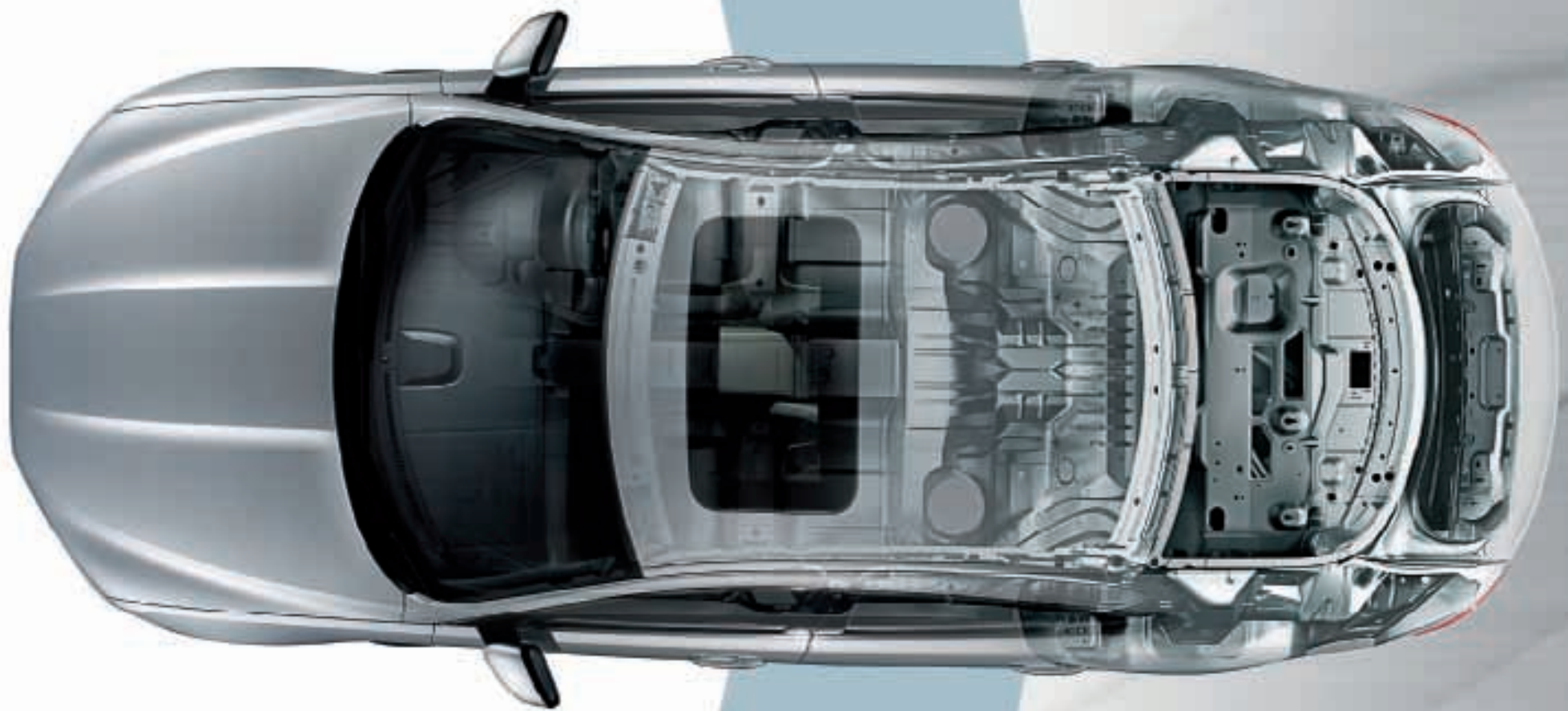

JAGUAR

XF LUXURY 38 XFS 42 XF PREMIUM LUXURY 46 XF PORTFOLIO 50
XFR 54 AERODYNAMIC 58 SPORT INTERIOR 60 ACCESSORIES 76





X F R A N G E

A D R I V I N G F O R C E I N D E S I G N

A driving force in design, engineering and innovation, the XF harnesses the breathtaking power of a sports car to the sublime pleasure of a world class luxury saloon. Whatever choice of model or options each individual customer makes, every XF epitomises Jaguar's pursuit of excellence and attention to detail. The following section provides in-depth descriptions and specifications of the entire XF range, with each model's main features and available options. It also gives a complete selection of exciting exterior finishes and premium interior trims, which offer further opportunities to make an XF even more individual and more personal.

XF LUXURY



PERFORMANCE

2.2 DIESEL

POWER – 140kW

0-100 km/h SECONDS – 8.5

CARBON DIOXIDE EMISSIONS g/km – 149

URBAN l/100 km – 6.6

EXTRA URBAN l/100 km – 4.8

COMBINED l/100 km – 5.4

3.0 V6 DIESEL

POWER – 177kW

0-100 km/h SECONDS – 7.1

CARBON DIOXIDE EMISSIONS g/km – 169

URBAN l/100 km – 8.7

EXTRA URBAN l/100 km – 5.0

COMBINED l/100 km – 6.3

3.0 V6 PETROL

POWER – 175kW

0-100 km/h SECONDS – 8.3

CARBON DIOXIDE EMISSIONS g/km – 249

URBAN l/100 km – 15.8

EXTRA URBAN l/100 km – 7.5

COMBINED l/100 km – 10.5

5.0 V8 PETROL

POWER – 283kW

0-100 km/h SECONDS – 5.7

CARBON DIOXIDE EMISSIONS g/km – 264

URBAN l/100 km – 17.3

EXTRA URBAN l/100 km – 7.8

COMBINED l/100 km – 11.1

MAIN FEATURES FOR

2.2 DIESEL AND 3.0 PETROL

6-speed electronic automatic transmission with Jaguar Sequential Shift™ (Available on petrol engines only)

8-speed electronic automatic transmission with Jaguar Sequential Shift™ (Available on diesel engines only)

Suede cloth seats with Bond grain leather seat facings

Intelligent Stop/Start System (Available on 2.2 Diesel only)

17" Libra alloy wheels

Electric driver/passenger 4/4 way seat adjustment

Jaguar Smart Key System™ with Keyless start

Rear parking aid with Touch-screen visual indicator

Bond grain stitched and tailored instrument panel

Front Media Interface with USB and iPod connectivity

Jaguar 400W sound system

Bluetooth® telephone connectivity with audio streaming

MAIN FEATURES FOR

FOR 3.0 DIESEL AND 5.0 PETROL

6-speed electronic automatic transmission with Jaguar Sequential Shift™ (Available on petrol engines only)

8-speed electronic automatic transmission with Jaguar Sequential Shift™ (Available on diesel engines only)

17" Ursa alloy wheels standard on 3.0 Diesel

20" Hydra alloy wheels standard on 5.0 Petrol

Bond grain leather seat facings

Electric driver/passenger 6/6 way seat adjustment

Navigation system with HDD mapping, DVD player, destination entry and voice guidance

Jaguar Smart Key System™ with Keyless start and Keyless entry

Rear parking aid with Touch-screen visual indicator

Bond grain stitched and tailored instrument panel

Front Media Interface with USB and iPod connectivity

Jaguar 400W sound system

Bluetooth® telephone connectivity with audio streaming

WHEELS

Standard



17" Libra
(Standard on 2.2 Diesel
and 3.0 Petrol)



17" Ursa
(Standard on 3.0 Diesel)



17" Ursa
(Optional on 2.2 Diesel
and 3.0 Petrol)



18" Vela



18" Lyra



19" Caravela



19" Artura



19" Aquila



20" Hydra
(Standard on 5.0 Petrol)



20" Draco Silver Finish



20" Draco Dark Grey Finish
(Diamond turned rim)



20" Gloss Black Kalimnos

Image shown with Vela wheels, which are optional on 2.2D, 3.0D and 3.0 V6 Petrol



LUXURY

INTERIOR CHOICE

VENEERS

Standard

Options

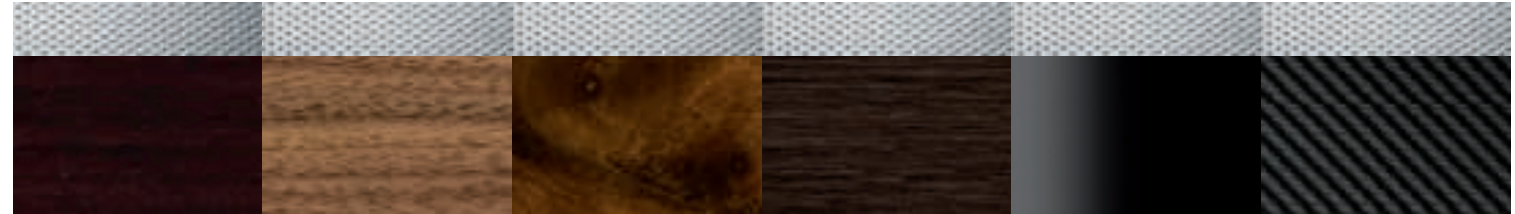

Knurled Aluminium with Satin Rosewood
(Standard on 3.0 Diesel and 5.0 Petrol)

Knurled Aluminium with Satin American Walnut
(Standard on 2.2 Diesel and 3.0 Petrol)

Knurled Aluminium with Burr Walnut

Knurled Aluminium with Rich Oak

Knurled Aluminium with Piano Black

Knurled Aluminium with Carbon Fibre
(Available only on 3.0 Diesel and 5.0 Petrol)

INTERIOR ENVIRONMENT

Standard

HEADLININGS

UPPER FACIA

SEAT TRIM



Warm Charcoal Bond grain leather seat facings with Warm Charcoal upper facia and Dove headlining*
(Available only on 3.0 Diesel and 5.0 Petrol)

Dove Bond grain leather seat facings with Warm Charcoal upper facia and Dove headlining*
(Available only on 3.0 Diesel and 5.0 Petrol)

Barley Bond grain leather seat facings with Warm Charcoal upper facia and Canvas headlining*
(Available only on 3.0 Diesel and 5.0 Petrol)

Warm Charcoal Suede cloth seats with Bond grain leather facings with Warm Charcoal Bond grain upper facia and Dove headlining*
(Available only on 2.2 Diesel and 3.0 Petrol)

Barley Suede cloth seats with Bond grain leather facings with Warm Charcoal Bond grain upper facia and Canvas headlining*
(Available only on 2.2 Diesel and 3.0 Petrol)

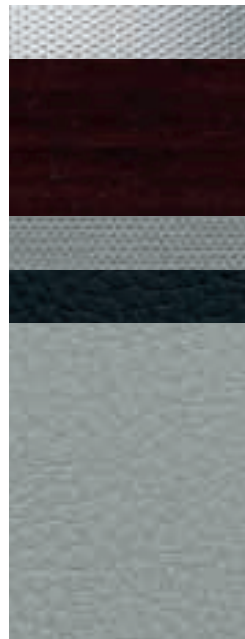

INTERIOR SHOWN
Dove Bond grain leather seat facings with Warm Charcoal upper facia and Dove headlining with Satin Rosewood veneer

*Optional Jet Morzine headlining available

XF^s



PERFORMANCE

3.0 V6 DIESEL S

POWER – 202kW

0-100 km/h SECONDS – 6.4

CARBON DIOXIDE EMISSIONS g/km – 169

URBAN l/100 km – 8.7

EXTRA URBAN l/100 km – 5.0

COMBINED l/100 km – 6.3

MAIN FEATURES

8-speed electronic automatic transmission with Jaguar Sequential Shift™

JaguarDrive Control™ with Dynamic Mode

19" Aquila alloy wheels

Bond grain leather seat facings with contrast stitch

Electric driver/passenger 6/6 way seat adjustment

Navigation system with HDD mapping, DVD player, postcode entry, destination entry and voice guidance

Jaguar Smart Key System™ with Keyless start and Keyless entry

Rear parking aid with Touch-screen visual indicator

Bond grain stitched and tailored instrument panel

Front Media Interface with USB and iPod connectivity

Jaguar 400W sound system

Bluetooth® telephone connectivity with audio streaming

Aerodynamic Pack

Adaptive Dynamics

WHEELS

Standard



19" Aquila

Options



20" Hydra



20" Draco Dark Grey Finish
(Diamond turned rim)



20" Gloss Black Kalimnos



XFS

INTERIOR CHOICE

VENEERS

Standard

Options



Knurled Aluminium with Satin Rosewood

Knurled Aluminium with Satin American Walnut

Knurled Aluminium with Piano Black

Knurled Aluminium with Burr Walnut

Knurled Aluminium with Carbon Fibre

INTERIOR ENVIRONMENT

Standard

Options

HEADLININGS

UPPER FACIA

SEAT TRIM



Warm Charcoal Bond grain leather seat facings with Warm Charcoal upper facia and Dove headlining*

Dove Bond grain leather seat facings with Warm Charcoal upper facia and Dove headlining*

Barley Bond grain leather seat facings with Warm Charcoal upper facia and Canvas headlining*

INTERIOR SHOWN
Warm Charcoal Bond grain leather seats with Warm Charcoal upper facia and Dove headlining with Piano Black and Knurled Aluminium veneer

*Optional Dove Suedecloth, Jet Morzine and Jet Suedecloth headlinings available

X F PREMIUM LUXURY



PERFORMANCE

3.2 DIESEL

POWER – 140kW

0-100 km/h SECONDS – 8.5

CARBON DIOXIDE EMISSIONS g/km – 149

URBAN l/100 km – 6.6

EXTRA URBAN l/100 km – 4.8

COMBINED l/100 km – 5.4

3.0 V6 DIESEL

POWER – 177kW

0-100 km/h SECONDS – 7.1

CARBON DIOXIDE EMISSIONS g/km – 169

URBAN l/100 km – 8.7

EXTRA URBAN l/100 km – 5.0

COMBINED l/100 km – 6.3

3.0 V6 PETROL

POWER – 175kW

0-100 km/h SECONDS – 8.3

CARBON DIOXIDE EMISSIONS g/km – 249

URBAN l/100 km – 15.8

EXTRA URBAN l/100 km – 7.5

COMBINED l/100 km – 10.5

Image shown with optional Vela wheels

MAIN FEATURES

FOR 2.2 DIESEL AND 3.0 PETROL

6-speed electronic automatic transmission with Jaguar Sequential Shift™ (Available on petrol engines only)

8-speed electronic automatic transmission with Jaguar Sequential Shift™ (Available on diesel engines only)

Bond grain leather seats

Intelligent Stop/Start System (Available on 2.2 Diesel only)

17" Ursa alloy wheels

Electric driver/passenger (6/6 way) seat adjustment with driver memory function

Jaguar Smart Key System™ with Keyless start and Keyless entry

Navigation system with HDD mapping, DVD player, destination entry and voice guidance

Rear parking aid with Touch-screen visual indicator

Bond grain stitched and tailored instrument panel

Front Media Interface with USB and iPod connectivity

Jaguar 400W sound system

Bluetooth® telephone connectivity with audio streaming

Exterior mirrors - auto dimming, powerfolding with approach lights

Auto dimming rear view mirror

MAIN FEATURES

FOR 3.0 DIESEL

8-speed electronic automatic transmission with Jaguar Sequential Shift™ (Available on diesel engines only)

Soft grain leather seats

18" Vela alloy wheels

Electric driver/passenger (10/6 way) seat adjustment with driver memory function

Jaguar Smart Key System™ with Keyless start and Keyless entry,

Navigation system with HDD mapping, DVD player, destination entry and voice guidance

Front and rear parking aid with Touch-screen visual indicator and reverse park camera with guidance

Soft grain stitched and tailored instrument panel

Front Media Interface with USB and iPod connectivity

Jaguar 600W premium sound system with 11 speakers including 1 subwoofer

Bluetooth® telephone connectivity with audio streaming

Exterior mirrors - auto dimming, powerfolding with approach lights

Auto dimming rear view mirror

Front and rear carpet mat set

WHEELS

Standard



17" Ursa
(Standard on 2.2 Diesel and 3.0 Petrol)

Options



18" Vela
(Standard on 3.0 Diesel)



18" Lyra



19" Caravela



19" Artura



19" Aquila



20" Hydra



20" Draco Silver Finish



20" Draco Dark Grey Finish
(Diamond turned rim)



20" Gloss Black Kalimnos



PREMIUM LUXURY

INTERIOR CHOICE

VENEERS

Standard

Options

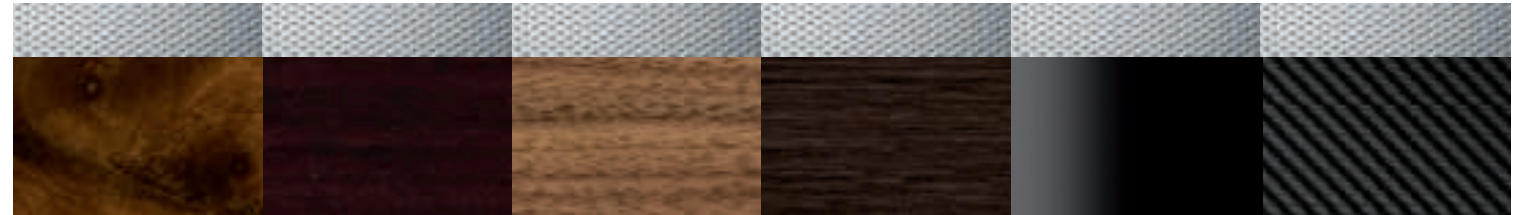

Knurled Aluminium with Burr Walnut
(Standard on 3.0 Diesel)

Knurled Aluminium with Satin Rosewood
(Standard on 2.2 Diesel and 3.0 Petrol. Optional on 3.0 Diesel).

Knurled Aluminium with Satin American Walnut

Knurled Aluminium with Rich Oak

Knurled Aluminium with Piano Black

Knurled Aluminium with Carbon Fibre

INTERIOR ENVIRONMENT

Standard

Options

HEADLININGS

UPPER FACIA

SEAT TRIM



Warm Charcoal soft grain leather seats with Warm Charcoal soft grain upper facia and Dove headlining*
(Available only on 3.0 Diesel)

Dove soft grain leather seats with Warm Charcoal soft grain upper facia and Dove headlining*
(Available only on 3.0 Diesel)

Barley soft grain leather seats with Truffle soft grain upper facia and Canvas headlining.
(Available only on 3.0 Diesel)

Ivory soft grain leather seats with Oyster soft grain upper facia and Canvas headlining.
(Available only on 3.0 Diesel)

Warm Charcoal Bond grain leather seat facings with Warm Charcoal upper facia and Dove headlining*
(Standard on 2.2 Diesel and 3.0 Petrol)

Dove Bond grain leather seat facings with Warm Charcoal upper facia and Dove headlining*
(Available only on 2.2 Diesel and 3.0 Petrol)

Barley Bond grain leather seat facings with Warm Charcoal upper facia and Canvas headlining*
(Available only on 2.2 Diesel and 3.0 Petrol)

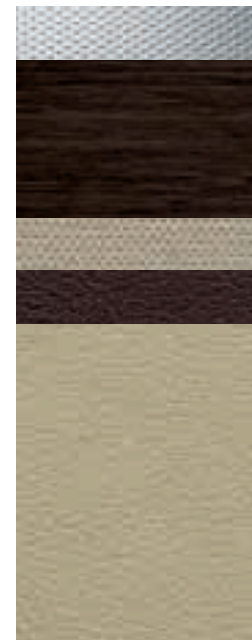

INTERIOR SHOWN
Barley soft grain leather seats with Truffle soft grain upper facia and Canvas headlining with Rich Oak veneer

*Optional Jet Morzine headlinings available

X F PORTFOLIO



PERFORMANCE

3.0 V6 DIESEL S

POWER – 202kW

0-100 km/h SECONDS – 6.4

CARBON DIOXIDE EMISSIONS g/km – 169

URBAN l/100 km – 8.7

EXTRA URBAN l/100 km – 5.0

COMBINED l/100 km – 6.3

5.0 V8 PETROL

POWER – 283kW

0-100 km/h SECONDS – 5.7

CARBON DIOXIDE EMISSIONS g/km – 264

URBAN l/100 km – 17.3

EXTRA URBAN l/100 km – 7.8

COMBINED l/100 km – 11.1

MAIN FEATURES

6-speed electronic automatic transmission with Jaguar Sequential Shift™ (Available on petrol engines only)

8-speed electronic automatic transmission with Jaguar Sequential Shift™ (Available on diesel engines only)

19" Caravela alloy wheels

Soft grain leather seats

Electric driver/passenger (16/12 way) seat adjustment with driver memory function and contrast hoop

Active, ventilated front seats - heated/cooled

Navigation system with HDD mapping, DVD player, destination entry and voice guidance

Jaguar Smart Key System™ with Keyless start and Keyless entry

Front and rear parking aid with rear camera

Soft grain leather stitched and tailored instrument panel with contrast stitch

Front Media Interface with USB and iPod connectivity

Jaguar 600W premium sound system with 11 speakers including 1 subwoofer

Bluetooth® telephone connectivity with audio streaming

Exterior mirrors - auto dimming, powerfolding with approach lights

Auto dimming interior view mirror

Premium paint

Jaguar Suedecloth headlining

Premium front and rear carpet mat set

SELECTED OPTIONS

Heated windscreen with timer

Bowers & Wilkins 1200W premium sound system with 17 speakers

Adaptive Cruise Control (ACC) with Intelligent Emergency Brake (IEB) and Active Seat Belts

60/40 split folding rear seats

Interactive Voice

WHEELS

Standard



19" Caravela

Options



19" Artura



19" Aquila



20" Hydra



20" Draco Silver Finish



20" Draco Dark Grey Finish
(Diamond turned rim)



20" Gloss Black Kalimnos



PORTFOLIO

INTERIOR CHOICE

VENEERS

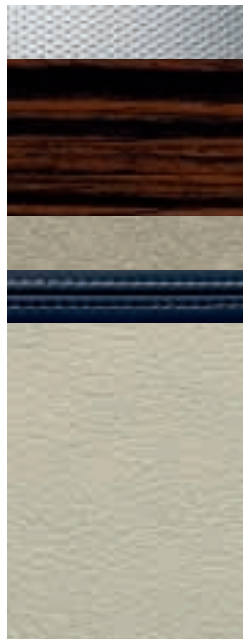
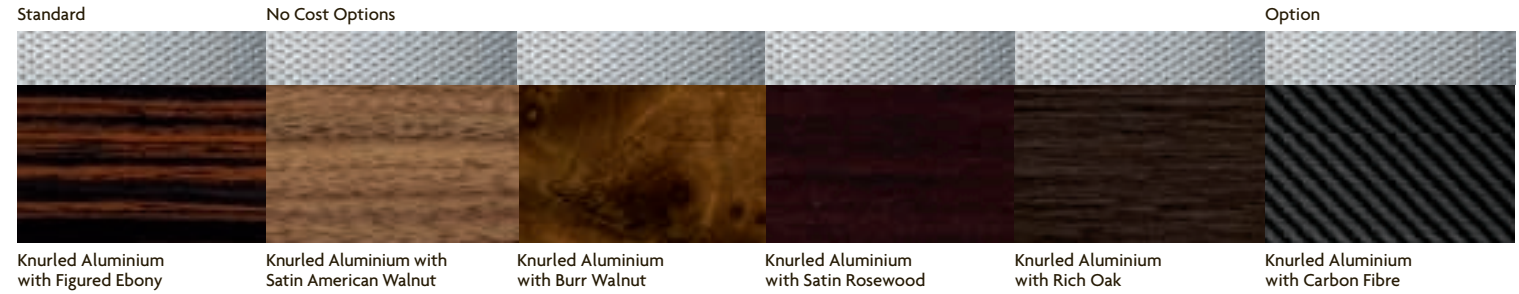

INTERIOR SHOWN
Ivory soft grain leather seats, with Navy and Ivory contrast stitch leather upper facia and Canvas headlining with Figured Ebony veneer

INTERIOR ENVIRONMENT



*Optional Jet Suedecloth headlinings available

XFR



PERFORMANCE

5.0 V8 SUPERCHARGED PETROL

POWER – 375kW

0-100 km/h SECONDS – 4.9

CARBON DIOXIDE EMISSIONS g/km – 292

URBAN l/100 km – 18.7

EXTRA URBAN l/100 km – 8.7

COMBINED l/100 km – 12.5

MAIN FEATURES

Adaptive Dynamics

Active Differential

JaguarDrive Control™ with Dynamic mode

Jaguar R Styling

- Unique front bumper with larger air intakes
- Front grille with black mesh inserts
- Heat extracting bonnet louvres
- Rear spoiler
- Quad exhaust tailpipes
- Unique rear R valance

Soft grain leather R sports seats

Electric driver/passenger (18/18 way) seat adjustment with driver memory function

Active, ventilated front seats - heated/cooled

Navigation system with HDD mapping, DVD player, destination entry and voice guidance

Jaguar Smart Key System™ with Keyless start and Keyless entry

Front and rear parking aid with Touch-screen visual indicator

Reverse park camera with guidance

Soft grain leather stitched and tailored instrument panel with contrast stitch

Front Media Interface with USB and iPod connectivity

Bowers & Wilkins 1200W premium sound system with 17 speakers including 1 subwoofer

Bluetooth® telephone connectivity with audio streaming

SELECTED OPTIONS

Heated windscreen with timer

Digital/Analogue TV

Interactive Voice

WHEELS

Standard



20" Nevis

Options



20" Draco Dark Grey Finish
(Diamond turned rim)



20" Draco Silver Finish



IR



R

XFR

INTERIOR CHOICE

VENEERS



INTERIOR ENVIRONMENT



INTERIOR SHOWN
 Warm Charcoal soft grain leather seats with Ivory contrast seat stitch, Warm Charcoal leather upper facia and Dove headlining with optional Carbon Fibre veneer

Warm Charcoal soft grain leather seats with Warm Charcoal leather upper facia and Dove or optional Jet Suedecloth premium headlining

Warm Charcoal soft grain leather seats with Ivory contrast seat stitch, Warm Charcoal with Ivory contrast stitch leather upper facia with Dove or optional Jet Suedecloth premium headlining

Ivory soft grain leather seats with Warm Charcoal and Ivory contrast seat stitch leather upper facia and Canvas or optional Jet Suedecloth premium headlining

London Tan and Warm Charcoal soft grain leather seats with London Tan contrast seat stitch, Warm Charcoal and London Tan contrast stitch leather upper facia with Canvas or optional Jet Suedecloth premium headlining

Red Zone and Warm Charcoal soft grain leather seats with Red Zone contrast seat stitch, Warm Charcoal and Red Zone contrast stitch leather upper facia with Dove or optional Jet Suedecloth premium headlining

A E R O D Y N A M I C

XF AERODYNAMIC PACK. Custom designed to integrate seamlessly with the XF's body, this pack provides a number of enhancements to the vehicle's rear, front and sides including boot spoiler and modified front bumper, providing a distinctive new profile.



This pack includes:

- Restyled front bumper with sculpted lower air intake blades
- Black front grille (where not already fitted)
- Side sill extensions
- Rear boot lid spoiler
- Restyled rear valance (Only available on 3.0 V6 Diesel, 3.0 V6 Diesel S and 5.0 V8 Petrol)



This pack is only optional across the following engine models; 2.2 Diesel, 3.0 V6 Diesel, 3.0 V6 Diesel S and 5.0 V8 Petrol
This pack is not available in Kyanite Blue and Italian Racing Red paint options



SPORT INTERIOR

XF INTERIOR PACK. Enrich the XF's interior by accentuating its comfort, luxury and sporting credentials. Soft grain or Bond grain leather seats feature effortless electric adjustment and driver memory plus the crafted Piano Black veneer is fitted as standard.

Bond grain sport interior includes:

- Bond grain seats with leather seat facings
- Sports seats with electric driver/passenger adjustment (18/18 way) and driver memory function. Includes two memory settings for driver's seat, exterior mirrors and steering column
- Heated front seats
- Piano Black veneer as standard

Soft grain sport interior includes:

- Soft grain leather seats
- Sports seats with electric driver/passenger adjustment (18/18 way) and driver memory function. Includes two memory settings for driver's seat, exterior mirrors and steering column
- Active, ventilated front seats - heated/cooled
- Optional contrast stitch on upper facia
- Piano Black veneer as standard

Interior shown on left: Optional Ivory soft grain seats with Warm Charcoal and Ivory contrast stitch upper facia with Canvas headlining and standard Piano Black veneer.



BOND GRAIN

INTERIOR CHOICE

VENEERS

Standard

Options

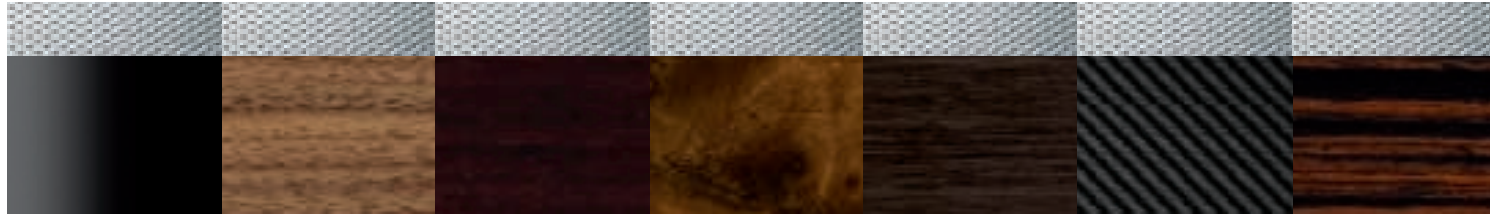

Knurled Aluminium with Piano Black

Knurled Aluminium with Satin American Walnut

Knurled Aluminium with Satin Rosewood

Knurled Aluminium with Burr Walnut

Knurled Aluminium with Rich Oak

Knurled Aluminium with Carbon Fibre

Knurled Aluminium with Figured Ebony

INTERIOR ENVIRONMENT

Standard



Warm Charcoal Bond grain leather seats with Warm Charcoal upper facia and Dove headlining*

Dove Bond grain leather seats with Warm Charcoal upper facia and Dove headlining*

Barley Bond grain leather seats with Warm Charcoal upper facia and Canvas headlining†

*Optional Dove Suedecloth, Jet Morzine and Jet Suedecloth headlinings available
†Optional Canvas Suedecloth, Jet Morzine and Jet Suedecloth headlinings available

SOFT GRAIN

INTERIOR CHOICE

VENEERS

Standard

Options

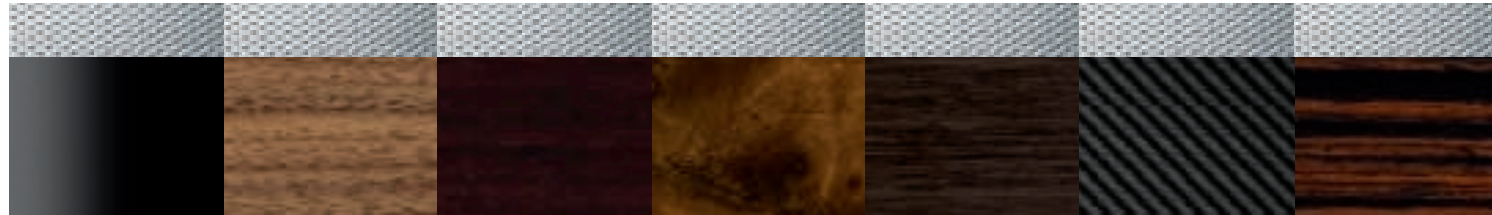

Knurled Aluminium with Piano Black

Knurled Aluminium with Satin American Walnut

Knurled Aluminium with Satin Rosewood

Knurled Aluminium with Burr Walnut

Knurled Aluminium with Rich Oak

Knurled Aluminium with Carbon Fibre

Knurled Aluminium with Figured Ebony

INTERIOR ENVIRONMENT

Standard

Options

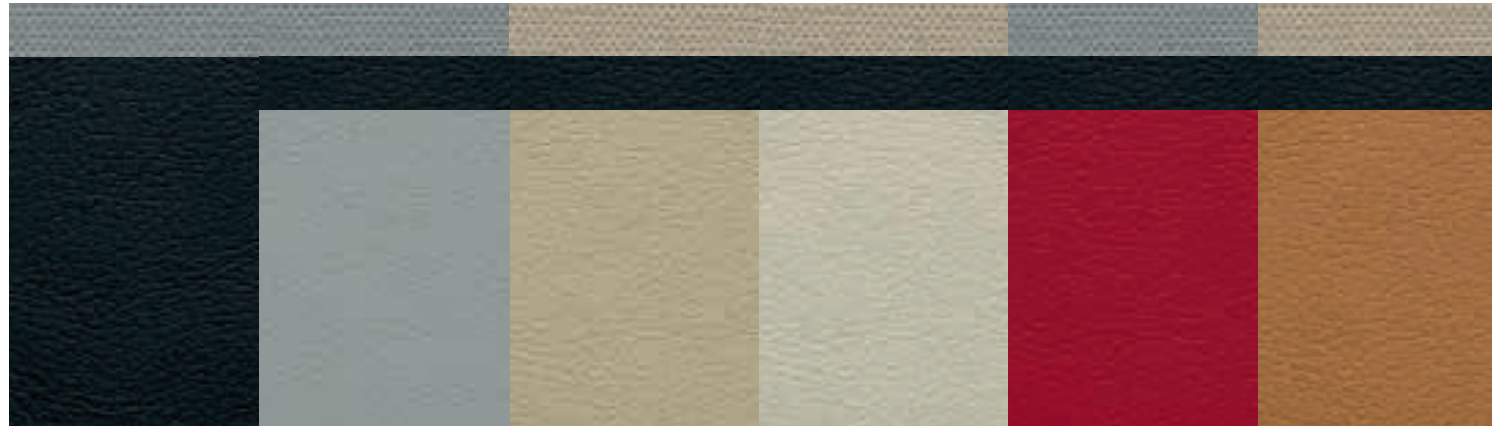

Warm Charcoal soft grain leather seats with Warm Charcoal upper facia and Dove headlining*

Dove soft grain leather seats with Warm Charcoal upper facia and Dove headlining*

Barley soft grain leather seats with Warm Charcoal upper facia and Canvas headlining†

Ivory soft grain leather seats with Warm Charcoal upper facia and Canvas headlining†

Red Zone soft grain leather seats with Warm Charcoal upper facia and Dove headlining*

London Tan soft grain leather seats with Warm Charcoal upper facia and Canvas headlining†

*Optional Dove Suedecloth, Jet Morzine and Jet Suedecloth headlinings available

†Optional Canvas Suedecloth, Jet Morzine and Jet Suedecloth headlinings available

BLACK PACK

XF BLACK PACK. Uniquely designed to complement the alluring new body style of the XF, this pack provides distinctive enhancements of a high gloss, black finish to the vehicle's front and rear to include window surrounds, front grille and rear signature blades.



This pack includes:

- Gloss Black window surround
- Gloss Black front grille with gloss black surround
- Gloss Black front bumper (includes blade on 3.0 Diesel S and 5.0 V8 and whole surround on the XFR)
- Body coloured rear Signature blade



This pack is available only in the following colour choices; Ultimate Black, Polaris White, Rhodium Silver, Stratus Grey and Lunar Grey.



EXTERIOR COLOURS

STANDARD

Ebony

Polaris White[‡]



Jaguar's new colour palette has been developed to reflect the vitality and elegance of the vehicle. The Standard colours express a unique style and subtle sophistication. Jaguar also offers a further range of Premium finishes, as well as the exclusive Special selection colours. Racing Inspired finishes evoke Jaguar's formidable sporting heritage.

*Metallic paint
[†]Xirallic paint
[‡]Available on XFR

For availability please consult your local Jaguar dealer.

PREMIUM

Ultimate Black^{†‡}

Stratus Grey^{†‡}

Lunar Grey^{*†}

Rhodium Silver^{*†}

Cashmere^{*}

Crystal Blue^{*}





Indigo†

Caviar†

Claret*

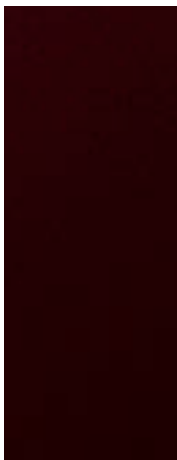

SPECIAL

Black Amethyst†

Kyanite Blue†
Unique to XFR



RACE INSPIRED

Italian Racing Red†
Unique to XFR

British Racing Green†
(Available from January 2012)



STANDARD FEATURES

ALL MODELS

POWERTRAIN AND DRIVING DYNAMICS

6-speed electronic automatic transmission with Jaguar Sequential Shift™ (Standard on all Petrol models)
8-speed electronic automatic transmission with Jaguar Sequential Shift™ (Standard on all Diesel models)
JaguarDrive Control™ with Dynamic Mode (Not available on XF 2.2 Diesel)
JaguarDrive Control™ with Winter Mode
JaguarDrive Selector™
Intelligent Stop/Start (Only available on XF 2.2 Diesel)
Servotronic Steering
Brake pad wear indicator
Cruise Control with Automatic Speed Limiter (ASL)
Electric Parking Brake (EPB)
Vented Disc Brakes, front and rear
DSC (Dynamic Stability Control) with Trac DSC mode
Traction Control

SAFETY AND SECURITY

Airbags, front and side (driver and front passenger)
Side curtain airbags
Anti-lock Braking System (ABS)
Pedestrian Contact Sensing System™ - automatically deployable bonnet system
Front seat whiplash reduction system
Front seat belts pre-tensioners
High level rear stop lamp
Cornering Brake Control (CBC)
Emergency Brake Assist (EBA)
Automatic Hazard Warning under heavy braking
Remote control central locking with deadlocking and drive-away locking function
Valet mode
3-flash lane change indicators
18" alloy space saver wheel

EXTERIOR FEATURES

Bi-function HID Xenon headlamps with LED daytime running lights
LED tail lamps
Diesel misfuelling protection device (Diesel models only)
Rain sensing windscreen wipers
Bright side window surrounds
Heated rear window with timer
Automatic headlamps with washers

INTERIOR FEATURES

Dual zone automatic climate control
Steering column with electric adjustment for height and reach with entry and exit tilt-away
Front centre console storage compartment
Two front and one rear auxiliary power sockets
Twin front and rear cup holders
Front and rear electric windows with one-touch open/close and anti-trap
Driver information centre with dual function trip computer
JaguarSense™ - overhead light console operation (front)
Phosphor blue halo illumination and interior mood lighting

INTERIOR TRIM

Rear centre head restraint
Leather 3-spoke steering wheel with Jaguar Sequential Shift™ paddles and remote controls for audio, cruise control, Bluetooth® telephone connectivity and Interactive Voice (where fitted)

MULTIMEDIA

3.5mm stereo auxiliary input socket
Bluetooth® audio streaming
7 inch colour Touch-screen
Front Media Interface with USB and iPod connectivity

TECHNICAL SPECIFICATIONS

ENGINES		2.2 LITRE 140KW DIESEL	3.0 LITRE V6 DIESEL AJ-V6D GEN III	3.0 LITRE V6 DIESEL S AJ-V6D GEN III S	3.0 LITRE V6 PETROL	5.0 LITRE V8 PETROL AJ-V8 GEN III	5.0 LITRE V8 PETROL SUPERCHARGED AJ-V8 GEN III R
Cylinders/Valves per Cylinder		4/4	6/4	6/4	6/4	8/4	8/4
Bore/Stroke	mm	85/96	84/90	84/90	89/79.5	92.5/93	92.5/93
Capacity	cc	2,179	2,993	2,993	2,967	5,000	5,000
Maximum power	kW	140	177	202	175	283	375
@rev/min		3,500	4,000	4,000	6,800	6,500	6,000-6,500
Maximum torque	Nm	450	500	600	293	515	625
@rev/min		2,000	2,000	2,000	4,100	3,500	2,500-5,500
Compression	ratio:1	15.8	16.0	16.0	10.5	11.5	9.5
Transmission		8-speed automatic	8-speed automatic	8-speed automatic	6-speed automatic	6-speed automatic	6-speed automatic
PERFORMANCE							
0-100 km/h	seconds	8.5	7.1	6.4	8.3	5.7	4.9
Top speed	km/h	225	240	250 limited	237	250 limited	250 limited
FUEL CONSUMPTION ⁽¹⁾							
Urban	l/100km	6.6	8.7	8.7	15.8	17.3	18.7
Extra Urban	l/100km	4.8	5.0	5.0	7.5	7.8	8.7
Combined	l/100km	5.4	6.3	6.3	10.5	11.1	12.5
Carbon dioxide emissions	g/km	149	169	169	249	264	292
Tank capacity	ltr approx.	69.5	69.5	69.5	69.5	69.5	69.5
Usable tank capacity	ltr approx.	64.0	64.0	64.0	64.0	64.0	64.0
WEIGHT ⁽²⁾							
Weight	kg	1,745	1,810	1,810	1,690	1,780	1,891
Gross vehicle weight	kg	2,320	2,360	2,360	2,215	2,300	2,370

⁽¹⁾All Fuel economy data has been measured in accordance with current Australian ADR 81/02 test procedures. Under normal use a vehicle's actual fuel consumption may differ from that achieved through the test procedure, depending on driving technique, road and traffic conditions, environmental factors and vehicle condition. If in any doubt, please consult your dealer; the information given is correct at the time of publication.

⁽²⁾Please consult your dealer for details of charges associated with option fitment. Weights reflect vehicles to standard specifications. Optional extras increase weight.

OPTIONAL FEATURES



JET SUEDECLOTH PREMIUM HEADLINING

The added luxury of a Jet Suedecloth premium headlining is available as an option on 3.0 V6 Diesel S Portfolio, 5.0 V8 Portfolio and the XFR models.



BLIND SPOT MONITOR

The Blind Spot Monitor uses side-mounted radar sensors to identify overtaking traffic and vehicles that cannot be seen in door mirrors or may be obscured. A bright amber warning icon illuminates in the appropriate door mirror when a hazard is detected to increase safety and driver awareness when changing lanes.



ADAPTIVE FRONT HEADLAMPS
WITH INTELLIGENT HIGH BEAM

Sensors react to the car's speed, steering input and environmental light conditions and smoothly alter the power, direction and spread of the beams to maintain optimal coverage whatever the situation. Adaptive Front Lights reduce glare and instil greater confidence in dark conditions.



REVERSE PARK CAMERA WITH GUIDANCE

A real benefit when manoeuvring in confined spaces where vision may be obscured, the system displays images from a discreet rear-facing camera on the Touch-screen and features coloured distance guides. The system can set guidance lines that are updated as the driver turns the wheel to indicate the area into which the car will reverse.

OPTIONS

IMPROVE ON PERFECTION

Jaguar offers an unrivalled range of enhanced specifications and customised features to make every XF uniquely individual. The extensive array of hand-picked extras offers the very best in luxury and performance that every driver can expect in a Jaguar.



OPTIONAL FEATURES

	LUXURY	PREMIUM LUXURY	XFS	LUXURY	PREMIUM LUXURY	PORTFOLIO	XFR		LUXURY	PREMIUM LUXURY	XFS	LUXURY	PREMIUM LUXURY	PORTFOLIO	XFR	
POWERTRAIN AND DRIVING DYNAMICS									SAFETY AND SECURITY							
	2.2 DIESEL AND 3.0 PETROL		3.0 DIESEL S	3.0 DIESEL 3.0 DIESEL S AND 5.0 PETROL			5.0 PETROL 375KW		2.2 DIESEL AND 3.0 PETROL		3.0 DIESEL S	3.0 DIESEL 3.0 DIESEL S AND 5.0 PETROL			5.0 PETROL 375KW	
Adaptive Cruise Control (ACC) with Intelligent Emergency Brake (IEB) *	O	O	O	O	O	O	O		Tyre Pressure Monitoring System (TPMS)	O	O	O	O	O	O	
EXTERIOR FEATURES									WHEELS							
Blind Spot Monitor (available only with Mirror Pack) (available with Interior Auto Dimming Mirror)	P	O	O	O	O	O	O		Refer to wheel matrix on pages 74-75 for optional wheel prices							
Heated windscreen with timer	O	O	O	O	O	O	O		18" alloy space saver spare wheel	●	●	●	●	●	●	
Adaptive Front Lighting and cornering lamps	O	O	O	O	O	O	O		19" alloy space saver spare wheel	-	-	-	-	-	●	
Electric glass sunroof with tilt/slide one touch operation	O	O	O	O	O	O	O		INTERIOR FEATURES							
Front parking aid with Touch-screen visual indicator	P	P	P	P	●	●	●		Electric rear window sunblind	O	O	O	O	O	O	
Reverse park camera with guidance	P	P	P	P	●	●	●		Jaguar Smart Key System™ with Keyless entry	O	●	●	●	●	●	
Red brake caliper option for Jaguar High Performance Braking System	-	-	-	-	-	-	O		Ski hatch (available only with 60/40 split folding rear seats)	O	O	O	O	O	O	
Intelligent high beam (available with Interior Auto Dimming Mirror)	O/P	O	O	O	O	O	O		60/40 split folding rear seats	O	O	O	O	O	O	
Chrome side power vents	O	O	O	O	O	O	O		Auto air recirculation	O	O	O	O	O	O	
Premium paint	O	O	O	O	O	NCO	NCO		MULTIMEDIA							
Special paint	O	O	O	O	O	O	O		Jaguar 600W premium sound system with CD and 11 speakers including 1 subwoofer†	O	O	O	O	●	-	
Race Inspired paint	O	O	O	O	O	O	O		Bowers & Wilkins 1200W premium sound system - upgrade from Jaguar 400W sound system	O	O	O	-	-	-	
INTERIOR TRIM									Bowers & Wilkins 1200W premium sound system - upgrade from Jaguar 600W premium sound system	-	-	-	-	O	O	-
Electric driver/passenger (6/6 way) seat adjustment with driver memory function	●	-	-	●	-	-	-		Digital/Analogue television**	-	-	-	-	O	O	O
Electric seats with driver/passenger adjustment (12/12 way)	O	O	O	O	-	-	-		Navigation system with HDD mapping, destination entry and voice guidance	O	●	●	●	●	●	●
Electric seats with driver/passenger adjustment (12/12 way) and driver memory function	O	O	O	O	O	-	-		Interactive Voice (requires Navigation)	O	O	O	O	O	O	
Active, ventilated front seats - heated/cooled**	-	-	-	-	O	●	●		PACKS							
Heated steering wheel (only where heated or heated/cooled seats are fitted)	O	O	O	O	O	●	●		Mirror Pack - auto dimming, powerfolding with approach lamps and auto dimming interior rear view mirror	O	-	-	-	-	-	
Front and rear carpet mat set	O	O	O	O	●	-	-		Front parking aid with reverse park camera with guidance	O	O	O	O	-	-	
Jet Suedecloth premium headlining	-	-	-	-	-	O	O		Interior Seating Pack - R style seats without logo 18/18 way Bond grain leather	-	O	O	O	-	-	
Jet Morzine headlining	O	O	O	O	O	-	-		Interior Seating Pack - R style seats without logo 18/18 way soft grain leather	-	-	-	O	O	-	
Bright metal foot pedals	-	P	P	P	P	P	O		Aerodynamic Pack	-	-	●	O	O	O	
Red Zone/Warm Charcoal Seats**	-	-	-	-	P	P	O		Aerodynamic Pack 2.2 Diesel	O	O	-	-	-	-	
Ivory Leather Seats**	-	-	-	-	P	P	O									
Veneer change	O	O	O	O	O	NCO	NCO									
Carbon Fibre veneer	-	O	O	O	O	O	O									

O Option ● Standard P Option as part of Pack O/P Option linked with a Pack NCO No Cost Option - Not available
 †Please consult your local Jaguar dealer for details. Please refer to the glossary for a more detailed description of features.

*Not available on 3.0 Petrol.

**For Premium Luxury this feature is only available on 3.0 Diesel.

†Standard on 3.0 Diesel Premium Luxury.

WHEEL OPTIONS



17" Libra



17" Ursa^Δ



18" Vela



18" Lyra



19" Caravela

XF LUXURY

2.2 Diesel	●	○	○	○	○
3.0 V6 Diesel	-	●	○	○	○
3.0 V6 Petrol	●	○	○	○	○
5.0 V8 Petrol	-	-	-	-	○

XF S

3.0 V6 Diesel S	-	-	-	-	-
-----------------	---	---	---	---	---

XF PREMIUM LUXURY

2.2 Diesel	-	●	○	○	○
3.0 V6 Diesel	-	-	●	○	○
3.0 V6 Petrol	-	●	○	○	○

XF PORTFOLIO

3.0 V6 Diesel S	-	-	-	-	●
5.0 V8 Petrol	-	-	-	-	●

XF R

5.0 V8 Supercharged	-	-	-	-	-
---------------------	---	---	---	---	---

● Standard ○ Option - Not available

[†]Requires alloy space saver when fitted

^ΔAvailable late 2011

Please consult your local Jaguar dealer for details.



19" Artura



19" Aquila



20" Hydrat



20" Draco Silver Finish†



20" Draco Dark Grey Finish†
(Diamond turned rim)



20" Nevist



20" Kalimnos Gloss Black Finish

○	○	○	○	○	-	○
○	○	○	○	○	-	○
○	○	○	○	○	-	○
-	-	●	○	○	-	○
-	●	○	-	○	-	○
○	○	○	○	○	-	○
○	○	○	○	○	-	○
○	○	○	○	○	-	○
○	○	○	○	○	-	○
-	-	-	○	○	●	-

ACCESSORIES

EXTERIOR STYLING



REAR VALANCE WITH XFR DIFFUSER
Striking gloss black rear valance integrating an XFR diffuser.
C2Z16211 & C2Z16212



REAR VALANCE WITH PERFORMANCE DIFFUSER
C2Z16211 & C2Z17681



CHROME SIDE POWER VENTS
Add style and visual distinction with chrome finish side power vents.
C2Z20383 & C2Z20384

AERODYNAMIC PACK

This pack provides a number of enhancements to the vehicle's rear, front and sides. Includes boot spoiler and modified front bumper, rear valance, diffuser and side sills to provide a distinctive new profile. Consult your Jaguar dealer for vehicle applicability.



TAILPIPE FINISHERS - CHROME

Chrome exhaust finishers add further style, sportiness and refinement to your XF. Not available for Supercharged derivatives.
C2Z18603



STYLED VALVE CAPS

Complete the look of your XF's wheels with custom valve caps. Available featuring 4 iconic designs.
Valve caps with Black Jack - C2D19598
Valve caps with Union Jack - C2D19599
Valve caps with Jaguar logo - C2D19596
Valve caps with 'R' logo - C2D19597



CENTRE WHEEL BADGE / WHEEL NUTS

A distinctive red wheel centre badge featuring the Jaguar logo that fits all available wheels. Enhance the look of your XF's wheels with Jaguar branded black or chrome wheel nuts.
Wheel centre badge - red - C2D12326
Wheel nut kit - chrome with Jaguar logo - C2D20072
Wheel nut kit - black with Jaguar logo - C2D20073

ACCESSORIES

EXTERIOR STYLING



CHROME MIRROR COVERS

Chrome mirror covers accentuate the stylish design of the exterior mirrors.

C2D5488 & C2D5489



SPLASH GUARDS

Front and rear Jaguar branded splash guards complement the lines of the XF and provide protection to the vehicle from dirt and stone chippings.

Front - C2Z7889

Rear - C2Z7890



18" VENUS
C2P1010



18" CYGNUS
C2Z3371



19" CARELIA
C2P12002



20" SENTA
Front - C2P1014
Rear - C2P1015



20" SELENA
C2P14975



20" VOLANS
Front - C2Z2652
Rear - C2Z2653

ALLOY WHEELS

A range of alloy wheels are available to purchase as accessories in addition to those listed as standard or optional.

See alloy wheel options page 74-75.

19" ARTURA
C2P14209

19" CARAVELA
Front - C2P12613
Rear - C2P12614

20" NEVIS
C2Z4429



20" SHADOW
VOLANS
Front - C2Z14680
Rear - C2Z14681

EXTERIOR UTILITY



ROOF CROSS BARS

Jaguar branded cross bars required for fitting all roof carrying equipment. Engineered specifically for your XF. C2Z20474

SKI/SNOWBOARD HOLDER

A safe and secure system for transporting winter sports equipment. C2A1538

WATERSPORT EQUIPMENT HOLDER

A versatile system for transporting a variety of water sports equipment including surfboard, kayak and sailboard. C2Z21730



CYCLE CARRIER

An easy to fit, lockable cycle carrier which carries one bicycle per holder. A maximum of three holders can be fitted to your XF. C2A1537

LUGGAGE FRAME

A spacious deck area with raised edges to ensure safe retention of luggage while travelling. (Not shown) C2A1536



ROOF BOX LUGGAGE

Spacious 440-litre capacity lockable roof luggage box, measuring 175x82x45cm. C2C41628

ROOF BOX SPORT

Spacious 420-litre capacity lockable roof box designed for sport equipment, measuring 206x84x34cm. C2C41627

TOWING ACCESSORIES

Detachable tow bar - C2Z5095
Towing electrics - 13 pin adaptor - C2Z21406
Towing electrics - towing electrics module - C2Z21516
Towing electrics - 12N 12S connector - C2Z21496
Towing electrics - 12N connector - C2Z21497

ACCESSORIES

INTERIOR STYLING



LUGGAGE COMPARTMENT FINISHER

This Jaguar branded finisher enhances the XF boot area. The finisher is made from stainless steel, has a brushed finish with bright highlights and adds aesthetic appeal as well as scuff protection.

C2Z5642



LUGGAGE COMPARTMENT PREMIUM CARPET MAT

Premium 2050 g/m² pile luggage mat in Jet with Jaguar logo inset, nubuck edging and Dove contrast stitch.

C2Z17858



ILLUMINATED SILL TREAD PLATES

Elegantly styled aluminium sill tread plates illuminate when the driver or passenger doors are opened. Highlighted by soft Phosphor blue lighting.

Warm Charcoal - C2Z5587LEG

Barley - C2Z5587SEL

Oyster - C2Z5587AMT



PREMIUM CARPET MAT SET

Luxurious, tailored 780 g/m² pile front carpet mat set with embossed Jaguar logo and nubuck edge binding. The premium mats provide a well appointed finishing touch to the interior. Available in the following colours:

Oyster with Ivory edge - C2Z8845AMT
Flint with Flint edge - C2Z8845LFN
Barley with Truffle edge - C2Z8845SEL



SPORT PEDAL COVERS

Made from stainless steel and rubber, the pedal kit fits securely over existing pedals for a contemporary, sporting appearance. C2D8416



LEATHER TOPPED GEAR SELECTOR

A specially designed gear selector with premium dark leather finished top and rubber bezel with soft touch grip. C2D21919PVJ & C2D21956

ACCESSORIES

INTERIOR UTILITY



LUGGAGE COMPARTMENT SIDE NET (PAIR)

Side net providing additional enclosed stowage in the luggage compartment and help to secure loose items such as bags or small parcels.

C2Z21494

SMOKER'S PACK

Premium finish ashtray and cigar lighter fit into the centre cup holder space. (Not shown)

C2Z16011 & C2C11315



LUGGAGE COMPARTMENT LINER

Fitted semi-rigid rubber liner to protect the floor of the luggage compartment.

C2Z5613



REAR SEAT ENTERTAINMENT

This is an integrated Rear Seat Entertainment system. The kit has replacement headrests with built in 7 inch screens, two sets of infra red headphones and an input panel located at the rear of the centre console allowing connectivity of various devices including portable video/DVD players, games consoles and laptops. This product is available for fitment to Warm Charcoal and Barley interiors only. Manual headrest functionality only.

Warm Charcoal - C2Z12288LEG

Barley - C2Z12288SEL

CAR CARE & MAINTENANCE



RUBBER FOOTWELL MATS

Hardwearing Jaguar branded rubber mats provide added protection for your XF's carpets.

Rear - C2Z5612

Front - C2Z15681



ALL-WEATHER CAR COVER

All-weather tailored cover for the XF with the Jaguar logo. Protect your XF from the elements, including showers, frost and dust. Quick and easy to fit.

C2Z6574

LOCKING WHEEL NUTS
C2C9198

BULB KIT
C2Z6140

WARNING TRIANGLE
C2S20992

GLOSSARY

POWERTRAIN AND DRIVING DYNAMICS

ACTIVE DIFFERENTIAL

An electronically controlled, active differential with Handling Functionality that limits the slip between the rear wheels to optimise traction and stability in different driving conditions, working in harmony with the Traction, ABS and DSC systems.

ADAPTIVE DYNAMICS

Provides the optimum balance between low speed ride comfort and high speed handling precision, analysing body movement, steering and road wheel inputs up to 500 times a second and continuously adjusts the suspension settings through electronically controlled dampers.

DSC (DYNAMIC STABILITY CONTROL)

Intervenes in demanding driving situations by applying braking to individual wheels and reducing engine torque.

TRAC DSC MODE

Provides a higher intervention threshold for the more enthusiastic driver.

JAGUAR SEQUENTIAL SHIFT™

Provides the choice of Drive, Sport Automatic or Manual gearshift modes, with one touch paddles mounted behind the steering wheel to control gear changes up and down manually.

JAGUAR DRIVE CONTROL™

Interacts with the DSC (Dynamic Stability Control) engine and transmission management systems to change the characteristics of engine mapping, transmission shifts and brake interventions. It offers different modes selectable by a button to optimise the vehicle response depending on driving conditions and style.

WINTER MODE

Softens the responsiveness of the engine and modifies the gear change strategy to maintain optimum traction in icy or slippery conditions. The vehicle performs in a more gentle and controlled manner, allowing more confident progress. When active, Winter Mode selects 2nd gear for pulling away on level ground (no incline).

DYNAMIC MODE

Optimises vehicle systems to deliver a more involving driving experience. When selected, Trac DSC is automatically engaged, and engine torque delivery characteristics and gear shift points are modified to further improve responsiveness. When selected while the transmission is in full manual mode, transmission up-shifts are fully controlled by the driver, with no automatic up-shift when the rev limit is reached.

CRUISE CONTROL WITH AUTOMATIC SPEED LIMITER (ASL)

In tandem with cruise control, an Automatic Speed Limiter (ASL) allows the driver to select a maximum speed that should not be exceeded.

ADAPTIVE CRUISE CONTROL (ACC) WITH INTELLIGENT EMERGENCY BRAKE (IEB) AND ACTIVE SEAT BELTS

Uses microwave radar technology to monitor for slower moving traffic and can alert the driver to potential hazards ahead. Using the ACC radar, the system calculates distance and speed of approach to the vehicle in front and if a collision is unavoidable, the Intelligent Emergency Brake reduces vehicle impact speed by initiating an emergency brake manoeuvre. The system incorporates Active Seat Belts to reduce occupant displacement from the seat during the emergency braking manoeuvre.

EXTERIOR FEATURES

MIRROR PACK

Heated exterior mirrors with electric adjustment, power folding, approach lamps and auto-dimming exterior and interior rear view mirror.

REAR PARKING AID

Rear parking aid with Touch-screen visual indicator.

FRONT PARKING AID

Front parking aid with Touch-screen visual indicator.

REVERSE PARK CAMERA WITH GUIDANCE

Combines a rear-facing camera with the Touch-screen information, it features coloured distance guides and on-screen guidance lines that move according to steering wheel angle to indicate the area into which the car will reverse.

ADAPTIVE FRONT LIGHTING

Sensors react to the car's speed and steering input, and the system can deflect headlamp beams casting light deeper into the corners, and giving added confidence at night.

INTELLIGENT HIGH BEAM

When sensing preceding, oncoming traffic or street lights, the headlamps will automatically to low beam, maximising driver visibility and appropriate beam useage. The system automatically switches to high beam when the oncoming car has passed.

BLIND SPOT MONITOR

Uses radar sensors to remotely cover areas that cannot be seen either directly or by mirror, and alerts of overtaking traffic with an amber warning icon in the external mirrors.

INTERIOR FEATURES

JAGUARSENSE™

An electronic control system that operates the front overhead console lights by touch.

JAGUAR SMART KEY SYSTEM™ WITH KEYLESS ENTRY AND KEYLESS START

With the Jaguar Smart Key in your pocket or bag, the car automatically unlocks as you pull the door handle. Simply push the ignition button to start the engine. Upon leaving, simply press a button on the door handle to lock the car or use the Jaguar Smart Key.

INTELLIGENT STOP/START

Stop/Start is a technology that stops the engine when it is not needed, improving the fuel economy and reducing the car's CO₂ emissions. The engine will restart immediately as soon as the driver foot comes off the brake pedal. The engine will be operating at full capacity before the driver's foot has touched the accelerator pedal.

DUAL ZONE CLIMATE CONTROL

With humidity control, air filtration and dual temperature control for driver and passenger.

AUTO RECIRCULATION - CLIMATE CONTROL

Automatic cabin air recirculation triggered by external odour sensor with 5 sensitivity settings.

SEATS (4/4 WAY)

Driver and passenger electric adjustment including recline and height.

SEATS (6/6 WAY)

Driver and passenger electric adjustment including fore/aft, recline and height. Memory function optional.

SEATS (10/6 WAY)

Driver's electric adjustment including fore/aft, height, recline, cushion tilt, 2-way lumbar support, and passenger's electric adjustment including fore/aft, height, and recline. Also includes memory function.

SEATS (12/12 WAY)

Driver and passenger electric adjustment including fore/aft, height, recline, cushion tilt and 4-way lumbar support.

SEATS (16/12 WAY)

Driver's electric adjustment including fore/aft, height, cushion tilt, recline, headrest height, 4-way lumbar support, cushion length and passenger's electric adjustment including fore/aft, height, cushion tilt, recline, and 4-way lumbar support. Also includes memory function.

SEATS (18/18 WAY)

Driver and passenger electric adjustment including fore/aft, height, recline, cushion tilt, cushion length, 4-way lumbar support, headrest height and adjustable side bolsters.

MEMORY FUNCTION

2 settings for driver's seat, exterior mirrors and steering column.

SAFETY AND SECURITY

PEDESTRIAN CONTACT SENSING SYSTEM™

Automatically deployable bonnet system. Industry-leading system that senses an impact between a pedestrian and the front of the car, it instantaneously raises the bonnet through a small distance in a very controlled way, to help prevent the pedestrian from contacting hard points under the bonnet.

MULTIMEDIA

NAVIGATION SYSTEM WITH HDD MAPPING⁽²⁾

With front DVD and virtual multi-changer system, providing faster access to data including voice guidance and voice control input. The navigation system also includes a front DVD capable of playing video and audio. File formats include Windows Media Audio (WMA), ACC and MP3. In addition there is a virtual multi-changer that uses the hard disc drive (HDD) for storage of up to 10 CDs of uncompressed music.

WINDOWS MEDIA AUDIO (WMA) AND MP3 COMPATIBILITY

Enables the CD player to play CDs which contain WMA and MP3 files.

BLUETOOTH® AUDIO STREAMING⁽³⁾

A Bluetooth® equipped Jaguar enables hands-free use of your mobile phone at any time when the phone is in the car, through the Touch-screen. Bluetooth® also provides the ability to stream audio content, and full function control enables easy track selection. Bluetooth® is compatible with a selected range of mobile phones from most manufacturers, including Apple, Blackberry® and HTC - ask your local Jaguar dealer or visit jaguar.com.au for more details.

INTERACTIVE VOICE™

Uses 'Say What You See' technology to guide the user to the correct commands for voice control of audio, Bluetooth® audio streaming and navigation. When in operation, as well as audio prompts, all commands appear on the Touch-screen.

FRONT MEDIA INTERFACE⁽⁴⁾

Allows the connection of an iPod, MP3 player or a USB Mass Storage Device to the in-car sound system and control via the 7 inch colour Touch-screen.

7 INCH COLOUR TOUCH-SCREEN

With controls for audio, climate control, Bluetooth® audio streaming (where fitted) and Navigation (where fitted).

JAGUAR 400W SOUND SYSTEM

400W system with AM/FM radio featuring EON, RDS, PTY, TA and single slot CD with automatic volume control, MP3 compatibility and 10 speakers.

JAGUAR 600W PREMIUM SOUND SYSTEM

With AM/FM radio featuring EON, RDS, PTY, TA and single slot CD with automatic volume control, MP3 compatibility and 11 speakers including subwoofer.

BOWERS & WILKINS 1200W PREMIUM SOUND SYSTEM

With AM/FM radio featuring EON, RDS, PTY, TA and single-slot CD with automatic volume control, MP3 compatibility, a remote amplifier with Dolby® Pro Logic® II Surround Sound and 17 speakers including subwoofer.

EXTERIOR THEMES

DIESEL S EXTERIOR THEME

Restyled front bumper with black grille, side sill extensions, rear boot lid spoiler, sculpted lower air intake blades, restyled valance and S badging on boot lid.

R EXTERIOR THEME

Unique deeper section front bumper with larger lower air intakes, black mesh grille, side sill extensions, aerodynamic boot lid spoiler, gloss black sculpted rear valance with three vanes and quad exhaust tailpipes. 'Supercharged' embossed bonnet louvres for additional cooling. Silver-grey brake calipers with Jaguar script and R badge on boot lid and front grille.

BLACK PACK

The Black Pack consists of a high Gloss Black finish to the window surround, front grille and surround, bumper aperture inserts, body coloured rear signature blade and a painted rear bumper lower valance* (*available on XFR only).

INTERIOR THEMES

R INTERIOR THEME

Unique sport themed interior incorporating a dark mesh aluminium finish on instrument panel and doors, Dark Oak veneer, Warm Charcoal upper fascia and lower environment with contrast stitching and carpet mat edge binding (colour dependent on seat colour). Sports seats with embossed R logo (front and rear); R badging on steering wheel and instrument panel; instrument cluster dials with red pointers.

WHEEL SPECIFICATIONS

	FRONT	REAR
17" Libra alloy wheels	7.5J x 17"	7.5J x 17"
17" Ursa alloy wheels	7.5J x 17"	7.5J x 17"
18" Lyra alloy wheels	8.5J x 18"	8.5J x 18"
18" Vela alloy wheels	8.5J x 18"	8.5J x 18"
19" Aquila alloy wheels	8.5J x 19"	8.5J x 19"
19" Caravela alloy wheels	8.5J x 19"	8.5J x 19"
19" Artura alloy wheels	8.5J x 19"	8.5J x 19"
20" Hydra alloy wheels	8.5J x 20"	8.5J x 20"
20" Nevis alloy wheels	8.5J x 20"	9.5J x 20"
20" Draco Dark Grey Finish alloy wheels	8.5J x 20"	8.5J x 20"
20" Draco Dark Grey Finish alloy wheels (XFR)	8.5J x 20"	9.5J x 20"
20" Draco Silver Finish alloy wheels	8.5J x 20"	8.5J x 20"
20" Draco Silver Finish alloy wheels (XFR)	8.5J x 20"	9.5J x 20"
20" Gloss Black Kalimnos alloy wheels	8.5J x 20"	8.5J x 20"

^①Alloy space saver required when 20" wheels specified.

^②The Navigation system must always be used in conditions that will not affect the driver's ability to drive safely or affect the safety of other road users.

^③The Bluetooth® word mark and logos are owned by the Bluetooth SIG, Inc. and any use of such marks by Jaguar Cars Limited is under license.

^④iPod is a trademark of Apple Inc., registered in the U.S. and other countries.

XF OWNERSHIP EXPERIENCE

SERVICE, ASSURANCE, AND PEACE OF MIND ARE ALL PART OF THE PRIDE OF OWNING YOUR XF.

THE JAGUAR ACCESSORY RANGE

Enabling you to personalise your car, to create a driving experience that is even more individually rewarding. All Jaguar accessories are tested rigorously for safety and durability in the most arduous of climates and conditions.

A comprehensive range of styling options, interior and exterior accessories, enabling you to tailor your XF to suit your personal style.

BECAUSE ONLY THE BEST WILL DO

An official Jaguar dealer can ensure that Jaguar trained, specialist technicians, with access to the full range of Jaguar approved parts and tools, will always be on hand to guarantee that every fitting, or repair, is carried out exactly the way Jaguar intended. Your Jaguar dealer can also supply and fit Jaguar approved accessories to personalise and add to the practicality and style of your XF model.

JAGUAR ROADSIDE ASSISTANCE†

All Jaguar vehicles purchased in Australia benefit from complimentary Jaguar Roadside Assistance service for the length of the new car warranty. This covers you Australia-wide 24 hours per day, every day.

WARRANTY*†

3 year/100,000km* mechanical warranty together with a 3 year unlimited kilometre Paint Surface Warranty and 6 year unlimited kilometre Corrosion (Perforation) Warranty.

JAGUAR MAGAZINE

Bringing to life Jaguar's racing heart, Jaguar Magazine is our owner publication. It combines features on our legendary performance, the inside track on our products and company, along with news and events from the world of Jaguar.

JAGUAR.COM.AU

Dedicated to you and your XF, the interactive jaguar.com.au website features helpful tools such as the dealer locator, model specifications - allowing you to see the car tailored to your specification and colour; the latest information on all the Jaguar models and a fascinating look into the passion and legacy that infuse the Jaguar name.

*Whichever is the earliest.

†Terms and Conditions apply. Please contact your Jaguar dealer for more information.

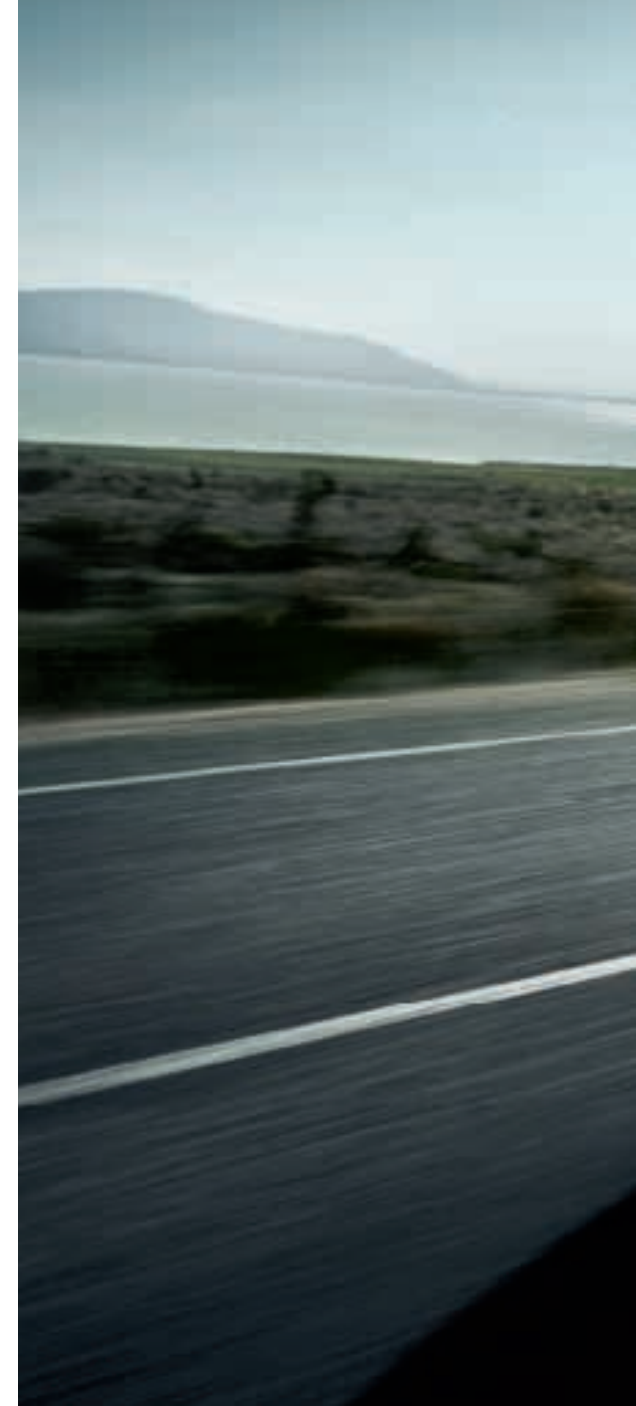



JAGUAR



BY APPOINTMENT TO
HER MAJESTY THE QUEEN
MANUFACTURERS OF
CARS AND JAGUAR CARS
JAGUAR CARS LIMITED COVENTRY



BY APPOINTMENT TO HER MAJESTY
THE QUEEN THE PRINCE OF WALES
MANUFACTURERS OF
CARS AND JAGUAR CARS
JAGUAR CARS LIMITED COVENTRY

PREVIOUS APPOINTMENT TO THE LATE QUEEN ELIZABETH THE QUEEN MOTHER 1964 - 2002

IMPORTANT NOTICE

Jaguar Cars Limited is constantly seeking ways to improve the specification, design and production of its vehicles and alterations take place continually. Whilst every effort is made to produce up-to-date literature, this brochure should not be regarded as an infallible guide to current specifications. Jaguar Australia reserves the right to alter these specifications at any time. This brochure does not constitute an offer for the sale of any particular vehicle. Distributors and dealers are not agents of Jaguar Cars limited and have absolutely no authority to bind Jaguar Cars Limited by any express or implied undertaking or representation, illustrations in this brochure may include optional extras.

Comparisons are based on manufacturer's own data and testing.

ENVIRONMENTAL NOTICE

Jaguar cars Limited has a vision of being amongst the world's leading companies in demonstrating progress towards sustainability. We aim to do this by contributing to a better quality of life, with corporate citizenship at the very heart of our company. Environmental responsibility is a core value in Jaguar, and it is our policy to continually improve our environmental standards in all areas of business activity.

The Bluetooth® word mark and logos are owned by the Bluetooth SIG, Inc. and any use of such marks by Jaguar Cars Limited is under license.

iPod, iPod touch and iPad are trademarks of Apple Inc., registered in the U.S. and other countries.

BlackBerry® is a trademark of Research In Motion Limited and is registered in the U.S. and may be pending or registered in other countries.

Dolby and Pro Logic are registered trademarks of Dolby Laboratories.

DTS™ is a registered trademark of DTS Inc. and any use of such marks by Jaguar Cars Limited is under license.

Audyssey MultEQ® is a registered trademark of Audyssey Laboratories, Inc. and any use of such marks by Jaguar Cars Limited is under license.

WhiteFire® is a registered trademark of Unwired Technology LLC and any use of such marks by Jaguar Cars Limited is under license.

Bowers & Wilkins is a registered trademark of B&W Group Limited.

Jaguar Australia Locked Bag 2213
North Ryde NSW 1670
Phone: 1800 450 683 or 02 9020 1400
Fax: 02 9020 1794
Jaguar.com.au



JAGUAR.COM.AU