



**GRAND  
CARNIVAL**



The Power to Surprise



## A real crowd pleaser

The Kia Grand Carnival has the room to move you, your entourage and all their gear, in comfort and style.

# It's your life and it's a Carnival

Anyone who's ever tried getting a family of eight around town knows it can be a circus. Which is why Kia designed the Grand Carnival. Helping meet the hectic demands of modern family life, the Grand Carnival is a truly multi-purpose vehicle.

With its versatile 2+3+3 seating design, the Grand Carnival has the room to move your entourage in style and comfort. What's more, you're surrounded by user-friendly features from every seat.

—  
You'll find ample head and leg room even when you carry eight people in the spacious Grand Carnival.

Packed full of innovative practicality, the Grand Carnival has been ergonomically designed to cater for all kinds of trips with the entire family. Plus you'll find plenty of spare room for their luggage, sports gear, and also the family pet.

In fact, virtually every square centimetre of the Grand Carnival has been designed with a practical purpose in mind - whether it's for storage space or comfort, the Grand Carnival's got it all.



Platinum model shown





Versatile seating.  
With a quick tug of a strap, you can fold and stow away the third-row seats, which fold neatly into the floor. Flat folding seats can create more room for transporting cargo and luggage.

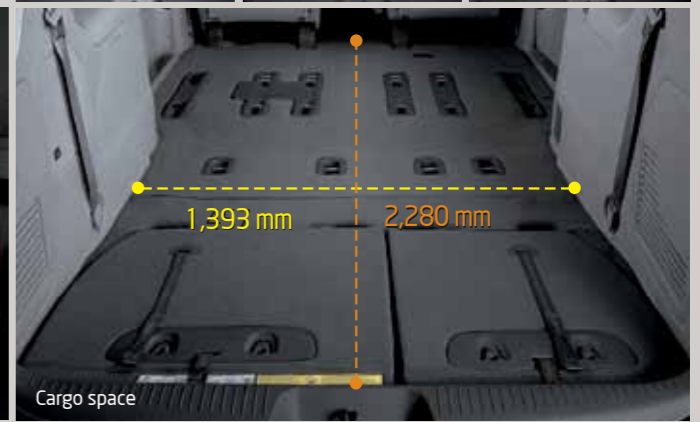
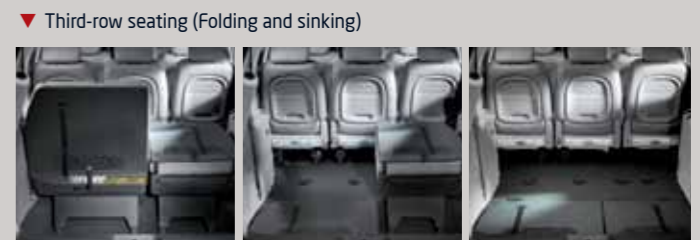

## All the space you'll ever need

You're never short of space in the Grand Carnival. Its one-touch double folding seats in the second-row not only create easy access to the third-row of seats, they can also be easily removed to expand the rear cargo space. Plus, the third-row seats fold flat and collapse into the floor, for when you need some extra luggage space.



## The power to keep up with a busy family

At the heart of the Grand Carnival is an incredibly powerful 3.5L V6 CVVT (Continuous Variable Valve Timing) petrol engine with aluminium block design or a fuel-efficient 2.2L CRDi diesel engine. Both powerplants have been designed with the latest technological advancements to ensure you have the right amount of power and torque, even when every seat is occupied. While at the same time, delivering a quiet and eco-friendly ride.

The clever 6-speed Sportsmatic-style auto transmission features fuzzy-logic intelligence for processing information on driving styles and conditions, and an advanced powertrain control unit for smoother gear shifting.

3.5L V6 engine

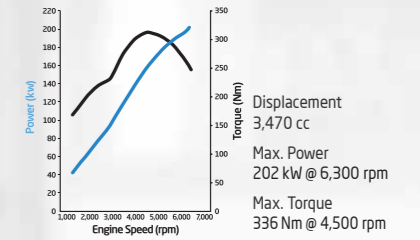

2.2L CRDi engine

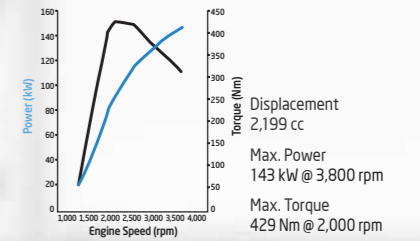

# Safeguard your most precious cargo

Safety has always been Kia's number one consideration in the development of the Grand Carnival. To help protect your passengers and provide peace-of-mind, the Grand Carnival features an abundance of advanced active and passive safety systems, including life-saving ESC (Electronic Stability Control) with TCS (Traction Control System), ABS brakes, six airbags, as well as rear parking sensors (Platinum only) and rear view camera. (SLi & Platinum only)

State-of-the-art safety features such as ESC help maintain control under unexpected road conditions, and incorporates TCS and Brake Assist System, which enhances the ABS to give you maximum stopping power without skidding.

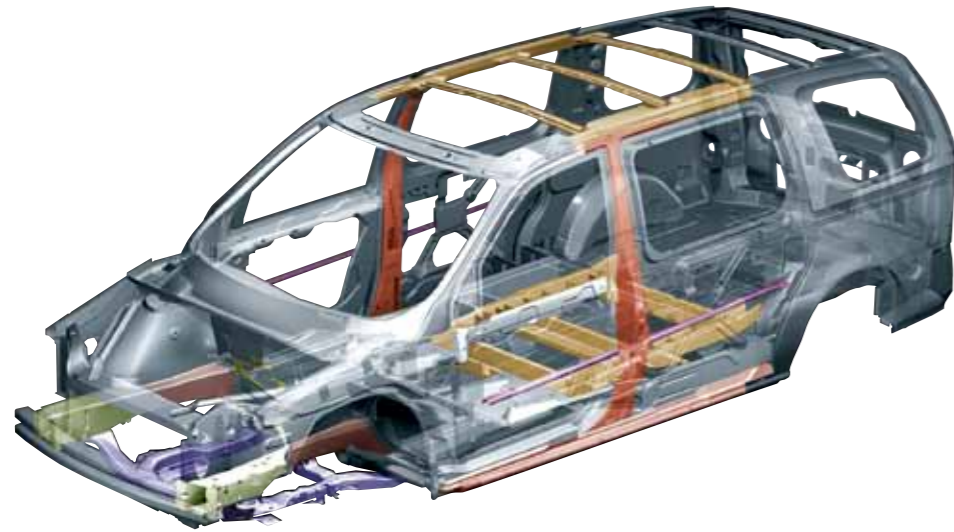

The Grand Carnival's rigid steel frame creates a safety cell that absorbs impact energy, with front and side collision protection at every important point to help protect passengers in the event of an impact.

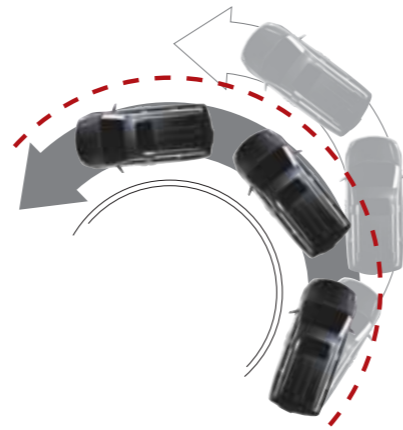

When sensors monitoring steering angle and wheel speed detect a potential skid, ESC (Electronic Stability Control) adjusts power and brake distribution to help keep you on course.

The many safety features in Carnival, from the wheels and chassis to interior airbags, combine to make it an extremely safe place to be, whether you're the driver or passenger.

A second line of protection is offered by six state-of-the-art airbags. Front dual and side airbags help protect the driver and passenger from front and side collisions. While roof-based side-curtain airbags provide protection for the head of the passengers in the first and second rows.



Overhead sliding door buttons



Sliding door buttons



▼ Dual power sliding doors (SLi & Platinum models)  
The rear dual power sliding doors are operated with a touch of the remote key or switches in the overhead console, and include a manual override and obstacle detection for complete safety.



Overhead tailgate button



Tailgate inner button



◀ Power tailgate (Platinum model only)  
For every shopper's delight, the tailgate is power-operated with the remote key, overhead console switch in the cabin or button on the tailgate trim.



## Lifestyle-friendly



Cluster: The stylish in-dash gauge cluster is much more than a sophisticated piece of design. It is placed in a way that emphasizes simplicity and cleanliness, allowing the driver to quickly scan basic information such as RPM and fuel or the digital trip counter.



Radio + CD player + MP3 audio system: Kia's own audio engineering talent and expertise delivers a sound system that is as luxurious and high performing as the Grand Carnival itself. Both the SLi and Si models feature a single CD player, while the Platinum model includes a convenient six CD stacker.



Automatic climate control system: The Grand Carnival's fully automatic climate control system comes with air quality control to reduce dust, pollen and pollutants in the cabin. At the touch of a button the interior climate will automatically adjust to your preferred temperature. (Platinum model only)



Power driver seat: It is vital that the driver achieves the perfect posture for a relaxed trip, and the Grand Carnival includes an electrically powered seat to help you achieve pin-point seating perfection. (Platinum model only)



Conversation mirror: The conversation mirror is a clever and popular innovation that brings driver and passenger together. It allows the driver to see everything that's going on in the back without taking their eyes off the road.



Rear manual climate control: For the comfort of second-row passengers, there's a rear manual climate control for controlling temperature and fan settings. The air vents can be independently adjusted to make every journey as comfortable as possible. (Si, SLi & Platinum model shown)



▲ Keyless entry system  
The keyless entry system allows you to open or close the doors. A separate button opens or closes the tailgate. (Platinum key shown)

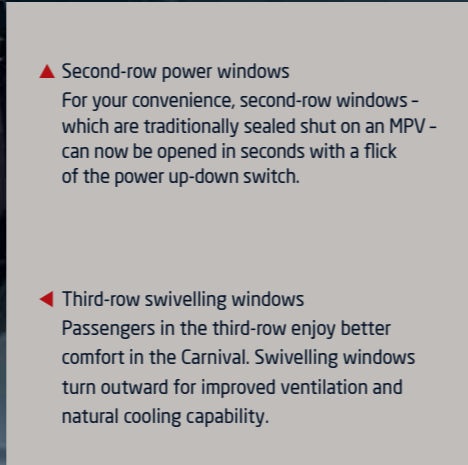

▲ Second-row power windows  
For your convenience, second-row windows - which are traditionally sealed shut on an MPV - can now be opened in seconds with a flick of the power up-down switch.

◀ Third-row swivelling windows  
Passengers in the third-row enjoy better comfort in the Carnival. Swivelling windows turn outward for improved ventilation and natural cooling capability.



Driver control panel: The driver's control panel includes power window switches as well as central door locking switch and power window lockout - a safety feature that parents of small children will appreciate. (Si, SLi & Platinum model shown)



Heated side view mirrors: Condensation, ice and even snow can affect driving visibility, but Kia has the answer. The heated side view mirrors will clear the glass to ensure you have 100% visibility. (Si, SLi & Platinum model shown)



You can make phone calls and chat with friends like they were right there with you in the Grand Carnival, with the added convenience of Bluetooth® hands-free connectivity.



Rear storage box: Passengers who travel with earphones, books, maps and other essentials can neatly stow their gear away in the rear storage box. Its containment lid also doubles as a twin drinks holder.



Electrochromic mirror / Reverse camera: The Electrochromic mirror automatically dims any glare from a car's headlights behind. While the rear-view camera cleverly mounted in the rear-view mirror displays any objects behind while reversing. (SLi and Platinum models)



Rear Parking Sensors: Children and low-lying obstacles can be difficult to see when reversing. Sensors within the bumper will alert you to the distance from objects at the rear with an audio warning. (Platinum model only)

## Body colour

Make your own statement with the body colour options on your Grand Carnival, with seven shades to choose from.



Clear White



Bright Silver#



Cherry Cocktail Red#



Platinum Graphite#



Latte#



Crystal Blue#



Aurora Black#

# Premium paint

## Wheels

You can opt for the 6 spoke 16-inch steel or alloy wheels or the premium 17-inch alloy wheels for the ultimate appeal.



235 / 60R 17" Alloy Wheel (SLi and Platinum models).



225 / 70R 16" Alloy Wheel (Si model).



225 / 70R 16" Wheel Cover (S model).

## Dimensions (mm)

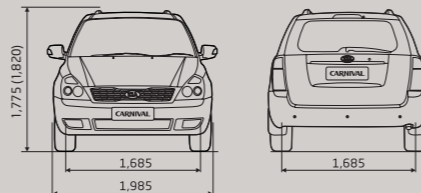
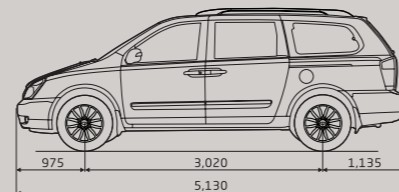

LWB: Long Wheel Base.

## Specifications

Dimensions (mm)	LWB	LWB	LWB
Overall length	5,130	Interior width	1,700
Overall width	1,985	Interior height	1,260
Overall height (Including roofrack)	1,775 (1,820)	1 <sup>st</sup> Headroom	1,041
Wheelbase	3,020	2 <sup>nd</sup> Headroom	979
Wheeltrack (Front)	1,685	3 <sup>rd</sup> Headroom	974
Wheeltrack (Rear)	1,685	1 <sup>st</sup> Shoulder room	1,606
Overhang (Front)	975	2 <sup>nd</sup> Shoulder room	1,660
Overhang (Rear)	1,135	3 <sup>rd</sup> Shoulder room	1,537
Interior length	2,785	1 <sup>st</sup> Legroom	1,059
		2 <sup>nd</sup> Legroom	937
		3 <sup>rd</sup> Legroom	927
		Interior volume 1 <sup>st</sup> (litres)	1,770
		Interior volume 2 <sup>nd</sup> (litres)	1,530
		Interior volume 3 <sup>rd</sup> (litres)	1,390
		Cargo volume (litres)	912
		Min. Ground clearance	167
		Fuel tank capacity (litres)	80

## As eco-conscious as you are

So you value sustainable living? We do too. That's why we take pride in rising to meet the expectations and challenges of the 21st century while making tangible contributions to the preservation of the environment and sustainable development of society.

We set up an environmental research centre to spearhead our drive for the production of clean hybrid and fuel-cell vehicles to lead the way to eco-friendly cars for a greener tomorrow for you, your children and our planet.

The concept of eco-friendly cars is adhered to throughout all cycles of a vehicle's life.

From design through to recycling, we create innovative products, ensuring state-of-the-art design for recycling (DfR) guidelines. Wherever possible, recycled and recyclable materials are being used in the production of every Kia.

Even at the end of your car's life, one of our environmental targets is the eco-friendly return and treatment of end-of-life vehicles.

Operating a rigid process, we guarantee environmental protection in the treatment of harmful waste substances. These are then recycled or recovered, ensuring the highest level of environmental protection.

As you can see, what you do on a small scale with your household recycling, we at Kia Motors do on a large scale with the vehicles we produce.



S model shown





The Power to Surprise

Kia Motors Australia  
350 Parramatta Rd, Homebush, NSW, 2140

[www.kia.com.au](http://www.kia.com.au)

Kia is the newest and most exciting force of change in the automotive world and we are ready to change the way you feel and think about driving. More than just a promise, we are committed to making driving a true pleasure for customers across the globe. With youthful styling and the latest in advanced technologies, Kia cars are turning heads the world over with the power to surprise. From the Rio to the Sorento, Kia offers a full lineup of sedans, SUVs and MPVs that are not only practical but downright exhilarating to drive. Keep your eyes on Kia because our best has yet to come.

**About Kia Motors Corporation**

Kia Motors Corporation ([www.kia.com.au](http://www.kia.com.au)) -- a maker of quality vehicles for the young-at-heart -- was founded in 1944 and is Korea's oldest manufacturer of motor vehicles. As part of the Hyundai-Kia Automotive Group, Kia aims to become one of the world's premier automotive brands. Over 2 million vehicles a year are produced in 13 manufacturing and assembly operations in eight countries which are then sold and serviced through a network of distributors and dealers covering 172 countries. Kia today has over 44,000 employees worldwide and annual revenues of over US\$20 billion. It is the major sponsor of the Australian Tennis Open and an official automotive partner of FIFA -- the governing body of the FIFA World Cup. Kia Motors Corporation's brand slogan -- "The Power to Surprise" -- represents the company's global commitment to surpassing customer expectations through continuous automotive innovation.

Unlimited km 5 year warranty. Note: 5 year/130,000km warranty for vehicles used for the following: rental vehicles, hire cars, taxis, courier vehicles, driving school vehicles, security vehicles, bus and tour vehicles.

