

# RANGE ROVER SPORT



ABOVE AND BEYOND



## RANGE ROVER SPORT 2015

Range Rover Sport was designed to be driven. The fastest Land Rover ever, its breathtaking performance is matched only by its distinctive design. Range Rover Sport also features new innovations such as InControl™ Apps. This optional feature enables you to optimize smartphone apps on the vehicle's Touch-screen. The option of a Hybrid engine is also available, that delivers powerful, responsive driving on-road and full capability off it.



DESIGNED TO BE DRIVEN

An introduction to Range Rover Sport

Page 2



## SPECIFICATION

A true expression of your individuality

Page 20





Range Rover Sport; the most agile, dynamic and responsive Land Rover. Born from a relentless drive to create a contemporary yet authentic design, its streamlined front elevation and rearward sloping grille gives the vehicle immense road presence. With seductive flowing lines and styling, the sophisticated design of the vehicle is conveyed without compromising its character.



Settle back into the driver's seat of the Range Rover Sport and one thing is immediately apparent; it demands to be driven. The Sports Command Driving Position gives you an unparalleled view of the road ahead. The high centre console and a low centre of gravity make you feel connected to the road.









With over 65 years of all-terrain expertise, this vehicle has Land Rover capability at its heart. Using the latest technology such as Terrain Response® 2, the Range Rover Sport automatically recognises and optimises the settings for the current conditions, delivering unrivalled performance on and off-road.





A Land Rover's unrivalled breadth of capability has never been in question and the Range Rover Sport builds on those qualities with ease. Whether you're manoeuvring around tight corners or negotiating the traffic, the vehicle is surprisingly agile and has all the right credentials to help you manage any situation. Features like Hill Descent Control automatically help emphasise that sense of a relaxed and stress-free drive no matter what the situation.



Confident and composed, Range Rover Sport is the fastest, most responsive Land Rover ever. It has been engineered to incorporate the latest developments including new and enhanced chassis technologies. Powertrains such as the 4.4 litre LR-SDV8 Diesel deliver a staggering 740Nm. Whilst Range Rover Sport Hybrid delivers greatly reduced emissions and improved fuel economy without loss of performance. The vehicle truly is 100% Hybrid, 100% Land Rover.







Range Rover Sport has been designed and engineered to meet the needs of today. It is equally at home in the city, the back of beyond or powering down the autobahn. It has been superbly conceived and created. And those personal touches that you can include in your specifications help create a heightened sense of individuality.

Interior shown left is Autobiography with Dynamic Pack in Ebony / Lunar.  
Vehicle shown above is HSE in Corris Grey.







Inside the Range Rover Sport the latest innovations have been incorporated to deliver complete comfort, enjoyment and exhilaration. These include an advanced Meridian™ sound system, Touch-screen with satellite and digital TV, optional rear seat entertainment with Touch-screen remote control and WhiteFire® digital wireless headphones.

The spacious rear seating package and option of two hidden seats provide improved versatility and comfort. The generous selection of interior finishes embody the individuality and understated confidence of our customers. A full-size sliding panoramic roof allows light to pour into the cabin.

Interiors shown left and above are Autobiography with Dynamic Pack in Ebony / Lunar.

WhiteFire® is a registered trademark of Unwired Technology LLC and any use of such marks by Land Rover is under licence.



Strength is nothing without control. Range Rover Sport features an advanced aluminium body and lightweight front and rear suspension. Torque Vectoring delivers more responsive, controlled cornering and handling through even the tightest of bends. And Adaptive Dynamics delivers continuous variable damping for balanced, dynamic handling. Range Rover Sport truly puts the 'S' in SUV.





Range Rover Sport's interior is meticulously fashioned to its sporting character. Superb detailing, strong elegant lines and clean surfaces combine with luxurious soft-touch finishes. Intuitively placed instruments, such as the CommandShift® 2, create a cabin that places the driver at its centre. The finest materials and an obsessive eye for detail have helped shape this comfortable yet purposeful space.

Contemporary. Beautifully designed. Flawlessly executed.

Interior shown above is Autobiography in Ebony / Lunar.  
Vehicle shown right is Autobiography in Corris Grey.



# NOW IT'S TIME TO CHOOSE...

Range Rover Sport offers an exclusive range of options that allow you to personalise your vehicle. The following pages take you through a logical series of steps to make it a true expression of your individuality. You have several choices: from selecting your engine and model to exterior and interior colours, wheels, finishes and those detailed touches that define your style.

If you'd like to bring your options to life, go to our online configurator at [landrover.com](http://landrover.com)

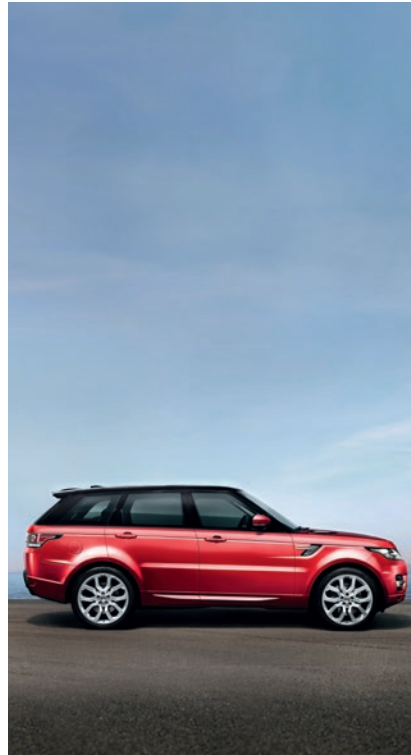

## Hybrid

Page 22

The world's first Diesel Hybrid SUV.

## Step 1

### Choose your engine

Page 26

You can select from a powerful range of petrol or diesel engines including the new hybrid diesel engine.

## Step 2

### Choose your model

Page 28

Compare the standard features on each model.

## Step 3

### Choose your colour

Page 32

There's a wide range on offer to enable you to express yourself.

## Step 4

### Choose your wheels

Page 36

There's a range of styles, each one designed to complement the bold exterior.



## Step 5

### Choose your interior

Page 38

Carefully selected colours complemented by the finest metals and real wood veneers. You can personalise your own interior space.

### Key Features

Page 58

The latest innovations that make your vehicle a pleasure to drive.

### Technical Details

Page 62

Technical information and data for dimensions, performance and specifications.

### Accessories

Page 64

Additional accessories can enhance your personal requirements.

## RANGE ROVER SPORT HYBRID

Range Rover Sport Hybrid is the first diesel SUV of its kind in the world. It has been designed and engineered to deliver class-leading capability and versatility. By fully integrating the hybrid technologies into the chassis, nothing has been lost in ground clearance, approach and departure angles or the 850mm wading depth.

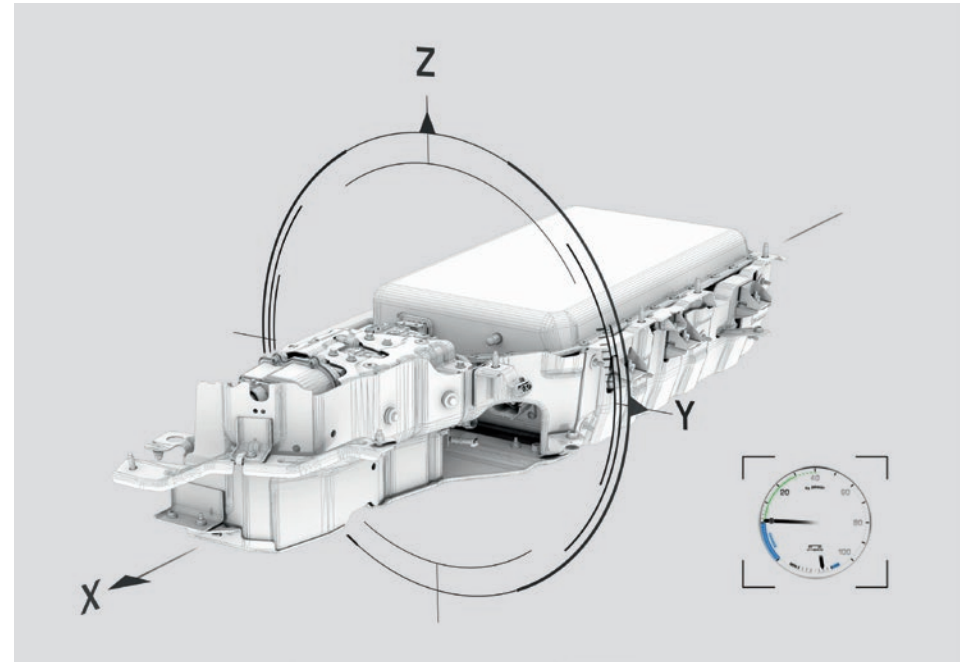

Range Rover Sport Hybrid has been tested on the most demanding terrains, rigs and under the same extremes as every Land Rover. Whilst nothing has been lost in the responsiveness of the drive, hybrid technologies deliver impressive efficiencies. The 3.0L LR-SDV6 Diesel engine with a 35kW electric motor generates an impressive 700Nm of torque resulting in the same performance as the LR-SDV8 Diesel but with 13% lower (25g/km less) CO<sub>2</sub> emissions when compared to the LR-TDV6 engine at 169g/km.



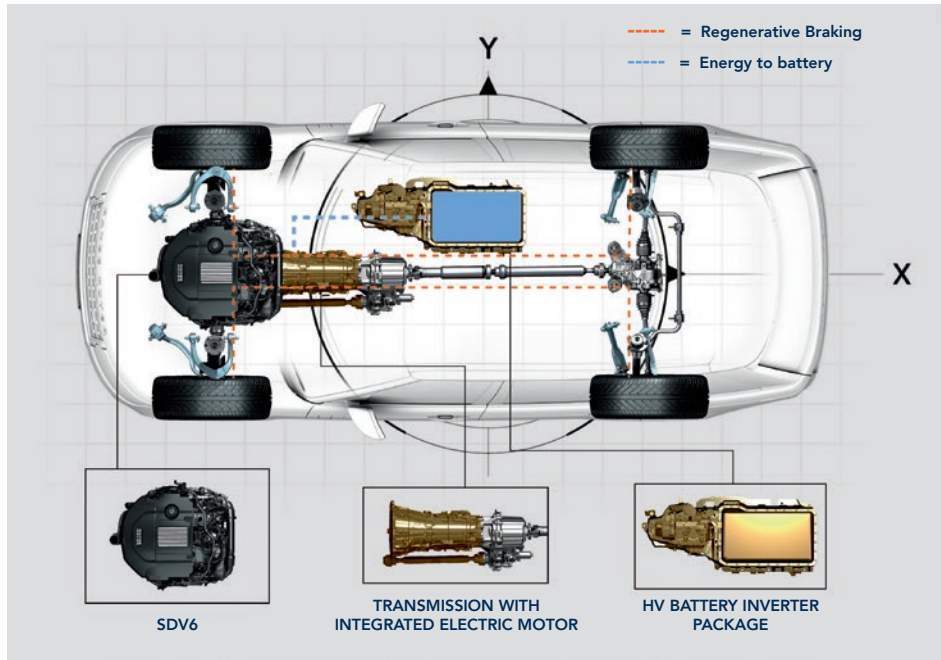

Innovative engineering ensures the transmission of energy between battery and engine is seamless. This energy is created by the Regenerative Braking process, which captures and stores kinetic energy in the battery, normally lost through braking. This is then used to power the electric motor and ensures that torque is instantly available on demand so the vehicle maintains unrivalled breadth of capability.

## RANGE ROVER SPORT HYBRID

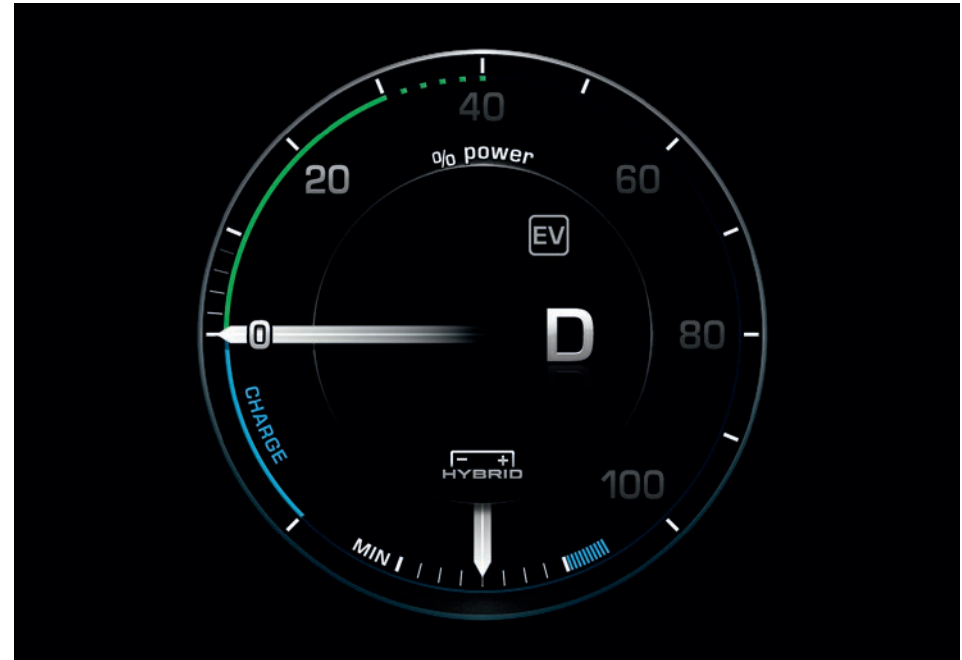

Select from four Hybrid driving modes to tailor the vehicle's performance to your requirements giving the most dynamic model in Land Rover portfolio an extra dimension.

- EV** Electric Vehicle (EV) On Mode: Optimises hybrid battery power and is whisper quiet whilst travelling around town or peaceful villages.
- EV** EV Off Mode: Enables the vehicle's default setting where the hybrid system selects the most efficient combination of diesel and electric power to meet the power and torque required.
- S** Sport Mode: Gives full access to the vehicle's comparable LR-SDV8 performance. The throttle response becomes more immediate with torque triggered from less pedal pressure, ideal for overtaking when it is safe to do so.
- A OFF** Auto Stop/Start: Increases charging opportunities as this option means the engine runs continuously, inhibiting the Stop/Start system.



Attention to detail is at the very heart of Land Rover. That's why even the alloy wheels on Range Rover Sport Hybrid have been designed for increased efficiency. The design features spokes that are aerodynamically shaped so, as they move through the air, they require less power to keep them moving.

To finish, the vehicle is specified with a unique Hybrid badge that is located on the side vent.

STEP 1 CHOOSE YOUR ENGINE



## DRIVELINE, ENGINE PERFORMANCE AND FUEL ECONOMY

The improved range of petrol and diesel engines, along with the new hybrid engine, use the very latest technology. In fact, coupled with lightweight all-aluminium technology and an eight-speed transmission, these engines deliver greatly improved fuel efficiency and lower CO<sub>2</sub> emissions. However, nothing has been lost in performance. For instance, the 5.0 litre LR-V8 Supercharged goes from 0-100kph in just 5.3 seconds. The 3.0 litre LR-TDV6 diesel features intelligent Stop/Start technology (market dependent) that automatically shuts down the engine at rest and starts again as soon as you lift your foot off the brake.

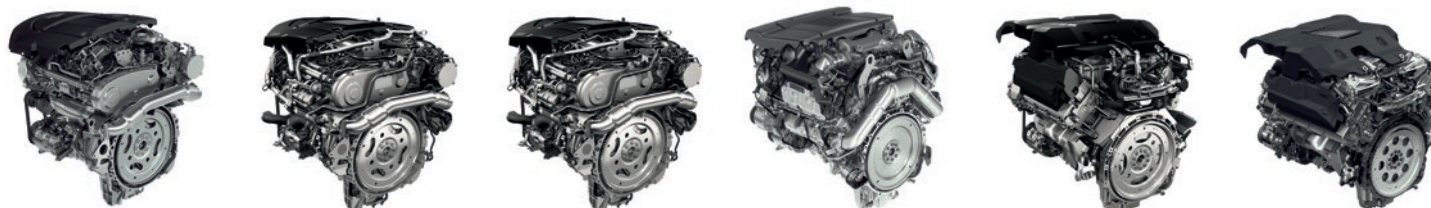

		<b>3.0L TDV6 DIESEL</b>	<b>3.0L SDV6 DIESEL</b>	<b>3.0L SDV6 HYBRID DIESEL*</b>	<b>4.4L SDV8 DIESEL</b>	<b>3.0L V6 PETROL</b>	<b>5.0L V8 SUPERCHARGED PETROL</b>
Driveline		Four Wheel Drive (4WD)	Four Wheel Drive (4WD)	Four Wheel Drive (4WD)	Four Wheel Drive (4WD)	Four Wheel Drive (4WD)	Four Wheel Drive (4WD)
Power (kW/PS)		190 / 258	215 / 292	250 / 340**	250 / 339	250 / 340	375 / 510
Torque (Nm)		600	600	700**	740	450	625
Maximum torque (rpm)		2,000	2,000	1,500 – 3,000**	1,750 – 3,000	3,500 – 5,000	2,500 – 5,500
Capacity (cc)		2,993	2,993	2,993	4,367	2,995	4,999.7
No. of cylinders		6	6	6	8	6	8
Cylinder layout		Longitudinal V6	Longitudinal V6	Longitudinal V6	Longitudinal V8	Longitudinal V6	Longitudinal V8
<b>FUEL ECONOMY</b>							
Urban	l/100km (mpg)	8.3 (34.0) / 9.8 (28.8) <sup>†</sup>	8.7 (32.5) / 9.8 (28.8) <sup>†</sup>	6.7 (42.0)	11.5 (24.6)	14.0 (20.2) / 15.4 (18.3) <sup>†</sup>	18.3 (15.4) / 20.5 (13.8) <sup>†</sup>
Extra Urban	l/100km (mpg)	6.7 (42.2) / 6.8 (41.5) <sup>†</sup>	6.8 (41.5) / 6.8 (41.5) <sup>†</sup>	6.3 (45.0)	7.6 (37.2)	8.8 (32.1) / 8.9 (31.7) <sup>†</sup>	9.7 (29.1) / 10.0 (28.3) <sup>†</sup>
Combined	l/100km (mpg)	7.3 (38.7) / 7.9 (35.8) <sup>†</sup>	7.5 (37.7) / 7.5 (35.8) <sup>†</sup>	6.4 (44.1)	8.7 (32.5)	10.7 (26.4) / 11.3 (25.0) <sup>†</sup>	12.8 (22.1) / 13.8 (20.5) <sup>†</sup>
CO <sub>2</sub> Urban emissions	g/km	218 / 258 <sup>†</sup>	230 / 258 <sup>†</sup>	177	306	326 / 359 <sup>†</sup>	426 / 478 <sup>†</sup>
CO <sub>2</sub> Extra Urban emissions	g/km	177 / 180 <sup>†</sup>	180 / 180 <sup>†</sup>	165	203	205 / 208 <sup>†</sup>	226 / 233 <sup>†</sup>
CO <sub>2</sub> Combined emissions	g/km	194 / 209 <sup>†</sup>	199 / 209 <sup>†</sup>	169	229	249 / 264 <sup>†</sup>	298 / 321 <sup>†</sup>

\*Not available in all markets \*\*When combined with electric motor. <sup>†</sup>Without Intelligent Stop/Start technology.

Fuel consumption figures: the results given here do not express or imply any guarantee of the fuel consumption of any particular vehicle with which this information may be supplied. Vehicles are not individually tested and there are inevitable differences between individual vehicles of the same model. The vehicle may also incorporate particular modifications. Furthermore, the driver's style and road traffic conditions, as well as the extent to which the vehicle has been driven and the standard of maintenance, will affect its fuel consumption. Low fuel warning at 9 litres approximately.

Vehicle shown left is Autobiography in Firenze Red.

Visit [landrover.com](http://landrover.com) for more information.

STEP 2 CHOOSE YOUR MODEL



# MODELS BY ENGINE

	S	SE	HSE	HSE WITH DYNAMIC PACK	AUTOBIOGRAPHY	AUTOBIOGRAPHY WITH DYNAMIC PACK
3.0L TDV6 Diesel	■	■	■			
3.0L SDV6 Diesel	■	■	■	■	■	■
3.0L SDV6 Hybrid Diesel*			■	■	■	■
4.4L SDV8 Diesel			■	■	■	■
3.0L V6 Petrol	■	■	■	■	■	■
5.0L V8 Supercharged Petrol			■	■	■	■

\*Not available in all markets.

Vehicle shown left is Autobiography in Firenze Red.

Visit [landrover.com](http://landrover.com) for more information.

## STEP 2 CHOOSE YOUR MODEL – CHOICES

Each model has a choice of engines and unique features. This guide will help you to select your ideal Range Rover Sport. On the following pages you'll see the standard features for each model.

### RANGE ROVER SPORT S / SE\*



- Grille in Dark Atlas with Gloss Black surround
- Fender vent with Dark Atlas fingers, Atlas mesh and Gloss Black surround
- Body coloured upper mirror caps
- Tow eye covers in Dark Atlas
- 19 inch five split-spoke 'Style 501' (TDV6 only)
- 20 inch five split-spoke 'Style 520' (Standard on SE with SDV6)
- Seats for S model in Cloth
- Seats for SE model in Grained leather.

### RANGE ROVER SPORT HSE



- Grille in Atlas with Gloss Black surround
- Fender vent with Atlas fingers, Atlas mesh and Gloss Black surround
- Body coloured upper mirror caps
- Fog lamp surrounds and tow eye covers in Atlas
- 20 inch five split-spoke 'Style 520'
- Seats in Oxford Perforated leather as standard
- Available with Hybrid.



## RANGE ROVER SPORT HSE WITH DYNAMIC PACK



- Grille in Gloss Black painted mesh with Gloss Black surround
- Fender vent with Gloss Black fingers, Atlas mesh and Gloss Black surround
- Gloss Black upper mirror caps
- Fog lamp surrounds and tow eye covers in Gloss Black
- Tailgate finisher in Gloss Black
- 21 inch five split-spoke 'Style 507' with Diamond Turned finish
- 20 inch Red Brembo™ branded brake calipers
- Performance Enhancement (increase in Top Speed)
- Seats in Oxford Perforated leather as standard
- Additional Dynamic pack interior colourways
- Available with Hybrid.

## RANGE ROVER SPORT AUTOBIOGRAPHY



- Grille in Atlas with Gloss Black surround
- Fender vent with Atlas fingers, Atlas mesh and Gloss Black surround
- Body coloured upper mirror caps
- Body coloured side sills and lower bumper corners
- Fog lamp surrounds and tow eye covers in Atlas
- 21 inch five split-spoke 'Style 507'
- Seats in Oxford Perforated leather with Autobiography Pattern as standard
- Available with Hybrid.

## RANGE ROVER SPORT AUTOBIOGRAPHY WITH DYNAMIC PACK



- Grille in Gloss Black painted mesh with Gloss Black surround
- Fender vent with Gloss Black fingers, Atlas mesh and Gloss Black surround
- Gloss Black upper mirror caps
- Unique design of front and rear bumper corners in body colour
- Body coloured side sills
- Fog lamp surrounds and tow eye covers in Gloss Black
- Tailgate finisher in Gloss Black
- 21 inch five split-spoke 'Style 505'
- 20 inch Red Brembo™ branded brake calipers
- Performance Enhancement (increase in Top Speed)
- Seats in Oxford Perforated leather with Autobiography Pattern as standard
- Additional Dynamic pack interior colourways
- Available with Hybrid.

# STEP 3 CHOOSE YOUR COLOUR

## Body and Roof Colour



## Optional Roof Colour

### Contrast Indus Silver



### Contrast Corris Grey



### Contrast Santorini Black



\*The availability of exterior paint colours varies by model and by time of year.  
Please contact your nearest Land Rover Dealer for further details.

### Body and Roof Colour

Firenze Red (Metallic)    Chile\* (Premium Metallic)    Aintree Green (Metallic)    Loire Blue (Metallic)    Mariana Black (Premium Metallic)    Santorini Black (Metallic)    Barossa\* (Premium Metallic)    Havana (Premium Metallic)    Barolo Black (Premium Metallic)



### Optional Roof Colour

Contrast Indus Silver



Contrast Corris Grey



Contrast Santorini Black



Visit [landrover.com](http://landrover.com) for more information.

STEP 3 CHOOSE YOUR COLOUR – STEALTH PACK



### Personalising the exterior

For an even more striking effect, Range Rover Sport HSE with Dynamic Pack and Autobiography with Dynamic Pack can be further personalised with the optional Stealth Pack. Emphasising the assertive, confident stance of the vehicle, the Stealth Pack makes Range Rover Sport your own.



Stealth Pack is available in all exterior colour options and includes Satin Black exterior accents such as; front grille and grille surround, RANGE ROVER lettering on bonnet and tailgate, upper mirror caps, tow eye cover. In addition the pack comes with darkened front and rear headlamps and a choice of 21 inch or 22 inch wheels in Satin Black finish.

## STEP 4 CHOOSE YOUR WHEELS



19 INCH FIVE SPLIT-SPOKE  
'STYLE 501'\*



19 INCH FIVE SPLIT-SPOKE  
SATIN DARK GREY FINISH  
'STYLE 501'\*



20 INCH FIVE SPLIT-SPOKE  
'STYLE 520'\*



21 INCH FIVE SPLIT-SPOKE  
'STYLE 507'\*



21 INCH FIVE SPLIT-SPOKE  
DIAMOND TURNED FINISH  
'STYLE 507'\*



21 INCH FIVE SPLIT-SPOKE  
'STYLE 505'



21 INCH SIX-SPOKE  
DIAMOND TURNED FINISH  
'STYLE 602'  
(HYBRID ONLY)



21 INCH SIX-SPOKE  
'STYLE 602'  
(HYBRID ONLY)



21 INCH NINE SPOKE  
SATIN BLACK FINISH  
'STYLE 901'  
(STEALTH PACK ONLY)



22 INCH FIVE SPLIT-SPOKE  
'STYLE 504'



22 INCH FIVE SPLIT-SPOKE  
'STYLE 508'



22 INCH FIVE SPLIT-SPOKE  
SATIN BLACK FINISH  
'STYLE 508'  
(STEALTH PACK ONLY)

## STEP 5 CHOOSE YOUR INTERIOR





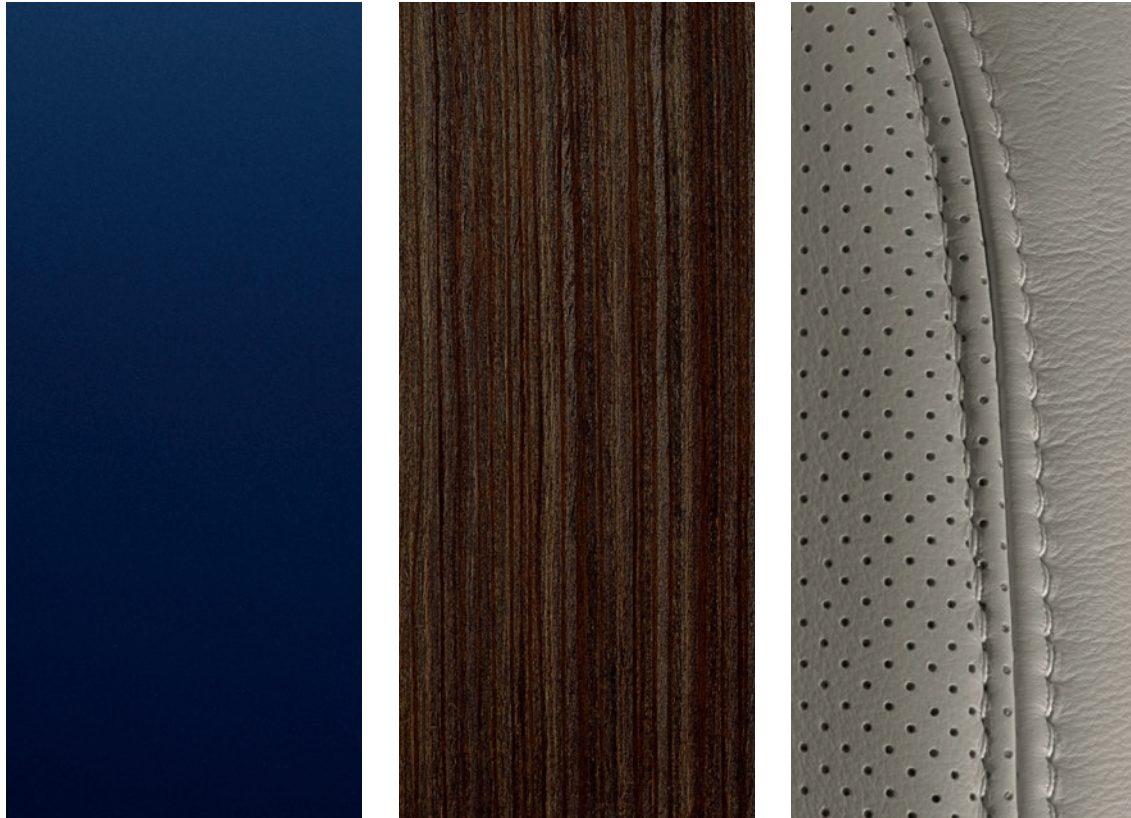

Contemporary. Beautifully designed. Flawlessly executed. The interior of each and every Range Rover Sport defines modern living. The strong architectural lines of the interior are balanced by soft lighting and the choice of colourways available. The fit and finish has been taken to another level: the use of leather and metal truly complements the sporty styling.

## STEP 5 CHOOSE YOUR INTERIOR – LEATHER FINISHES



### **The softest of leathers, the most meticulous of finishes**

The interior is upholstered in the finest natural materials. The warmth of wood veneers, superb metal finishes and soft leathers combine to create a sense of home. The attention to detail is everywhere you look and in everything you touch. The type of leather is determined by model choice as outlined in the following pages.

## STEP 5 CHOOSE YOUR INTERIOR – TRIM FINISHER CHOICES



DARK BRUSHED  
ALUMINIUM FINISHER

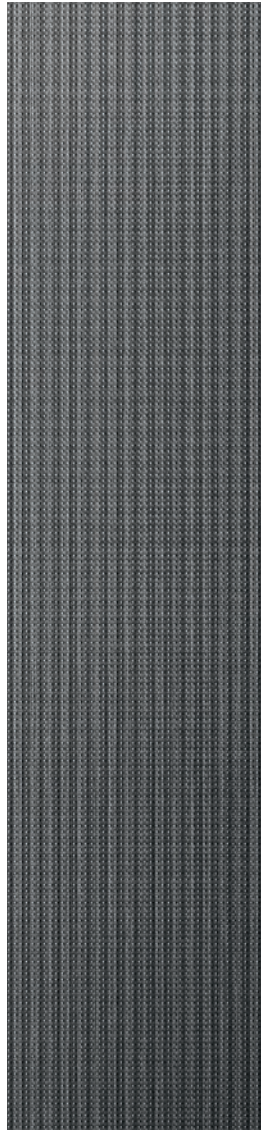

MICRO MESH  
ALUMINIUM FINISHER

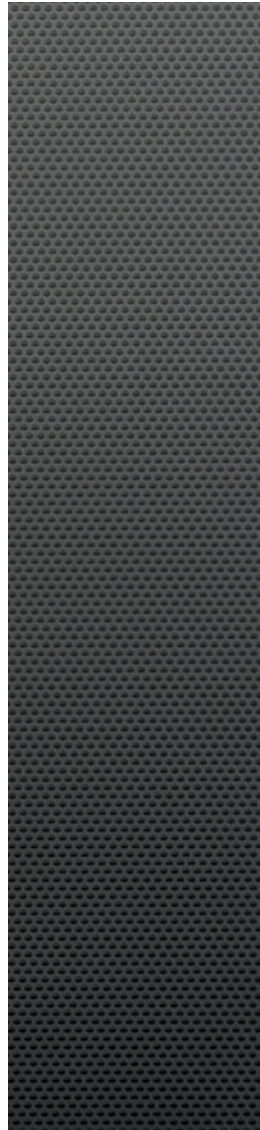

SPORT TEXTURED  
ALUMINIUM FINISHER



DARK ENGINE TURNED  
ALUMINIUM FINISHER



SHADOW ZEBRANO  
WOOD VENEER



DARK GREY OAK  
WOOD VENEER

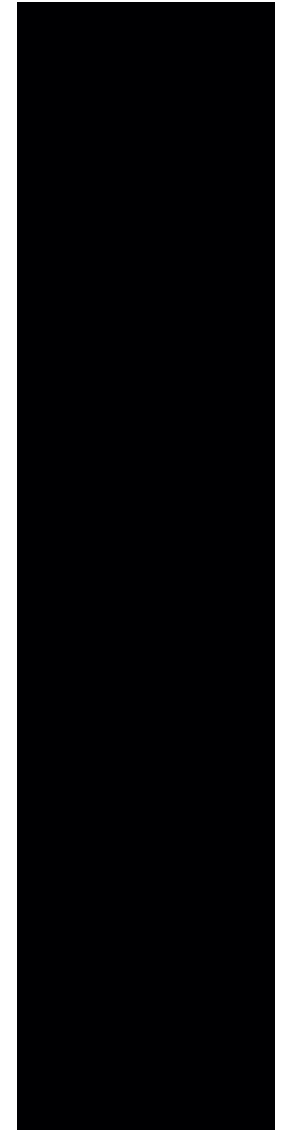

GRAND BLACK  
WOOD VENEER

## STEP 5 CHOOSE YOUR INTERIOR – INTERIOR SEAT OPTIONS



### 5 Seats

The seat configuration has been intelligently redesigned to accommodate the lines of the roofline. It's light and spacious, ensuring everyone has a relaxed and comfortable journey. There is generous leg, shoulder and head room throughout the contemporary cabin.





























### 5+2 Seating



























The 5+2 arrangement has two seats stowed under the floor of the luggage compartment that have been designed for occasional use, enabling the vehicle to accommodate up to seven occupants.\*

\*The third row seats are not suitable for use by children who require child seats or booster seats.

# COLOUR AND TRIM MATRIX

COLOURWAYS		EBONY/LUNAR (page 47)			ESPRESSO/ALMOND (page 48)			EBONY/CIRRUS (page 49)			ESPRESSO/IVORY (page 50)		
<b>INTERIOR COLOUR</b>													
Seat colour		Ebony	Lunar	Ebony/ Lunar	Espresso	Almond	Espresso/ Almond	Ebony	Cirrus	Ebony/ Cirrus	Espresso	Ivory	Espresso/ Ivory
Carpet		Ebony			Espresso			Ebony			Espresso		
<b>MODEL</b>													
S (Cloth)		○	–	–	–	–	–	–	–	–	–	–	–
SE (Grained leather)		○	–	–	–	○	–	–	○	–	–	–	–
HSE (Oxford Perforated leather)		○	○	–	○	○	–	○	○	–	○	○	–
HSE with Dynamic Pack (Oxford Perforated leather)		○	○	–	○	○	–	○	○	–	○	○	–
Autobiography (Oxford Perforated leather with Autobiography Pattern)		○	○	○	○	○	○	○	○	○	○	○	○
Autobiography with Dynamic Pack (Oxford Perforated leather with Autobiography Pattern)		○	○	○	○	○	○	○	○	○	○	○	○
<b>TRIM FINISHER</b>													
 Dark Brushed Aluminium finisher		○	–	–	–	○	–	–	○	–	–	–	–
 Micro Mesh Aluminium finisher		○	–	–	○	○	–	○	○	–	○	○	–
 Sport Textured Aluminium finisher		○	○	–	○	○	–	○	○	–	○	○	–
 Dark Engine Turned Aluminium finisher		○	○	○	○	○	○	○	○	○	○	○	○
 Shadow Zebrano Wood Veneer		–	–	–	○	○	○	–	–	–	○	○	○
 Dark Grey Oak Wood Veneer		○	○	○	–	–	–	○	○	○	–	–	–
 Grand Black Wood Veneer		○	○	○	○	○	○	○	○	○	○	○	○
<b>EXTERIOR COLOUR</b>													
 Fuji White		○	○	○	○	○	○	○	○	▲	○	○	○
 Yulong White*		○	○	▲	○	○	○	▲	▲	▲	○	○	○
 Aleutian Silver		○	○	○	○	○	○	○	▲	○	○	○	○
 Indus Silver		▲	○	○	○	○	○	▲	○	○	○	○	○
 Kaikoura Stone		○	○	○	▲	○	○	○	○	○	▲	○	▲
 Aruba		○	○	○	▲	○	○	○	○	○	▲	○	○
 Chablis		○	○	○	○	○	○	○	○	○	○	○	○
 Scotia Grey		○	○	○	○	○	○	○	○	○	○	○	○
 Corris Grey		○	○	▲	○	○	○	○	○	○	○	○	○
 Causeway Grey		○	○	▲	○	○	○	▲	○	▲	○	○	○
 Montalcino Red		○	○	○	○	○	○	○	○	○	○	○	○
 Firenze Red		○	○	○	○	○	○	○	○	○	○	○	○
 Chile*		▲	○	○	○	○	○	▲	○	○	○	○	○
 Aintree Green		○	○	○	○	○	○	○	○	○	○	▲	○
 Loire Blue		○	○	○	○	○	○	○	○	○	○	○	○
 Mariana Black		○	○	○	○	○	○	○	▲	○	○	○	○
 Barossa*		○	○	○	○	▲	○	○	○	○	○	○	○
 Santorini Black		○	▲	○	○	○	○	○	▲	○	○	○	○
 Havana		○	▲	○	○	○	▲	○	○	○	○	○	▲
 Barolo Black		○	○	○	○	○	○	○	○	○	○	▲	○

\*The availability of exterior paint colours varies by model and by time of year. Please contact your nearest Land Rover Dealer for further details.  
 ▲ Combination is Designer's Choice ○ Combination is Available – Not Available.

COLOURWAYS	EBONY/IVORY (page 51)			EBONY/TAN (page 52)		EBONY/PIMENTO (page 53)		ESPRESSO/ IVORY/TAN (page 54)	ESPRESSO/IVORY/ SAVANNAH (page 55)	EBONY/LUNAR/ CIRRUS (page 56)	EBONY/LUNAR/ SAVANNAH (page 57)
<b>INTERIOR COLOUR</b>											
Seat colour	Ebony	Ivory	Ebony/ Ivory	Tan	Ebony/ Tan	Pimento	Ebony/ Pimento	Espresso/Ivory/ Tan	Espresso/Ivory/ Savannah	Ebony/Lunar/ Cirrus	Ebony/Lunar/ Savannah
Carpet	Ebony			Ebony		Ebony		Espresso	Espresso	Ebony	Ebony
<b>MODEL</b>											
S (Cloth)	-	-	-	-	-	-	-	-	-	-	-
SE (Grained leather)	-	-	-	-	-	-	-	-	-	-	-
HSE (Oxford Perforated leather)	o	o	-	-	-	-	-	-	-	-	-
HSE with Dynamic Pack (Oxford Perforated leather)	o	o	-	o	-	o	-	-	-	-	-
Autobiography (Oxford Perforated leather with Autobiography Pattern)	o	o	o	-	-	-	-	o	o	-	-
Autobiography with Dynamic Pack (Oxford Perforated leather with Autobiography Pattern)	o	o	o	o	o	o	o	o	o	o	o
<b>TRIM FINISHER</b>											
 Dark Brushed Aluminium finisher	-	-	-	-	-	-	-	-	-	-	-
 Micro Mesh Aluminium finisher	o	o	-	-	-	-	-	-	-	-	-
 Sport Textured Aluminium finisher	o	o	-	o	-	o	-	-	-	-	-
 Dark Engine Turned Aluminium finisher	o	o	o	o	o	o	o	o	o	o	o
 Shadow Zebrano Wood Veneer	o	o	o	-	-	-	-	o	o	-	-
 Dark Grey Oak Wood Veneer	-	-	-	o	o	o	o	-	-	o	o
 Grand Black Wood Veneer	o	o	o	o	o	o	o	o	o	o	o
<b>EXTERIOR COLOUR</b>											
 Fuji White	o	o	o	▲	o	o	o	▲	o	▲	o
 Yulong White*	o	o	o	▲	▲	▲	o	o	o	o	▲
 Aleutian Silver	o	o	o	o	o	o	o	o	o	▲	o
 Indus Silver	o	o	o	o	o	o	o	o	o	o	o
 Kaikoura Stone	o	o	o	o	o	o	o	o	▲	o	o
 Aruba	o	▲	o	o	o	o	▲	▲	▲	o	o
 Chablis	o	o	o	o	o	o	o	o	▲	▲	▲
 Scotia Grey	o	o	o	o	o	o	o	o	o	o	o
 Corris Grey	o	o	o	▲	o	o	▲	o	o	▲	▲
 Causeway Grey	o	o	▲	o	▲	▲	o	o	o	▲	▲
 Montalcino Red	o	o	o	-	-	o	▲	-	o	o	-
 Firenze Red	▲	o	o	-	-	o	▲	o	-	o	-
 Chile*	o	o	o	o	o	o	o	o	-	o	-
 Aintree Green	o	o	o	o	o	o	o	o	o	o	o
 Loire Blue	o	▲	o	o	o	o	o	o	o	o	o
 Mariana Black	o	▲	o	o	o	o	o	o	o	o	o
 Santorini Black	o	▲	▲	o	▲	▲	o	o	o	o	▲
 Barossa*	o	o	o	o	o	o	o	-	-	-	-
 Havana	▲	o	o	▲	o	o	o	o	▲	o	o
 Barolo Black	o	o	o	o	o	o	▲	o	o	o	o

\*The availability of exterior paint colours varies by model and by time of year. Please contact your nearest Land Rover Dealer for further details.

▲ Combination is Designer's Choice o Combination is Available - Not Available.

The above table is designed as a guide. Please contact your nearest Land Rover Dealer for more information.

## STEP 5 CHOOSE YOUR INTERIOR – CHOICES

### Colour choices

Each interior comes in up to three colour combinations. You can now use this section to place your chosen colourway within the vehicle to personalise your cabin. A choice of trim finishers are also available.



COLOURWAYS	① INSTRUMENT PANEL UPPER	② INSTRUMENT PANEL MID/ CENTRE CUBBY LID	③ DOOR TOP ROLL	④ DOOR ARMREST	⑤ DOOR LOWER
Ebony/Lunar	Ebony	Lunar	Lunar	Lunar	Ebony
Espresso/Almond	Espresso	Almond	Almond	Almond	Almond
Ebony/Cirrus	Ebony	Cirrus	Cirrus	Cirrus	Ebony
Espresso/Ivory	Espresso	Ivory	Ivory	Ivory	Ivory
Ebony/Ivory	Ebony	Ivory	Ivory	Ivory	Ebony
Ebony/Tan	Ebony	Tan	Tan	Tan	Ebony
Ebony/Pimento	Ebony	Pimento	Pimento	Pimento	Ebony
Espresso/Ivory/Tan	Espresso	Ivory	Ivory	Tan	Ivory
Espresso/Ivory/Savannah	Espresso	Ivory	Ivory	Savannah	Ivory
Ebony/Lunar/Cirrus	Ebony	Lunar	Lunar	Cirrus	Ebony
Ebony/Lunar/Savannah	Ebony	Lunar	Lunar	Savannah	Ebony



**Ebony / Lunar** (available on S, SE, HSE, HSE with Dynamic Pack, Autobiography and Autobiography with Dynamic Pack)



Interior Shown:  
HSE interior in Ebony/Lunar,  
with Ebony seats and Dark Brushed  
Aluminium finisher.

**Seat Choices**



Ebony



Lunar



Ebony/Lunar

**Trim Finisher Choices**



Dark Brushed Aluminium finisher

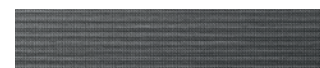

Micro Mesh Aluminium finisher



Sport Textured Aluminium finisher



Dark Engine Turned Aluminium finisher



Grand Black Wood Veneer



Dark Grey Oak Wood Veneer

This interior is available in:  
Cloth on S models  
Grained leather on SE models  
Oxford leather on HSE models  
Oxford leather with Autobiography Pattern  
on Autobiography models.

For specific colourway options please refer to page 44.

## STEP 5 CHOOSE YOUR INTERIOR – CHOICES

**Espresso / Almond** (available on SE, HSE, HSE with Dynamic Pack, Autobiography and Autobiography with Dynamic Pack)



Interior shown:  
Autobiography interior in  
Espresso/Almond, with Espresso/  
Almond seats and Shadow  
Zebrano Wood Veneer.

### Seat Choices



Espresso



Almond



Espresso/Almond

### Trim Finisher Choices



Dark Brushed Aluminium finisher



Micro Mesh Aluminium finisher



Sport Textured Aluminium finisher



Dark Engine Turned Aluminium finisher



Grand Black Wood Veneer



Shadow Zebrano Wood Veneer

This interior is available in:  
Grained leather on SE models  
Oxford leather on HSE models  
Oxford leather with Autobiography Pattern  
on Autobiography models.

For specific colourway options please refer to page 44.

**Ebony / Cirrus** (available on SE, HSE, HSE with Dynamic Pack, Autobiography and Autobiography with Dynamic Pack)

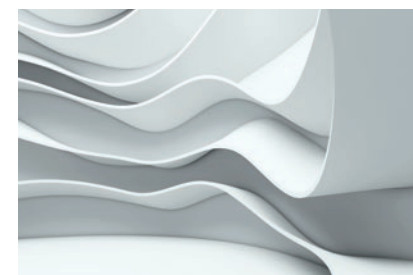

Interior shown:  
HSE interior in Ebony/Cirrus,  
with Ebony seats and  
Grand Black Wood Veneer.

**Seat Choices**



Ebony



Cirrus



Ebony/Cirrus

**Trim Finisher Choices**



Dark Brushed Aluminium finisher

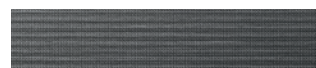

Micro Mesh Aluminium finisher



Sport Textured Aluminium finisher



Dark Engine Turned Aluminium finisher



Grand Black Wood Veneer



Dark Grey Oak Wood Veneer

This interior is available in:  
Grained leather on SE models  
Oxford leather on HSE models  
Oxford leather with Autobiography Pattern  
on Autobiography models.

For specific colourway options please refer to pages 44.

## STEP 5 CHOOSE YOUR INTERIOR – CHOICES

**Espresso / Ivory** (available on HSE, HSE with Dynamic Pack, Autobiography and Autobiography with Dynamic Pack)



Interior shown:  
Autobiography interior in  
Espresso/Ivory, with Espresso/  
Ivory seats and Micro Mesh  
Aluminium finisher.

### Seat Choices



Espresso

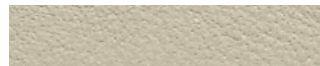

Ivory



Espresso/Ivory

### Trim Finisher Choices



Micro Mesh Aluminium finisher



Sport Textured Aluminium finisher



Dark Engine Turned Aluminium finisher



Grand Black Wood Veneer



Shadow Zebrano Wood Veneer

This interior is available in:  
Oxford leather on HSE models  
Oxford leather with Autobiography Pattern  
on Autobiography models.

For specific colourway options please refer to page 44.

**Ebony / Ivory** (HSE, HSE with Dynamic Pack, Autobiography and Autobiography with Dynamic Pack)



Interior shown:  
Autobiography interior in  
Ebony/Ivory, with Ebony/Ivory  
seats and Micro Mesh  
Aluminium finisher.

**Seat Choices**



Ebony



Ivory



Ebony/Ivory

**Trim Finisher Choices**



Micro Mesh Aluminium finisher



Sport Textured Aluminium finisher



Dark Engine Turned Aluminium finisher



Grand Black Wood Veneer



Shadow Zebrano Wood Veneer

This interior is available in:  
Oxford leather on HSE models  
Oxford leather with Autobiography Pattern  
on Autobiography models.  
For specific colourway options please refer to page 45.

## STEP 5 CHOOSE YOUR INTERIOR – CHOICES

**Ebony / Tan** (available on HSE with Dynamic Pack and Autobiography with Dynamic Pack)



Interior shown:  
Autobiography with Dynamic Pack  
interior in Ebony/Tan, with  
Ebony/Tan seats and Dark Grey  
Oak Wood Veneer.

### Seat Choices



Tan



Ebony/Tan\*

### Trim Finisher Choices



Sport Textured Aluminium finisher



Dark Engine Turned Aluminium finisher



Dark Grey Oak Wood Veneer



Grand Black Wood Veneer

This interior is available in:  
Oxford leather on HSE models  
Oxford leather with Autobiography Pattern  
on Autobiography models.

For specific colourway options please refer to pages 45.

**Ebony / Pimento** (available on HSE with Dynamic Pack and Autobiography with Dynamic Pack)



Interior shown:  
Autobiography with Dynamic Pack  
interior in Ebony/Pimento, with  
Ebony/Pimento seats and Dark  
Engine Turned Aluminium finisher.

**Seat Choices**



Pimento



Ebony/Pimento\*

**Trim Finisher Choices**



Sport Textured Aluminium finisher



Dark Engine Turned Aluminium finisher



Dark Grey Oak Wood Veneer



Grand Black Wood Veneer

This interior is available in:  
Oxford leather on HSE models  
Oxford leather with Autobiography pattern  
on Autobiography models.

For specific colourway options please refer to pages 45.

\*Only available on Autobiography with Dynamic Pack models.

## STEP 5 CHOOSE YOUR INTERIOR – CHOICES

**Espresso / Ivory / Tan** (available on Autobiography and Autobiography with Dynamic Pack only)



Interior shown:  
Autobiography interior in  
Espresso/Ivory/Tan, with Espresso/  
Ivory/Tan seats and Shadow  
Zebrano Wood Veneer.

### Seat Choices



Espresso/Ivory/Tan

### Trim Finisher Choices



Dark Engine Turned Aluminium finisher



Shadow Zebrano Wood Veneer



Grand Black Wood Veneer

This interior is available in:  
Oxford leather with Autobiography Pattern  
on Autobiography models.

For specific colourways please refer to page 45.



**Espresso / Ivory / Savannah** (available on Autobiography and Autobiography with Dynamic Pack only)



Interior shown:  
Autobiography interior in Espresso/Ivory/Savannah, with Espresso/Ivory/Savannah seats and Dark Engine Turned Aluminium finisher.

**Seat Choices**



Espresso/Ivory/Savannah

**Trim Finisher Choices**



Dark Engine Turned Aluminium finisher



Grand Black Wood Veneer



Shadow Zebrano Wood Veneer

This interior is available in:  
Oxford leather with Autobiography Pattern  
on Autobiography models.  
For specific colourways please refer to page 45.

## STEP 5 CHOOSE YOUR INTERIOR – CHOICES

**Ebony / Lunar / Cirrus** (available on Autobiography with Dynamic Pack only)



Interior shown:  
Autobiography with Dynamic Pack  
interior in Ebony/Lunar/Cirrus,  
with Ebony/Lunar/Cirrus seats  
and Dark Grey Oak Wood Veneer.

### Seat Choices



Ebony/Lunar/Cirrus

### Trim Finisher Choices

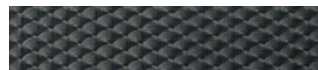

Dark Engine Turned Aluminium finisher



Dark Grey Oak Wood Veneer



Grand Black Wood Veneer

This interior is available in:  
Oxford leather with Autobiography Pattern  
on Autobiography models.

For specific colourways please refer to page 45.

**Ebony / Lunar / Savannah** (available on Autobiography with Dynamic Pack only)



Interior shown:  
Autobiography with Dynamic Pack  
interior in Ebony/Lunar/Savannah,  
with Ebony/Lunar/Savannah seats  
and Dark Grey Oak Wood Veneer.

**Seat Choices**



Ebony/Lunar/Savannah

**Trim Finisher Choices**



Dark Engine Turned Aluminium finisher



Grand Black Wood Veneer



Dark Grey Oak Wood Veneer

This interior is available in:  
Oxford leather with Autobiography Pattern  
on Autobiography models.

For specific colourways please refer to page 45.

## KEY FEATURES





#### Terrain Response® 2

Next generation Terrain Response® 2 is designed to monitor driving conditions and automatically optimises the vehicle's settings to suit the terrain. This gives you the ultimate in ride comfort on all surfaces including grass/gravel/snow, mud/ruts, sand and rock. And even if it is not in auto mode, it will let you know if you should select low range and off-road ride height.



#### Eight-speed Automatic Transmission with CommandShift® 2

All petrol and diesel engines in Range Rover Sport are paired with the advanced electronically controlled eight-speed automatic gearbox which has been tuned by Land Rover engineers to combine silky smooth shifting with exceptionally rapid responses and outstanding fuel economy. With eight closely-spaced ratios, gear changes are almost imperceptible, with each shift completed in just 200 milliseconds.



#### Electric Power Assisted Steering (EPAS)

The Electric Power Assisted Steering (EPAS) system helps to deliver accurate, consistent steering and agile cornering. Power assistance is speed-sensitive so the steering is light and responsive at lower speeds and firmer at higher speeds.



#### Dynamic Response

Dynamic Response transforms vehicle handling through hydraulic roll and yaw control, optimising on road performance and passenger comfort. The system works in addition to Adaptive Dynamics which monitors the vehicle's movements over 500 times a second, reacting to driver or road inputs virtually instantaneously, helping to give greater control and minimising body roll, for a composed ride.



#### Electronic Air Suspension

Range Rover Sport features a next-generation four corner air suspension system which delivers class-leading comfort and capabilities both on and off-road. The air suspension system automatically switches between two ride heights when the off-road setting is selected. Maximum ground clearance is increased by 65mm above normal ride height at speeds less than 50kph.



#### Torque Vectoring

Torque Vectoring uses the electronic differential and vehicle's brake system to constantly balance the distribution of engine torque between the four wheels when cornering, resulting in improved grip, steering and reduced understeer whilst maintaining a consistent speed.

Vehicle shown left is HSE in Firenze Red.

Visit [landrover.com](http://landrover.com) for more information.

## KEY FEATURES

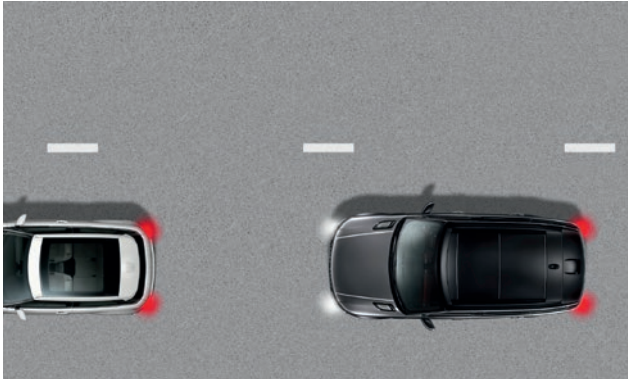

### Adaptive Cruise Control with Queue Assist, Intelligent Emergency Braking and Active Seat Belts

Adaptive Cruise Control (ACC) is an improved cruise control system that helps maintain a pre-set gap from the vehicle in front, even if it changes speed. Queue Assist extends the ACC functionality. It is designed to allow the vehicle to come to a stop when it reaches a traffic queue.

Intelligent Emergency Braking uses radar to detect vehicles travelling in the same direction and automatically reduces impact speed if it calculates that a frontal collision is unavoidable.



### Blind Spot Monitor with Closing Vehicle Sensing

Using sensors mounted on the sides and the rear bumper, these systems are designed to see what you might miss. When a vehicle enters a blind spot, a warning light will show in the corresponding door mirror.

Closing Vehicle Sensing scans a zone much further behind the vehicle, to help detect vehicles which are closing quickly from behind and which could cause a threat during a lane change manoeuvre.

Also available with Reverse Traffic Detection.

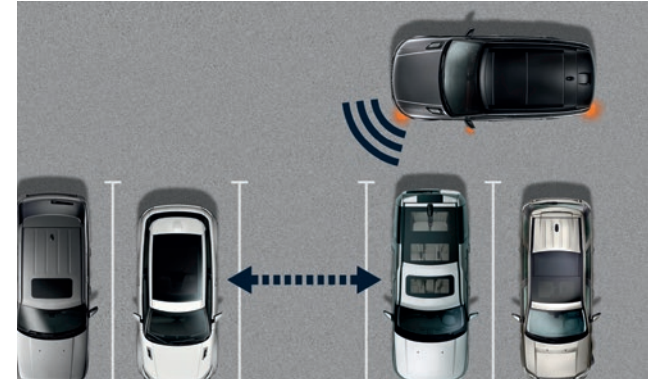

### Park Assist

Range Rover Sport has been designed and engineered to meet the needs of today. Parking is made simpler with the aid of Parallel Parking, a feature which can be further enhanced with the addition of Parallel Exit, Perpendicular Parking and 360° Park Distance Control. Whether you're manoeuvring around tight corners or negotiating traffic, the vehicle is agile.



### Traffic Sign Recognition with Lane Departure Warning

Traffic Sign Recognition uses the forward-looking camera to recognise speed limit signs and display the information in the instrument cluster.

Lane Departure Warning uses a forward-looking camera mounted in front of the rear view mirror to monitor lane markings on both sides of the vehicle. It gives a discrete warning in the form of a vibration through the steering wheel when the vehicle drifts out of its lane, triggering the indicators. (System operational at certain speeds).



### Adaptive Xenon Headlamps (including headlamp powerwash)

Signature design LED lights combine distinctive design with highly practical capabilities: dynamic Xenon lamps swivel to follow the road, while static bending lamps light the kerbside area in tight bends to give the driver a greater sense of confidence during night-time driving.



### Full Thin Film Transistor (TFT) Instrument Panel

The 12.3 inch virtual instrument panel uses state-of-the-art, high-resolution display technology and the latest colour graphics for clear communication of the main vehicle functions and data. With elegant virtual dials resembling 3D chrome it can be tailored to display only information that is relevant to the current driving situation.



#### Interior Mood Lighting

New levels of ambient refinement and personalisation have been reached with the option of customer configurable lighting. Using a combination of coloured LEDs, this feature allows occupants to vary the shade, changing the ambience of the cabin to suit their mood. There are ten colours in total to suit every taste and mood, ranging from Spark Blue through to Ice White and Racing Red.



#### Dual View Touch-Screen

Dual View technology enables driver and front passenger to view completely independent display content via the Touch-screen, so the passenger can watch TV while the driver follows navigational instructions.



#### Wade Sensing™

Using sensors in the wing mirrors when the vehicle is wading, it alerts the driver if the water is too deep. The feature is particularly useful when visibility is poor or when driving at night. This feature provides real-time pictorial wading information, including the depth of the water in relation to the vehicle, as well as maximum wading capability of the vehicle.



#### Audio

The Meridian™ audio technology gives you stunning sound quality. The top of the range system features Meridian Signature Reference Audio with 23 speakers including subwoofer and 3D surround sound.



#### Rear Seat Entertainment

The Rear Seat Entertainment System provides entertainment for rear passengers, with a choice of two eight-inch integrated or 10.2 inch video screens, a pair of WhiteFire® digital wireless headphones, one USB in the second row and a dedicated remote control.

It includes 'Journey Status', a Navigation Summary screen which displays a pop-up for the rear occupant detailing the time and distance to destination.



#### InControl™ Apps\*

Land Rover InControl™ Apps enables you to use vehicle optimised smartphone apps on the vehicle's Touch-screen. Using the InControl Apps USB port you can enjoy a variety of vehicle optimised apps such as: Contacts, Calendar and Music Player, with more third party vehicle optimised apps being released over time. Your smartphone will also be re-charged whilst using InControl Apps.

\*This feature is not available in all markets. Please consult your nearest Land Rover Dealer for details. WhiteFire® is a registered trademark of Unwired Technology LLC and any use of such marks by Land Rover is under licence.

# DIMENSIONS AND CAPABILITIES



Wheelbase 2,923mm



Height 1,780mm

Front wheel track 1,690mm



Rear wheel track 1,685mm



Width 2,073mm mirrors folded  
Width 2,220mm mirrors out

## Obstacle Clearance

Off-road height 278mm  
Standard ride height 213mm

## Standard Ride Height

With roof rails 1,780mm  
With roof antenna 1,801mm  
With panoramic roof open 1,817mm  
Access height air suspension setting will reduce each of the above by 50mm

## Loadspace Capacity

Rear seats upright  
Height 767mm, Width 1,285mm  
Loadspace volume 784 litres  
Loadspace width between arches 1,120mm  
Length at floor 1,043mm-1,143mm  
Rear seats forward  
Height 767mm, Width 1,285mm  
Loadspace volume 1,761 litres  
Loadspace width between arches 1,120mm  
Length at floor 1,871mm

## Headroom

Maximum front headroom with LR2  
Rear headroom 993mm



Overall length 4,850mm

## Turning Circle

Kerb-to-kerb 12.3m  
Wall-to-wall 12.5m  
Turns lock-to-lock 2.78



	A	B	C
Ride Height			
Off-road (Hybrid)	33.0°	27.2° (25.9°)	31.0°
Standard (Hybrid)	24.3°	19.4° (18.9°)	24.9°



## Wading Depth

Maximum wading depth 850mm



# TECHNICAL SPECIFICATION / PERFORMANCE AND KEY DATA

	3.0L TDV6 DIESEL	3.0L SDV6 DIESEL	3.0L SDV6 HYBRID DIESEL	4.4L SDV8 DIESEL	3.0L V6 PETROL	5.0L V8 SUPERCHARGED PETROL
<b>ENGINE DATA</b>						
Capacity (cc)	2,993	2,993	2,993	4,367	2,995	4,999.7
No. of cylinders	6	6	6	8	6	8
Cylinder layout	Longitudinal V6	Longitudinal V6	Longitudinal V6	Longitudinal V8	Longitudinal V6	Longitudinal V8
Valves per cylinder	4	4	4	4	4	4
Bore (mm)	84	84	84	84	84.5	92.5
Stroke (mm)	90	90	90	98.5	89	93
Compression ratio (:1)	16.1	16.1	16.1	16.1	10.5	9.5
Maximum power kW (PS) / rpm	190 (258) / 4,000	215 (292) / 4,000	250 (340) / 4,000**	250 (339) / 3,500	250 (340) / 6,500	375 (510) / 6,000 – 6,500
Maximum torque Nm / rpm	600 / 2,000	600 / 2,000	700 / 1,500 – 3,000**	740 / 1,750 – 2,300	450 / 3,000 – 5,000	625 / 2,500 – 5,500
<b>BRAKES</b>						
Front type	Ventilated disc	Ventilated disc	Ventilated disc	Ventilated disc	Ventilated disc	Ventilated disc
Front diameter (mm)	350	380	380	380	350	380
Rear type	Ventilated disc	Ventilated disc	Ventilated disc	Ventilated disc	Ventilated disc	Ventilated disc
Rear diameter (mm)	350	365	365	365	350	365
<b>WEIGHTS (kg)</b>						
Weight	2,115	2,115	2,372	2,398	2,147	2,335
Maximum laden weight (5 seat / 5+2 Seating)	3,020 / 3,170	3,020 / 3,170	3,150 / 3,250	3,200 / 3,250	2,950	3,050 / 3,200
Maximum mass on each axle (front)	1,500	1,500	1,500	1,500	1,500	1,500
Maximum mass on each axle (rear) (5 seat / 5+2 Seating)	1,775 / 1,900	1,775 / 1,900	1,775 / 1,900	1,775 / 1,900	1,730	1,775 / 1,900
<b>TOWING (kg)</b>						
Unbraked Trailer	750	750	750	750	750	750
Maximum towing	3,500	3,500	3,000	3,500	3,500	3,500
Maximum coupling poiny /nose weight	150	150	120	150	150	150
Maximum vehicle and trailer combination / Gross Train Weight (5 seat / 5+2 Seating)	6,500 / 6,650	6,500 / 6,650	6,150 / 6,250	6,700 / 6,750	6,450	6,550 / 6,700
<b>ROOF CARRYING (kg)</b>						
Maximum roof load (including roof rails)	100	100	100	100	100	100
<b>PERFORMANCE AND FUEL ECONOMY</b>						
Maximum speed kph / mph	210 / 130	210 (222*) / 130 (138*)	210 (225*)	210 (225*)	210 / 130	225 (250*) / 140 (155*)
Acceleration (secs) 0-100kph	7.6	7.2	6.7	6.9	7.2	5.3
Acceleration (secs) 0-60 mph	7.1	6.8	6.4	6.5	6.9	5.0
Fuel tank capacity – usable (litres)	80	80	80	105	105	105
Diesel Particulate Filter (DPF)	■	■	■	■	–	–

\*Only available on Dynamic Pack models. \*\*When combined with electric motor.

■ Standard – Not Available.

## ACCESSORIES





**Deployable Side Steps\***  
 VPLWP0192, VPLWP0191, VPLWP0177, VPLWP0173 and either VPLWP0178, VPLWP0181 (Lane Departure equipped vehicles), VPLWP0179 (5+2 Seating equipped vehicles) or VPLWP0180 (5+2 Seating equipped vehicles with Lane Departure).

These smart, practical steps make it easier to get in and out of the vehicle. Neatly stowed under the sills, the Side Steps automatically deploy as soon as the door is opened, or when activated by the key fob. They stow automatically when the door is closed.



**Fixed Side Step\***  
 VPLGP0226

The Fixed Side Steps aid entry and exit to the vehicle and improve access to the roof. Design features include Range Rover branding and bright anodised aluminium edge trim finish to complement vehicle styling cues. Compatible with Wade Sensing™ at 2015 model year. Vehicle software update allows compatibility for earlier model year vehicles.



**Side Tubes\***  
 VPLWP0154

Manufactured from stainless steel with a highly polished finish, this product helps protect the vehicle in off-road conditions. Its rugged off-road appearance complements the vehicle's exterior design.



**Stainless Steel Front Undershield**  
 VPLWP0162

The off-road inspired styled undershield features a premium bright polished finish for the front of the vehicle.



**Stainless Steel Rear Undershield**  
 VPLWP0163

**Stainless Steel Rear Undershield (Towing)\*\***  
 VPLWP0164



**Body Side Mouldings**  
 VPLWP0159

Providing protection for your door panels from accidental damage by adjacent vehicles. Painted to match your vehicle's body colour, ensuring a premium finish and maintaining the overall aesthetics of your Range Rover Sport.

\*Fitting of Side Steps or Side Tubes may affect the off-road capability of the vehicle.  
 \*\*Can be used with Electrically Deployable Tow Bar VPLWT0111.

## ACCESSORIES



20 INCH FIVE SPLIT-SPOKE  
'STYLE 520'  
WITH GLOSS BLACK FINISH  
VPLWW0090\*



21 INCH FIVE SPLIT-SPOKE  
'STYLE 507'  
WITH GLOSS BLACK FINISH  
VPLWW0091\*



21 INCH FORGED NINE-SPOKE  
'STYLE 705'  
WITH FULL MACHINE POLISHED FINISH  
VPLWW0083\*



21 INCH FORGED NINE-SPOKE  
'STYLE 705'  
WITH LOW GLOSS FINISH  
VPLWW0084\*



21 INCH FORGED NINE-SPOKE  
'STYLE 705'  
WITH SATIN BLACK FINISH  
VPLWW0085\*



22 INCH FORGED FIVE SPLIT-SPOKE  
'STYLE 514'  
WITH MACHINE POLISHED FINISH  
VPLWW0086\*†

\*Rim only. Centre caps available separately.  
†Not available with 5+2 Seating.



22 INCH FORGED FIVE SPLIT-SPOKE  
'STYLE 514'  
WITH CERAMIC POLISHED FINISH  
VPLWW0088\*†



22 INCH FORGED FIVE SPLIT-SPOKE  
'STYLE 514'  
FULLY PAINTED WITH TECHNICAL GREY FINISH  
VPLWW0087\*†



22 INCH FORGED FIVE SPLIT-SPOKE  
'STYLE 514'  
FULLY PAINTED WITH LOW GLOSS BLACK FINISH  
VPLWW0089\*†

### Accessory Wheels

A range of exclusive premium wheels offered for Range Rover Sport. Available in a variety of finishes and premium materials including forged aluminium. The wheels available are 20 inch, 21 inch and 22 inch.

## ACCESSORIES



**Stainless Steel Sports Pedals**  
VPLGS0160 – LHD  
VPLGS0161 – RHD

Stainless Steel pedals feature a bright design and hidden fixings for a clean finish.



**Premium carpet mats**  
LR041635 – Ebony – LHD  
LR041633 – Ebony – RHD  
LR041634 – Espresso – LHD  
LR041632 – Espresso – RHD

2,050g weight deep pile carpet mats with waterproof backing.



**Rubber floor mats**  
VPLWS0190 – LHD  
VPLWS0189 – RHD

Rubber footwell mats for front and second row occupants help provide protection from general dirt.



**Illuminated Treadplates**  
VPLWS0208

Illuminated treadplates are available on both the driver and front passenger sides of the vehicle to welcome you into the cabin.



**Personalised Illuminated Treadplates**  
VPLWS0212 – Front  
VPLWS0209 – Vehicle Set

You can personalise your vehicle further by adding a script of your choice in a variety of fonts which will be highlighted by subtle white illumination. Available as a full vehicle set (front pair personalised, rear pair illuminated only) or as a front pair only.



**Door Sill Outer Treadplate**  
VPLWS0207

An aluminium enhancement for the outer door sills featuring a laser etched 'Sport' motif.



**Luggage Divider – Full Height**  
VPLWS0235

The Luggage Divider is designed to prevent cargo from entering the passenger compartment. It incorporates a useful integral ski hatch that allows longer items to be carried where a suitable rear seat option is fitted.

**Luggage Divider – Half Height**  
VPLWS0236

**Luggage Divider – Loadspace Partition**  
VPLWS0237



**Illuminated Rear Loadspace Treadplate Finisher**  
VPLWS0211PVJ – Ebony  
VPLWS0211AAM – Espresso

Manufactured from stainless steel with a bright finish, protecting the loadspace trim when loading or unloading. Providing a premium finish to the loadspace with subtle illumination.



**Rear Loadspace Treadplate Finisher**  
VPLWS0210PVJ – Ebony  
VPLWS0210AAM – Espresso

Manufactured from stainless steel with a bright finish, protecting the loadspace trim when loading or unloading.



**Loadspace Stowage Rails**  
VPLWS0242 – 5 Seat  
VPLWS0243 – 5+2 Seating

Loadspace mounted rails to facilitate flexible stowage solutions. Loadspace Stowage Rails allow fitment of the Luggage Retention Kit.

**Luggage Retention Kit**  
VPLGS0171

Pack of attachments that fix into the loadspace rails via a quick lock/quick release system to provide a flexible solution for retaining items. The attachment pack includes a retractable strap with inertia reel, telescopic rod and stowage bag.



**Loadspace Mat – Rubber**  
VPLWS0225

Range Rover branded rubber mat helps to protect the rear loadspace carpet from general dirt. Rubber mat extension for protection of the back of the rear seats when folded down also available – Part No: VPLWS0223



**Loadspace Liner Tray**  
VPLWS0224

This liner provides superior protection to the loadspace floor and side wall carpets from dirty or wet equipment.

## ACCESSORIES



**Roof Rails\***  
VPLWR0104 – Black Finish†  
VPLWR0103 – Silver Finish††

Roof Rails facilitate easy fitment of cross bars. Pre-set positioning points ensure cross bars are fixed in optimum position for weight distribution and dynamics.

Maximum load capacity is 100kg and incremental height when fitted is 88mm.

**Cross Bars\***  
VPLGR0102

T-track design utilises the full length of the bars, providing space to mount multiple accessories. Aerodynamic profile minimises drag and noise. Roof rails not included.

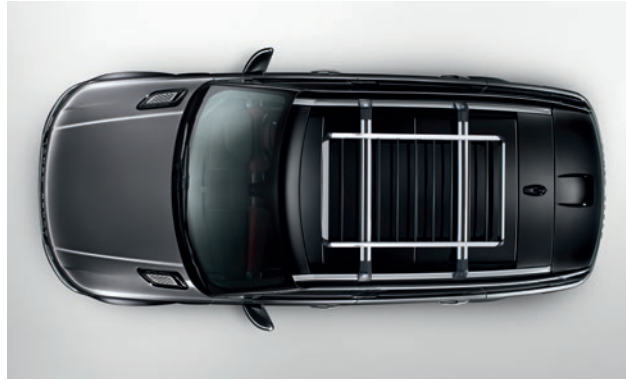

**Luggage Carrier\***  
LR006848

Flexible rack system to facilitate roof carrying. Maximum payload 75kg.\*\*

**Roof Mounted Bike Carrier (not shown)\***  
VPLFR0091

**Roof Mounted Bike Carrier – Fork Mounted with Wheel Carrier (not shown)\***  
VPLWR0101

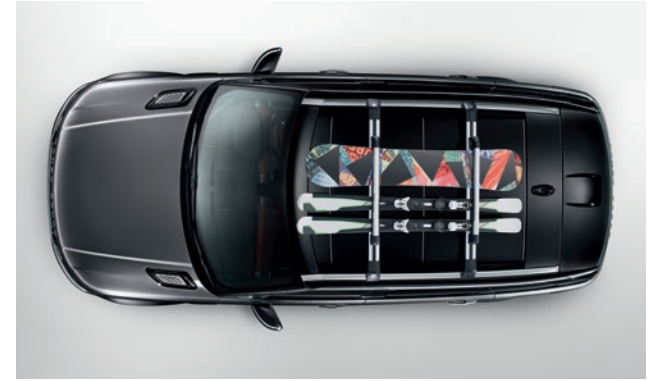

**Ski/Snowboard Holder\* – LR006849**

Carries four pairs of skis or two snowboards. Lockable for security. Maximum payload 36kg.\*\*

**Aqua Sports Carrier (not shown) – VPLGR0107**

Carries one surfboard, sailboard, canoe or kayak. Includes lockable multi-purpose holder to carry a mast, oars or paddles. Tilts to facilitate easy loading/unloading. Maximum payload 45kg.\*\*

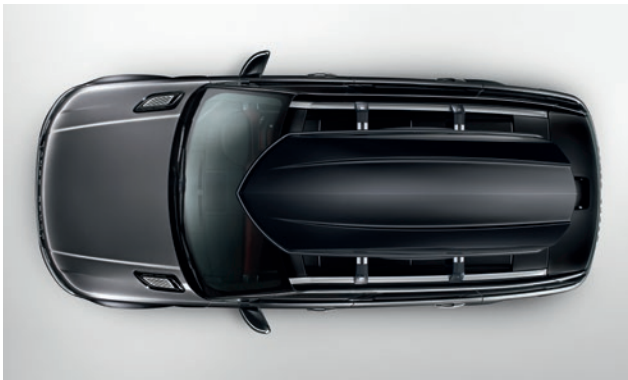

**Large Sports Roof Box\***  
VPLWR0100

Featuring a quick mounting system for easy secure fixation. Includes integrated base mat with a non-slip surface for extra secure loading. Capable of carrying up to four pairs of skis or five snowboards. Volume 430 litres. Maximum payload 75kg.\*\*



**Luggage Box\***  
VPLVR0062

The gloss black finish Luggage Box opens from both sides and includes power-grip mounting for easy and quick fixing to the roof bars. Lockable for security. Volume 410 litres. Maximum payload 75kg.\*\*



**Tow Bar Mounted Bike Carrier**  
**Two Bike Carrier – VPLVR0067 – LHD / VPLVR0066 – RHD**  
**Three Bike Carrier – VPLVR0069 – LHD / VPLVR0068 – RHD**  
**Four Bike Carrier – VPLVR0106 – LHD / VPLVR0105 – RHD**

Tow bar mounted bike carrier available for two, three or four bikes. Featuring LED lighting, licence plate mount, a quick release design for ease of use and lockable for security. Maximum load capacity 60kg (on the four bike carrier).

Two Bike or Three Bike Carriers require a separate heat shield for fitment – Part No: VPLWR0124

Four Bike Carriers require a separate heat shield for fitment – Part No: VPLWR0123

\*Roof Rails and Cross Bars are required for all Land Rover roof mounted accessories. Objects placed above the roof mounted satellite antenna may reduce the quality of the signal received by the vehicle and could have a detrimental effect on the navigation and satellite radio system, if fitted.

\*\*Maximum payload equals the load capacity of the roof mounted accessory. †Roof Rail Ditch Finishers required for fitment with Black Finish Roof Rails – VPLWR0108.

††Roof Rail Ditch Finishers required for fitment with Silver Finish Roof Rails – VPLWR0109.





**Outdoor Car Cover**  
VPLWC0061

All weather tailored cover protects your Range Rover Sport from the elements.



**Windscreen Sun Shield**  
VPLWS0231

Helps to keep the vehicle interior cool in hot weather.



**Noble Plated Mirror Caps**  
VPLGB0073

Noble Plated Mirror Caps complement the Range Rover Sport's exterior styling cues.

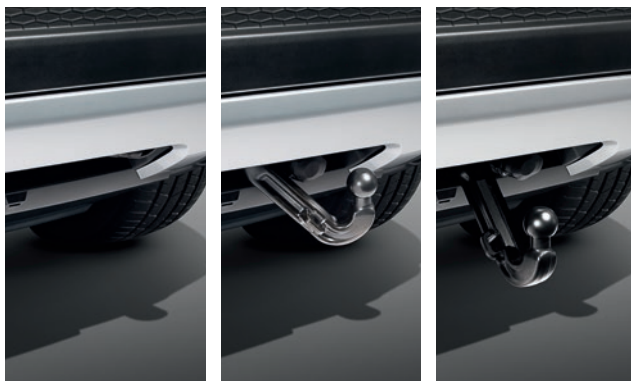

**Electrically Deployable Tow Bar**  
VPLWT0111, VPLWT0123, VPLWT0122 and either VPLWB0140, VPLWB0135 or VPLWB0138

The Electrically Deployable Tow Bar is stowed discreetly behind the bumper, providing a clean attractive finish. It is designed to deploy/stow in 12 seconds. Approved for up to 3,500kg trailer load.



**Multi-Height Tow Bar and Armature**  
VPLWT0159 and either VPLWB0139, VPLWB0136 or VPLWB0137

Bespoke Range Rover Sport system offers three different towing height options and the ability to swap heights in a matter of seconds. Approved for 3,500kg trailer load.



**Towing Electrics – 13 Pin**  
VPLWT0114

European-style towing electrics, capable of supplying all trailer rear lighting and interior equipment power. Offered for Multi-Height Tow Bar.



**Front Mudflaps**  
VPLWP0165

Front Mudflaps for Deployable Side Steps (not shown)  
VPLWP0167

**Rear Mudflaps**  
VPLWP0166

Mudflaps reduce spray and help protect the paintwork. Supplied as a pair.

\*Towing load capacity on Hybrid is 3,000Kg.





BY APPOINTMENT TO  
HER MAJESTY THE QUEEN  
MANUFACTURERS OF  
MOTOR VEHICLES  
JAGUAR LAND ROVER LIMITED  
COVENTRY



BY APPOINTMENT TO  
HIS ROYAL HIGHNESS THE DUKE OF EDINBURGH  
MANUFACTURERS OF  
MOTOR VEHICLES  
JAGUAR LAND ROVER LIMITED  
COVENTRY



BY APPOINTMENT TO  
HIS ROYAL HIGHNESS THE PRINCE OF WALES  
MANUFACTURERS OF  
MOTOR VEHICLES  
JAGUAR LAND ROVER LIMITED  
COVENTRY

**IMPORTANT NOTICE:** Jaguar Land Rover Limited is constantly seeking ways to improve the specification, design and production of its vehicles and alterations take place continually. Whilst every effort is made to produce up to date literature, this brochure should not be regarded as an infallible guide to current specifications, nor does it constitute an offer for the sale of any particular vehicle. Distributors and dealers are not agents of Jaguar Land Rover Limited by any express or implied undertaking or representation.

All Land Rover Approved Accessories fitted by a Land Rover Dealer within one month or 1,600 kilometres/1,000 miles (which ever occurs first) of the handover of a new registered vehicle will benefit from the same warranty terms and period of cover as the vehicle warranty. Accessories purchased outside of these parameters will be subject to a 12 month unlimited mileage warranty. All Land Rover Approved Accessories are rigorously tested to the same exacting standards as those applied to our vehicles. Performance in extreme hot and cold temperatures, corrosion resistance, impact and airbag deployment highlight some of the exhaustive product testing carried out to ensure accessories are both durable and importantly, continue to comply with current legislation.

All our accessories are designed to be an integral part of Land Rover vehicles. While many items such as roof carriers are simple to fit, some products require specialist tools and diagnostic equipment to ensure correct integration with the vehicle structure and electrical systems. These products vary from market to market, please consult your Land Rover Dealer who will be pleased to advise you on current specifications and any query you may have.

The colours reproduced here are subject to the limitations of the printing process and may therefore vary slightly from the actual vehicle. The company reserves the right to alter or withdraw any colour finish without notice. Some of these colours may not be obtainable in your country. Please check availability of colours and current specifications with your Land Rover Dealer. Distributors and dealerships are not agents of Jaguar Land Rover Limited and have absolutely no authority to bind Jaguar Land Rover Limited to any express or implied undertaking or representation.

Castrol EDGE Professional exclusively recommended by Land Rover.

Vehicle shown left is Autobiography with Dynamic Pack in Chile (Red).

**Jaguar Land Rover** Registered Office:  
Abbey Road, Whitley, Coventry CV3 4LF  
United Kingdom.

Registered in England: Number 1672070

landrover.com

© Jaguar Land Rover Limited 2014. Publication Number: LRML 4647/14



# RANGE ROVER SPORT

## 2015 AUSTRALIAN SPECIFICATIONS

The information in product brochure LRML 4647/14 is produced for global English markets and may include models, technical data, specifications and accessories not available in Australia. This section of the brochure includes specific Australian models, specifications and options availability.



ABOVE AND BEYOND

# RANGE ROVER SPORT

RANGE ROVER SPORT MODEL	3.0L TDV6 DIESEL	3.0L SDV6 DIESEL	3.0L SDV6 HYBRID	4.4L SDV8 DIESEL	3.0L V6 SUPERCHARGED PETROL	5.0L V8 SUPERCHARGED PETROL
S	■					
SE	■	■			■	
HSE		■	■	■	■	
HSE Dynamic				■		■
Autobiography		■	■			
Autobiography Dynamic						■
Recommended Retail Price (RRP)						
<b>3.0L TDV6 DIESEL (190kW)</b>						
S						POA
SE						POA
<b>3.0L SDV6 DIESEL (215kW)</b>						
SE						POA
HSE						POA
Autobiography						POA
<b>3.0L SDV6 DIESEL HYBRID (250kW)</b>						
HSE						POA
Autobiography						POA
<b>4.4L SDV8 DIESEL (250kW)</b>						
HSE						POA
HSE Dynamic						POA
<b>3.0L V6 SUPERCHARGED PETROL (250kW)</b>						
SE						POA
HSE						POA
<b>5.0L V8 SUPERCHARGED PETROL (375kW)</b>						
HSE Dynamic						POA
Autobiography Dynamic						POA

## TECHNICAL SPECIFICATIONS

ENGINE DATA	3.0L TDV6 DIESEL	3.0L SDV6 DIESEL	3.0L SDV6 HYBRID	4.4L SDV8 DIESEL	3.0L V6 SUPERCHARGED PETROL	5.0L V8 SUPERCHARGED PETROL
Capacity (cc)	2,993	2,993	2,993	4,367	2,995	5,000
No. of cylinders	6	6	6	8	6	8
Cylinder layout	Longitudinal V6	Longitudinal V6	Longitudinal V6	Longitudinal V8	Longitudinal V6	Longitudinal V8
Valves per cylinder	4	4	4	4	4	4
Bore (mm)	84.0	84.0	84.0	84.0	84.5	92.5
Stroke (mm)	90.0	90.0	90.0	98.5	89.0	93.0
Compression ratio (:1)	16.1	16.1	16.1	16.1	10.5	9.5
Maximum power (kW @ rpm)	190 @ 4,000	215 @ 4,000	250 @ 4,000	250 @ 3,500	250 @ 6,500	375 @ 6,000-6,500
Maximum torque (Nm @ rpm)	600 @ 2,000	600 @ 2,000	700 @ 1,500-3,000	740 @ 1,750-2,300	450 @ 3,500-5,000	625 @ 2,500-5,500

# TECHNICAL SPECIFICATIONS (CONT)

	3.0L TDV6 DIESEL	3.0L SDV6 DIESEL	3.0L SDV6 HYBRID	4.4L SDV8 DIESEL	3.0L V6 SUPERCHARGED PETROL	5.0L V8 SUPERCHARGED PETROL
<b>BRAKES</b>						
Front type	Ventilated disc	Ventilated disc	Ventilated disc	Ventilated disc	Ventilated disc	Ventilated disc
Front diameter (mm)	350	380	380	350	350	380
Rear type	Ventilated disc	Ventilated disc	Ventilated disc	Ventilated disc	Ventilated disc	Ventilated disc
Rear diameter (mm)	350	365	365	350	350	365
<b>WEIGHTS (kg)</b>						
Weight from	2,115	2,115	2,372	2,398	2,144	2,310
Gross Vehicle Weight (5 seats/5 + 2 Seats)	3,000/3,150	3,000/3,150	3,150/3,250	3,200/3,250	2,950/3,100	3,050/3,250
Maximum mass on front axle (5 seats/5 + 2 Seats)	1,500/1,500	1,500/1,500	1,550/1,550	1,500/1,500	1,500/1,500	1,500/1,500
Maximum mass on rear axle (5 seats/5 + 2 Seats)	1,775/1,900	1,775/1,900	1,775/1,900	1,775/1,900	1,775/1,900	1,775/1,900
<b>TOWING (kg)</b>						
Unbraked trailer	750	750	750	750	750	750
Maximum towing	3,500	3,500	3,000	3,500	3,500	3,500
Maximum coupling point/nose weight	350	350	300	350	350	350
Maximum vehicle and trailer combination (5 seats/5 + 2 Seats)	6,500/6,650	6,500/6,650	6,150/6,250	6,700/6,750	6,450/6,600	6,550/6,700
<b>ROOF CARRYING (kg)</b>						
Maximum roof load (including roof rails)	100	100	100	100	100	100
<b>PERFORMANCE</b>						
Maximum speed (km/h)	210	210	210	210	210	225
Acceleration 0-100 km/h (secs)	7.6	7.2	6.7	6.9	7.2	5.3
Fuel tank capacity – usable (litres)	80	80	80	105	105	105
<b>FUEL ECONOMY</b>						
Urban (l/100km)	8.3	8.7	6.7	11.5	15.4	20.6
Extra urban (l/100km)	6.7	6.8	6.3	7.6	8.9	9.9
Combined (l/100km)	7.3	7.5	6.4	8.7	11.3	13.8
CO2 combined emissions (g/km)	194	199	169	229	264	322

# TRANSMISSION AND DRIVING DYNAMICS

TRANSMISSION	CODE	TDV6 S	TDV6 SE	SDV6 SE	SDV6 HSE	SDV6 AUTO-BIOGRAPHY	SDV8 HSE	V6 SC SE	V6 SC HSE
8-Speed Automatic Transmission		■	■	■	■	■	■	■	■
Stop/Start		■	■	■	■	■	–	–	–
Paddle Shift	078CB	\$460	\$460	\$460	■	■	■	■	■
Premium Paddle Shift – Noble Plated	078CC	\$570	\$570	\$570	\$110	\$110	\$110	\$110	\$110
Single Speed Transfer Box (High Range Only)	043BE	■	■	–	–	–	–	■	■
Twin Speed Transfer Box (High/Low Range)	043BF	–	–	■	■	■	■	P1	P1
<b>FUEL SYSTEM</b>									
Fuel Flap – Requires central locking		■	■	■	■	■	■	■	■
Diesel Particulate Filter (DPF)		■	■	■	■	■	■	–	–
No Diesel Particulate Filter (DPF)		–	–	–	–	–	–	■	■

## TRANSMISSION AND DRIVING DYNAMICS (CONT)

DRIVING AND DYNAMICS	CODE	TDV6 S	TDV6 SE	SDV6 SE	SDV6 HSE	SDV6 AUTO-BIOGRAPHY	SDV8 HSE	V6 SC SE	V6 SC HSE
Anti-lock Braking System (ABS)		■	■	■	■	■	■	■	■
Cornering Brake Control (CBC)		■	■	■	■	■	■	■	■
Dynamic Stability Control (DSC)		■	■	■	■	■	■	■	■
Emergency Brake Assist (EBA)		■	■	■	■	■	■	■	■
Electronic Brake-Force Distribution (EBD)		■	■	■	■	■	■	■	■
Speed Proportional Electric Power Assisted Steering (EPAS)		■	■	■	■	■	■	■	■
Electronic Traction Control (ETC)		■	■	■	■	■	■	■	■
Gradient Acceleration Control (GAC)		■	■	■	■	■	■	■	■
Gradient Release Control (GRC)		■	■	■	■	■	■	■	■
Hill Descent Control (HDC)		■	■	■	■	■	■	■	■
Electric Parking Brake		■	■	■	■	■	■	■	■
Electronic 4 Corner Air Suspension (4CAS) Cross-Requires Auto Load Levelling		■	■	■	■	■	■	■	■
Reactive Grounding Response		■	■	■	■	■	■	■	■
Active Vanes (Upper Only)		■	■	■	■	■	■	-	-
Terrain Response®		■	■	-	-	-	-	■	■
Terrain Response® 2 Auto	0881A	-	-	■	■	■	■	P1	P1
Adaptive Dynamics	027CW	-	-	■	■	■	■	P1	P1
Dynamic Response™	027AM	-	-	P2	P2	P2	■	-	-
Dynamic Program	0881B	-	-	P2	P2	P2	■	-	-
Torque Vectoring	027DC	-	-	P2	P2	P2	■	-	-
Red Painted Brake Calipers	020BE	-	-	\$800	\$800	\$800	\$800	-	-

## EXTERIOR FEATURES AND FINISHERS

GLASS AND EXTERIOR MIRRORS	CODE	TDV6 S	TDV6 SE	SDV6 SE	SDV6 HSE	SDV6 AUTO-BIOGRAPHY	SDV8 HSE	V6 S/C SE	V6 S/C HSE
Acoustic Laminated Windscreen		■	■	■	■	■	■	■	■
Power Windows (front and rear) with Remote Power Locking (Global Close)		■	■	■	■	■	■	■	■
Rain Sensing Windscreen Wipers		■	■	■	■	■	■	■	■
Heated Off Screen Wiper		■	■	■	■	■	■	■	■
Heated Rear Window		■	■	■	■	■	■	■	■
Rear Wash Wiper		■	■	■	■	■	■	■	■
Toughened Front, Rear Door and Quarter Light Glass		■	-	-	-	-	-	-	-
Laminated Front Door, Toughened Rear Door and Quarter Light Glass		-	■	■	■	■	■	■	■
Metal Roof		■	■	■	■	■	■	■	■
Fixed Panoramic Roof (includes power blinds)	041CX	\$3,400	\$3,400	\$3,400	\$3,400	\$3,400	\$3,400	\$3,400	\$3,400
Sliding Panoramic Roof (includes power blinds)	041CZ	\$4,200	\$4,200	\$4,200	\$4,200	\$4,200	\$4,200	\$4,200	\$4,200
Heated Windscreen	040AK	\$440	\$440	\$440	\$440	\$440	\$440	\$440	\$440
Solar Attenuating Windscreen (N/A with 047AB Glass)	047AH	\$1,400	\$1,400	\$1,400	\$1,400	\$1,400	\$1,400	\$1,400	\$1,400
Privacy Glass – rear of B pillar (N/A with 047AH Windscreen)	047AB	\$900	\$900	\$900	\$900	\$900	\$900	\$900	\$900
Privacy Glass with Solar Attenuating Glass – rear of B pillar (N/A with 047AB Glass)	047AV	\$2,300	\$2,300	\$2,300	\$2,300	\$2,300	\$2,300	\$2,300	\$2,300



# EXTERIOR FEATURES AND FINISHERS (CONT)

GLASS AND EXTERIOR MIRRORS	CODE	TDV6 S	TDV6 SE	SDV6 SE	SDV6 HSE	SDV6 AUTO-BIOGRAPHY	SDV8 HSE	V6 S/C SE	V6 S/C HSE
Power Adjustable, Heated Exterior Mirrors with Auto Reverse Dipping		■	■	■	–	–	–	■	–
Power Adjustable, Heated Exterior Mirrors with Auto Reverse Dipping, Approach Lamps & Power Folding <i>(Memory function added when fit with memory seats)</i>	030NM	\$600	\$600	\$600	■	■	■	\$600	■
Power Adjustable, Heated Exterior Mirrors with Auto Reverse Dipping, Approach Lamps, Power Folding & Auto Dimming <i>(Requires 030NY interior mirror. Memory function added when fit with memory seats)</i>	031EB	\$1,000	P21	P21	P22	\$400	P22	P21	P22
<b>HEADLAMPS &amp; LIGHTING</b>									
Follow-Me-Home Lighting		■	■	■	■	■	■	■	■
Daytime Running Lights (DRL)		■	■	■	■	■	■	■	■
Automatic Headlamps		■	■	■	■	■	■	■	■
LED Rear Lamps		■	■	■	■	■	■	■	■
Front Fog Lamps		■	■	■	■	■	■	■	■
Rear Fog Lamps		■	■	■	■	■	■	■	■
Side Repeater Indicators in Mirror		■	■	■	■	■	■	■	■
Centre High Mounted Stop Lamp		■	■	■	■	■	■	■	■
Hazard Lights Under Heavy Braking		■	■	■	■	■	■	■	■
Halogen Headlamps		■	■	■	–	–	–	■	–
Xenon Headlamps with LED Signature & Headlamp Powerwash	064CW	P20	P21	P21	■	■	■	P21	■
Adaptive Xenon Headlamps with LED Signature & Headlamp Powerwash	064DI	–	–	–	\$1,000	\$1,000	\$1,000	–	\$1,000
Automatic Headlamps with High Beam Assist (AHBA)	030NT	P20	P21	P21	P22	■	P22	P21	P22
<b>PAINT</b>									
Solid Paint		■	■	■	■	■	■	■	■
Metallic Paint	024AZ	\$2,100	\$2,100	\$2,100	\$2,100	\$2,100	\$2,100	\$2,100	\$2,100
Premium Metallic Paint	024BR	\$4,200	\$4,200	\$4,200	\$4,200	\$4,200	\$4,200	\$4,200	\$4,200
<b>TRIM &amp; STYLING</b>									
Body Colour Mirror Cap		■	■	■	■	■	■	■	■
Black Colour Mirror Caps		–	–	–	–	–	–	–	–
Twin Tailpipe		■	■	■	■	■	■	■	■
Bright Twin Tailpipe		–	–	–	–	–	–	–	–
Body Coloured Roof	080AC	■	■	■	■	■	■	■	■
Contrast Roof – Corris Grey	080EE	\$1,400	\$1,400	\$1,400	\$1,400	●	\$1,400	\$1,400	\$1,400
Contrast Roof – Santorini Black	080AN	\$1,400	\$1,400	\$1,400	\$1,400	●	\$1,400	\$1,400	\$1,400
Contrast Roof – Indus Silver	080AD	\$1,400	\$1,400	\$1,400	\$1,400	●	\$1,400	\$1,400	\$1,400
Painted Front and Rear Bumpers and Side Sills			–	–	–	■	–	–	–
<b>TOWING</b>									
Trailer Stability Control		■	■	■	■	■	■	■	■
Front and Rear Recovery Hooks		■	■	■	■	■	■	■	■
3500kg Towing Capacity		■	■	■	■	■	■	■	■
Towhitch Receiver – includes electrics & armature	028EL	\$950	\$950	\$950	\$950	\$950	\$950	\$950	\$950

## EXTERIOR FEATURES AND FINISHERS (CONT)

WHEELS & TYRES	CODE	TDV6 S	TDV6 SE	SDV6 SE	SDV6 HSE	SDV6 AUTO-BIOGRAPHY	SDV8 HSE	V6 S/C SE	V6 S/C HSE
19" 5 Split Spoke – 'Style 501' (N/A with 033BI 5+2 seating)	029SA	■	■	–	–	–	–	■	●
19" 5 Split Spoke – 'Style 501' with Satin Dark Grey Finish (N/A with 033BI 5+2 seating)	029XR	\$800	\$800	–	–	–	–	\$800	●
20" 5 Split Spoke – 'Style 520'	029SB	\$2,400	\$2,400	■	■	●	■	\$2,400	■
21" 5 Split-Spoke – 'Style 507'	029SD	\$4,000	\$4,000	\$2,400	\$2,400	■	\$2,400	\$4,000	\$2,400
21" 5 Split Spoke – Diamond Turned Finish – 'Style 507'	029SE	–	–	–	\$3,200	\$800	\$3,200	–	\$3,200
22" 5 Split Spoke – 'Style 504' (N/A with 033BI 5+2 seating)	029SF	\$5,600	\$5,600	\$4,000	\$4,000	\$2,400	\$4,000	\$5,600	\$4,000
Locking Wheel Nuts		■	■	■	■	■	■	■	■
Full Size Spare Wheel		■	■	■	■	■	■	■	■
Tyre Repair System (Requires 5+2 Seating. N/A with Full Size/Reduced Section Spare Wheel)	029FJ	●	●	●	●	●	●	●	●
Reduced Section Spare Wheel (N/A with 033BI 5+2 seating or Full Size Spare Wheel)	029QQ	●	●	●	●	●	●	●	●
Tyre Pressure Monitoring System (TPMS)	062AD	\$900	\$900	\$900	\$900	\$900	\$900	\$900	\$900

## INTERIOR FEATURES AND FINISHERS

SEATING MATERIAL – FRONT AND REAR	CODE	TDV6 S	TDV6 SE	SDV6 SE	SDV6 HSE	SDV6 AUTO-BIOGRAPHY	SDV8 HSE	V6 S/C SE	V6 S/C HSE
Cloth	033TA	■	–	–	–	–	–	–	–
Grained Leather	033TB	\$4,720	■	■	–	–	–	■	–
Oxford Perforated Leather (N/A with Style 1 Seats, Requires 033SY Seats)	033JK	–	\$2,870	\$2,870	■	–	■	\$2,870	■
Oxford Perforated Leather with Autobiography Pattern (single/duo/tri tone)		–	–	–	–	■	–	–	–
<b>SEATING FUNCTIONALITY</b>									
Head restraints 2 Way Adjust for Driver and Passenger		■	■	■	■	■	■	■	■
Seat Map Pockets		■	■	■	■	■	■	■	■
Style 1 – 6/4 Way Manual Seats (with Powered High Adjust)		■	■	■	–	–	–	■	–
Style 2 – 14/14 Way Powered Seats	033SY	–	●	●	■	–	■	●	■
Style 3 – 14/14 Way Powered Seats with Memory (Requires 030NM or 031EB Mirrors)	033KZ	–	\$2,090	\$2,090	–	–	–	\$2,090	–
Style 5 – 18/18 Way Powered Seats with Memory	033UA	–	–	–	P24	■	P24	–	P24
Style 7 – 18/18 Way Powered Seats with Memory and Front Seat Articulation and Massage (Requires Climate Front Seats. N/A with 129AH Rear Seat Entertainment)	033TR	–	–	–	–	\$2,720	–	–	–
Heated Front Seats with Heated Rear Seats	033EQ	P4	P4	P4	P4	–	P4	P4	P4
Climate Front Seats with Heated Rear Seats	033GQ	–	–	–	–	■	–	–	–
Climate Front Seats with Climate Rear Seats (Requires 022BG 4 Zone Climate Control)	033IN	–	–	–	\$3,200	\$700	\$3,200	–	\$3,200

# INTERIOR FEATURES AND FINISHERS (CONT)

SEATING FUNCTIONALITY – REAR	CODE	TDV6 S	TDV6 SE	SDV6 SE	SDV6 HSE	SDV6 AUTO-BIOGRAPHY	SDV8 HSE	V6 S/C SE	V6 S/C HSE
Headrests (3x) with 2-way Adjust for 2nd row seats		■	■	■	■	■	■	■	■
Centre Armrest		■	■	■	■	■	■	■	■
60/40 Folding Rear Seats	033CY	■	■	■	■	■	■	■	■
60/40 Folding Rear Seats with Load Through	033CW	\$260	\$260	\$260	\$260	\$260	\$260	\$260	\$260
Powered 5+2 Seating (N/A with 19" or 22" Wheels. Requires 033CW Seating & 029FJ Tyre Repair System)	033BI	\$3,700	\$3,700	\$3,700	\$3,700	\$3,700	–	\$3,700	\$3,700
<b>STEERING WHEEL</b>									
Manual Steering Column	049AK	■	■	■	–	–	–	■	–
Power Adjustable Steering Column	049AL	–	\$860	\$860	■	■	■	\$860	■
Leather Steering Wheel with Multifunctional Controls		■	■	■	■	■	■	■	■
Heated Leather Steering Wheel	032FB	\$500	\$500	\$500	\$500	\$500	\$500	\$500	\$500
<b>TRIM FINISH</b>									
Dark Brushed Metal Aluminium Trim Finisher		■	■	■	–	–	–	■	–
Micro Mesh Metal Aluminium Trim Finisher		–	–	–	■	–	■	–	■
Shadow Zebrano Veneer	088HB	–	\$880	\$880	\$880	■	\$880	\$880	\$880
Dark Grey Oak Veneer	088GM	–	\$880	\$880	\$880	●	\$880	\$880	\$880
Grand Black Veneer	088HS	–	–	–	\$880	\$880	\$880	–	\$880
Shadow Zebrano Autobiography Extended Veneer including additional Ambient Lighting (Replaces 064FC Interior Lighting)	088JC	–	–	–	–	\$660	–	–	–
Dark Grey Oak Autobiography Extended Veneer including additional Ambient Lighting (Replaces 064FC Interior Lighting)	088HZ	–	–	–	–	\$660	–	–	–
Grand Black Autobiography Extended Veneer including additional Ambient Lighting (Replaces 064FC Interior Lighting)	088JD	–	–	–	–	\$1,540	–	–	–
Front And Rear Carpet Mats	079AJ	\$260	\$260	\$260	–	–	–	\$260	–
Premium Front And Rear Carpet Mats	079CA	\$440	\$440	\$440	P22	■	P22	\$440	P22
Plastic Treadplates		■	■	■	–	–	–	■	–
Alluminium Tread Plates with Range Rover lettering	048AR	–	\$440	\$440	■	■	■	\$440	■
Illuminated Alluminium Tread Plates with Range Rover lettering	048BD	\$2,190	\$2,190	\$2,190	\$1,750	\$1,750	\$1,750	\$2,190	\$1,750
Morzine Headlining (Cirrus or Ivory dependant on colourway)	088HH	■	■	■	■	■	■	■	■
Morzine Headlining (Ebony)	005BJ	–	\$880	\$880	\$880	\$880	\$880	\$880	\$880
Alston Headlining (Cirrus, Ivory or Ebony dependant on colourway)	088HE	\$3,700	\$3,700	\$3,700	\$3,700	\$3,700	\$3,700	\$3,700	\$3,700

# SAFETY AND SECURITY

	CODE	TDV6 S	TDV6 SE	SDV6 SE	SDV6 HSE	SDV6 AUTO-BIOGRAPHY	SDV8 HSE	V6 S/C SE	V6 S/C HSE
Remote Power Central Double locking		■	■	■	■	■	■	■	■
Drive Away Auto Lock (customer configurable) and Crash Unlock System		■	■	■	■	■	■	■	■
Single point entry, customer configurable		■	■	■	■	■	■	■	■
Power Operated Child Locks		■	■	■	■	■	■	■	■
Restraints – Airbags, Inflatable Lanceless Curtain System		■	■	■	■	■	■	■	■
Restraints – Airbags, Side (Seat-Front, Thorax & Pelvis) (Driver and Passenger)		■	■	■	■	■	■	■	■

## SAFETY AND SECURITY (CONT)

	CODE	TDV6 S	TDV6 SE	SDV6 SE	SDV6 HSE	SDV6 AUTO-BIOGRAPHY	SDV8 HSE	V6 S/C SE	V6 S/C HSE
Seat Belt Pre-Tensioners Front with load limiting device and height adjustable		■	■	■	■	■	■	■	■
Dual Stage (2 stage airbag)		■	■	■	■	■	■	■	■
Rollover Deployment of Restraints		■	■	■	■	■	■	■	■
Roll Stability control (RSC)		■	■	■	■	■	■	■	■
Adjustable Speed Limiter Device		■	■	■	■	■	■	■	■
Perimetric Alarm		■	■	■	■	■	■	■	■
Volumetric Alarm (includes all perimetric features plus tilt sensor & battery backed sounder)	076EL	\$1,100	P23	P23	P24	\$1,100	P24	P23	P24
First Aid Kit	056AZ	\$110	P23	P23	P24	\$110	P24	P23	P24

## COMFORT AND CONVENIENCE FEATURES

COMFORT & CONVENIENCE	CODE	TDV6 S	TDV6 SE	SDV6 SE	SDV6 HSE	SDV6 AUTO-BIOGRAPHY	SDV8 HSE	V6 S/C SE	V6 S/C HSE
Push Button Start Stop		■	■	■	■	■	■	■	■
Rear Park Distance Sensors with Visual Display		■	■	■	■	■	■	■	■
Cruise Control		■	■	■	■	■	■	■	■
Front Parking Aid with Front Visual Display	086EG	P20	P21	P21	■	■	■	P21	■
Park Assist – Parallel Park (Requires 086EG front park aid)	086GZ	\$1,490	\$1,490	\$1,490	\$1,490	\$1,490	\$1,490	\$1,490	\$1,490
Park Assist – Parallel Park/Perpendicular Park/360 degree Parking Sensors (Requires 086EG front park aid)	086HA	\$2,960	\$2,960	\$2,960	\$2,960	\$2,960	\$2,960	\$2,960	\$2,960
Rear View Camera with visual guidance and hitch assist function		■	■	■	■	■	■	■	■
Surround Camera System (Requires 030NM Exterior Mirrors)	086GC	\$1,800	\$1,800	\$1,800	\$1,800	\$1,800	\$1,800	\$1,800	\$1,800
Blind Spot Monitor with Closing Vehicle Sensing (Requires 031EB Mirrors)	086GH	\$1,200	\$1,200	\$1,200	\$1,200	\$1,200	\$1,200	\$1,200	\$1,200
Blind Spot Monitoring with Closing Vehicle Sensing and Reverse Traffic Detection (Requires 031EB Exterior Mirrors)	086GF	\$1,420	\$1,420	\$1,420	\$1,420	\$1,420	\$1,420	\$1,420	\$1,420
Wade Sensing™ plus Blind Spot Monitoring with Closing Vehicle Sensing and Reverse Traffic Detection (Requires 031EB Mirrors & 086GC Surround Camera)	074NG	\$2,220	\$2,220	\$2,220	\$2,220	\$2,220	\$2,220	\$2,220	\$2,220
Wade Sensing™ (Requires 030NM Exterior Mirrors. N/A with 086GH, 086GC or 031EB)	075EA	\$800	\$800	\$800	\$800	\$800	\$800	\$800	\$800
Lane Departure Warning (Requires 030NT Headlamps and 031EB Exterior Mirrors)	086BC	\$1,400	\$1,400	\$1,400	\$1,400	\$1,400	\$1,400	\$1,400	\$1,400
Adaptive Cruise Control with Queue Assist, Intelligent Emergency Braking & Active Seat Belts	065AG	\$4,700	\$4,700	\$4,700	\$4,700	\$4,700	\$4,700	\$4,700	\$4,700
Homelink – Garage Door Opener (Requires 030NY Interior Mirror)	025FG	\$700	\$700	\$700	\$700	\$700	\$700	\$700	\$700
Soft Door Close (Requires 066AC Keyless Entry)	076FC	\$1,100	\$1,100	\$1,100	\$1,100	\$1,100	\$1,100	\$1,100	\$1,100
Keyless Entry	066AC	\$2,400	\$2,400	\$2,400	■	■	■	\$2,400	■
Park Heating with Remote Control	043AV	\$3,300	\$3,300	\$3,300	\$3,300	\$3,300	\$3,300	\$3,300	\$3,300
Extra Large Additional Water Bottle (Requires 064DW or 064DI Xenon lights)	039BB	\$110	\$110	\$110	\$110	\$110	\$110	\$110	\$110

# COMFORT AND CONVENIENCE FEATURES (CONT)

INTERIOR FEATURES	CODE	TDV6 S	TDV6 SE	SDV6 SE	SDV6 HSE	SDV6 AUTO-BIOGRAPHY	SDV8 HSE	V6 S/C SE	V6 S/C HSE
Driver and Passenger Sunvisor with Illuminated Vanity Mirror		■	■	■	■	■	■	■	■
Front Map Lights		■	■	■	■	■	■	■	■
Centre Arm Rest with Cubby Box		■	■	■	■	■	■	■	■
Front Door Mini Stowage Pocket with Rubber Mat		■	■	■	■	■	■	■	■
Front and Rear Cupholders		■	■	■	■	■	■	■	■
Secure Glove Box Stowage		■	■	■	■	■	■	■	■
Single Blade Sunvisor		■	■	■	■	■	■	■	■
Twin Blade Sunvisor	115AP	\$150	\$150	\$150	\$150	\$150	\$150	\$150	\$150
Manual Dimming Interior Mirror	030NV	■	-	-	-	-	-	-	-
Auto Dimming Interior Mirror	030NY	\$330	■	■	■	■	■	■	■
Front Centre Console Cooler Compartment	038EA	\$800	\$800	\$800	\$800	■	\$800	\$800	\$800
2 Zone Climate control	022AY	■	■	■	■	■	■	■	■
3 Zone Climate Control	022BC	\$1,800	\$1,800	\$1,800	\$1,800	\$1,800	\$1,800	\$1,800	\$1,800
4 Zone Climate Control	022BG	\$3,200	\$3,200	\$3,200	\$3,200	\$3,200	\$3,200	\$3,200	\$3,200
Interior Mood Lighting	064EC	■	■	■	■	-	■	■	■
Customer Configurable Interior Mood Lighting	064FC	\$770	\$770	\$770	P22	■	P22	\$770	P22
Non Smokers Pack (Stowage Bin)		■	■	■	■	■	■	■	■
Smokers Pack (Front and rear cigar lighter & ash tray)	094AA	●	●	●	●	●	●	●	●
<b>LOADSPACE</b>									
Roller Loadspace Cover		■	■	■	■	■	■	■	■
Load Compartment Light		■	■	■	■	■	■	■	■
Mounting Provisions – for Loadspace and Dog Guard		■	■	■	■	■	■	■	■
Handbag Hook/Curry Hook in Loadspace		■	■	■	■	■	■	■	■
Secure Stowage		■	■	■	■	■	■	■	■
Manual Single Piece Tailgate		■	-	-	-	-	-	-	-
Power Single Piece Tailgate	070AW	\$1,200	■	■	■	■	■	■	■
Loadspace Stowage Rails	135AH	\$720	\$720	\$720	\$720	\$720	\$720	\$720	\$720
<b>INFORMATION, COMMUNICATION</b>									
8" Touch Screen		■	■	■	■	■	■	■	■
Voice Control		■	■	■	■	■	■	■	■
Bluetooth® Phone connection & Audio Streaming		■	■	■	■	■	■	■	■
MP3 Compatible Audio Disk		■	■	■	■	■	■	■	■
USB Socket – (1x at row 1)		■	■	■	■	■	■	■	■
Auxiliary power sockets (front, second row and loadspace 12 volt)		■	■	■	■	■	■	■	■
Auxiliary Device Connectivity (Full Integrated streaming)		■	■	■	■	■	■	■	■
User Selectable Screen Savers		■	■	■	■	■	■	■	■
Range Rover Audio System (250W) with 8 speakers	025MC	■	■	■	■	-	■	■	■
Meridian Surround Sound Audio System (825W) with 19 speakers	025LN	\$2,900	\$2,900	\$2,900	\$2,900	■	\$2,900	\$2,900	\$2,900
Meridian Signature Reference Audio System (1700W) with 23 speakers	025LV	-	-	-	\$13,600	\$10,700	\$13,600	-	\$13,600
Digital Audio Broadcast Radio (DAB+)	025JB	\$900	\$900	\$900	\$900	\$900	\$900	\$900	\$900
Hard Disk Navigation System with Hard Disk Audio Server & Voice Control	087AA	●	■	■	■	■	■	■	■

## COMFORT AND CONVENIENCE FEATURES (CONT)

INFORMATION, COMMUNICATION	CODE	TDV6 S	TDV6 SE	SDV6 SE	SDV6 HSE	SDV6 AUTO-BIOGRAPHY	SDV8 HSE	V6 S/C SE	V6 S/C HSE
Analogue Speedometer and Tachometer with 5" TFT Instrument Cluster	038IC	■	■	■	■	■	–	■	■
12.3" TFT Virtual Instrument Panel	038ID	\$1,500	P23	P23	P24	\$1,500	■	P23	P24
Rear Seat Entertainment with 8.0" Screen, DVD and SSD player, remote control and 2 sets of WhiteFire™ headphones with USB in 2nd row (Requires 033CW Seating and 025LN or 025LV Audio Systems)	129AH	–	\$5,000	\$5,000	\$5,000	\$5,000	\$5,000	\$5,000	\$5,000
Rear Seat Entertainment with 10.2" Screen, DVD and SSD player, remote control and 2 sets of WhiteFire™ headphones with USB in 2nd row (Requires 033CW Seating and 025LN or 025LV Audio Systems)	129AQ	–	–	–	–	\$6,500	–	–	–
Television – Digital	129AA	P25	P25	P25	P25	P25	P25	P25	P25
Touch Screen with Dual View technology (includes one set of WhiteFire™ headphones) (Requires 025LN or 025LV Audio Systems)	087AM	P25	P25	P25	P25	P25	P25	P25	P25

## OPTION PACKS

	CODE	TDV6 S	TDV6 SE	SDV6 SE	SDV6 HSE	SDV6 AUTO-BIOGRAPHY	SDV8 HSE	V6 S/C SE	V6 S/C HSE
<b>Off Road Pack (P1) – V6S</b> Terrain Response® 2 Auto, Twin Speed Transfer Box (High/Low Range), Adaptive Dynamics	074QA	–	–	–	–	–	–	\$3,680	\$3,680
<b>On/Off Road Pack (P2) – SDV6</b> Terrain Response® 2 Auto, Dynamic Response, Torque Vectoring Dynamic Programme	074QC	–	–	\$8,100	\$8,100	\$8,100	–	–	–
<b>Heated/Cold Climate with Heated Windscreen Pack (P4)</b> Heated Front Seats, Heated Rear Seats, Heated Windscreen	072AC	\$1,900	\$1,900	\$1,900	\$1,900	–	\$1,900	\$1,900	\$1,900
<b>Comfort Pack (P20) – S Unlock Pack</b> Front Parking Aid with Front Visual Display, Xenon Headlamps with LED Signature, Headlamp Powerwash, Automatic Headlamps with High Beam Assist	075FC	\$3,290	–	–	–	–	–	–	–
<b>Comfort Pack (P21) – SE Unlock Pack</b> Front Parking Aid with Front Visual Display, Auto Dimming Exterior Mirrors, Xenon Headlamps with LED Signature, Headlamp Powerwash, Automatic Headlamps with High Beam Assist	075FD	–	●	●	–	–	–	●	–
<b>Comfort Pack (P22) – HSE Unlock Pack</b> Premium Front And Rear Carpet Mats, Automatic Headlamps with High Beam Assist, Auto Dimming Exterior Mirrors, Customer Configurable Mood Lighting	075FE	–	–	–	●	–	●	–	●
<b>SE Luxury Pack (P23)</b> 12.3" TFT Virtual Instrument Panel, Volumetric Alarm with Battery Back-up Sounder, First Aid Kit	074GR	–	\$2,300	\$2,300	–	–	–	\$2,300	–
<b>HSE Luxury Pack (P24)</b> 12.3" TFT Virtual Instrument Panel, Volumetric Alarm with Battery Back-up Sounder, First Aid Kit, Style 5 – 18/18 Way Powered Seats with Memory	074HY	–	–	–	●	–	●	–	●
<b>Audio Visual Pack (P25)</b> Digital TV, Touch Screen with Dual View Technology (includes one set of wireless headphones) (Requires 025LN or 025LV audio system)	074NC	\$3,870	\$3,870	\$3,870	\$3,870	\$3,870	\$3,870	\$3,870	\$3,870

# RANGE ROVER SPORT DYNAMIC

Exclusive features for the Range Rover Sport Dynamic models include a Gloss Black Grille, Fender Vent, Bonnet Vent and Mirror Caps. A red Sport Badge and Brake Calipers are also available.

HSE DYNAMIC	CODE	SDV8 HSE DYNAMIC	V8SC HSE DYNAMIC
Features in addition to SDV6 HSE standard equipment:			
<b>ENGINE</b>			
4.4L SDV8 Diesel (250kW)		■	-
5.0L V8 Supercharged Petrol (375kW)		-	■
<b>FUEL SYSTEM</b>			
Diesel Particulate Filter (DPF)		■	-
<b>TRANSMISSION</b>			
No Stop/Start		■	■
<b>DRIVING AND DYNAMICS</b>			
Active Vanes (Upper Only)		■	-
Dynamic Response™	027AM	■	■
Dynamic Program	088IB	■	■
Torque Vectoring	027DC	■	■
Performance Enhancement (increase in Top Speed)		■	■
Red Painted Brake Calipers	020BE	■	■
<b>TRIM &amp; STYLING</b>			
Black Colour Mirror Caps		■	■
Bright Twin Tailpipe		■	■
Contrast Roof – Corris Grey	080EE	●	●
Contrast Roof – Santorini Black	080AN	●	●
Contrast Roof – Indus Silver	080AD	●	●
<b>WHEELS &amp; TYRES</b>			
20" 5 Split Spoke – 'Style 520'	029SB	●	●
21" 5 Split Spoke – 'Style 507'	029SD	●	●
21" 5 Split Spoke – Diamond Turned Finish – 'Style 507'	029SE	■	■
21" 9 Spoke – Satin Black Finish – 'Style 901' (Requires 074MM Stealth Pack)	029TN	\$800	\$800
22" 5 Split Spoke – 'Style 504' (N/A with 5+2 seating)	029SF	\$1,600	\$1,600
22" 5 Split Spoke – Satin Black Finish – 'Style 508' (Requires 074MM Stealth Pack. N/A with 5+2 seating)	029TP	\$2,400	\$2,400
<b>SEATING FUNCTIONALITY – REAR</b>			
Powered 5+2 Seating (N/A with 22" Wheels. Requires 033CW seating & 029FJ Tyre Repair System)	033BI	-	\$3,700
<b>TRIM FINISH</b>			
Sports Textured Metal Aluminium Trim Finisher		■	■
Stainless Steel Sports Pedals		■	■
Illuminated Aluminium Tread Plates with Range Rover lettering		■	■

# RANGE ROVER SPORT DYNAMIC (CONT)

OPTION PACKS	CODE	SDV8 HSE DYNAMIC	V8SC HSE DYNAMIC
<b>Stealth Pack</b> Satin Black: Mirror Caps, Exterior Accents, Range Rover script on tailgate and bonnet, Fog Lamp Bezels, Front Grille, Toweye Cover, Tailgate Finisher, Side & Fender Vent, mesh and Wheel Nuts, Gloss Black non-reflective surface headlamps <i>(Requires 029TN or 029TP Wheels)</i>	074MM	\$4,000	\$4,000
<hr/>			
AUTOBIOGRAPHY DYNAMIC	CODE	V8SC AUTO-BIOGRAPHY DYNAMIC	
Features in addition to SDV6 Autobiography standard equipment:			
<b>ENGINE</b>			
5.0L V8 Supercharged Petrol (375kW)			■
<b>TRANSMISSION</b>			
No Stop/Start			■
<b>DRIVING AND DYNAMICS</b>			
Active Vanes (Upper Only)			-
Dynamic Response™			■
Dynamic Program			■
Torque Vectoring			■
Performance Enhancement (increase in Top Speed)			■
Red Painted Brake Calipers			■
<b>TRIM AND STYLING</b>			
Black Colour Mirror Caps			■
<b>WHEELS &amp; TYRES</b>			
20" 5 Split Spoke – 'Style 520'	029SB		●
21" 5 Split-Spoke – 'Style 507'	029SD		●
21" 5 Split Spoke – Diamond Turned Finish – 'Style 507'	029SE		\$1,600
21" 5 Split Spoke – 'Style 505'	029SW		■
21" 6 Spoke – 'Style 602'	029TA		-
21" 6 Spoke – Diamond Turned Finish – 'Style 602'	029TB		-
21" 9 Spoke – Satin Black Finish – 'Style 901' <i>(Requires 074MM Stealth Pack)</i>	029TN		\$1,600
22" 5 Split Spoke – 'Style 504' <i>(N/A with 5+2 seating)</i>	029SF		\$2,400
22" 5 Split Spoke – 'Style 508' <i>(N/A with 5+2 seating)</i>	029SY		\$2,400
22" 5 Split Spoke – Satin Black Finish – 'Style 508' <i>(Requires 074MM Stealth Pack. N/A with 5+2 seating)</i>	029TP		\$3,200



# RANGE ROVER SPORT DYNAMIC (CONT)

TRIM AND FINISH	CODE	V8SC AUTO-BIOGRAPHY DYNAMIC
Dark Engine Turned Metal Aluminium Trim Finisher		■
Shadow Zebrano Veneer	088HB	●
Stainless Steel Sports Pedals		■
Illuminated Aluminium Tread Plates with Range Rover lettering	048BD	■
Morzine Headlining (Cirrus or Ivory dependant on colourway)	088HH	●
Morzine Headlining (Ebony)	005BJ	●
Alston Headlining (Cirrus, Ivory or Ebony dependant on colourway)	088HE	■
<b>INFORMATION, COMMUNICATION</b>		
12.3" TFT Virtual Instrument Panel	038ID	■
<b>OPTION PACKS</b>		
<b>Stealth Pack</b> Satin Black: Mirror Caps, Exterior Accents, Range Rover script on tailgate and bonnet, Fog Lamp Bezels, Front Grille, Toweye Cover, Tailgate Finisher, Side & Fender Vent mesh and Wheel Nuts, Gloss Black non-reflective surface headlamps (Requires 029TN or 029TP Wheels)	074MM	\$4,000

# RANGE ROVER SPORT HYBRID

Designed and engineered for a hybrid derivative from the start, the Range Rover Sport Hybrid makes no compromise to Land Rover's legendary breadth of capability. With a state-of-the-art diesel powertrain, which combines the 215kW 3.0-litre SDV6 engine with an integral 35kW/175Nm electric motor to produce 250kW, the Hybrid retains the dynamic driving experience of the other models, and with 700Nm of torque, all-terrain performance is exceptional.

HSE HYBRID	CODE	SDV6 HEV HSE
Features in addition to SDV6 HSE standard equipment:		
<b>ENGINE</b>		
3.0L SDV6 HEV (250kW)		■
<b>DRIVING AND DYNAMICS</b>		
Dynamic Response™		-
Dynamic Program		■
Torque Vectoring		■
<b>TOWING</b>		
3000kg Towing Capacity		■
<b>WHEELS &amp; TYRES</b>		
20" 5 Split Spoke – 'Style 520'	029SB	●
21" 5 Split Spoke – 'Style 507'	029SD	●
21" 5 Split Spoke – Diamond Turned Finish – 'Style 507'	029SE	\$1,600
21" 6 Spoke – 'Style 602'	029TA	■
21" 6 Spoke – Diamond Turned Finish – 'Style 602'	029TB	\$800
22" 5 Split Spoke – 'Style 504' (N/A with 5+2 seating)	029SF	\$2,400
<b>INFORMATION, COMMUNICATION</b>		
12.3" TFT Virtual Instrument Panel	038ID	■

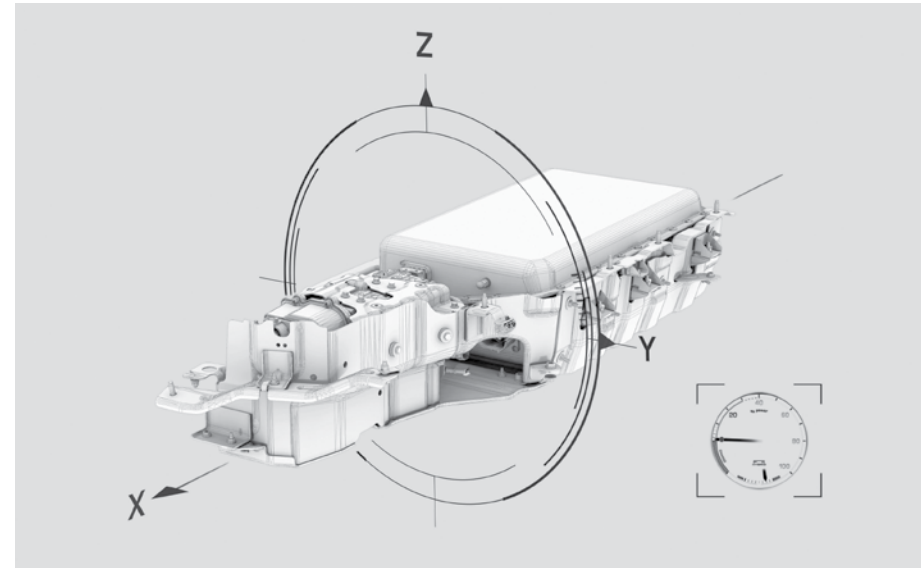

# RANGE ROVER SPORT HYBRID (CONT)

AUTOBIOGRAPHY HYBRID	CODE	SDV6 HEV AUTOBIOGRAPHY
Features in addition to SDV6 Autobiography standard equipment:		
<b>ENGINE</b>		
3.0L SDV6 HEV (250kW)		■
<b>DRIVING AND DYNAMICS</b>		
Dynamic Response™		-
Dynamic Program		■
Torque Vectoring		■
<b>TOWING</b>		
3000kg Towing Capacity		■
<b>WHEELS &amp; TYRES</b>		
21" 5 Split Spoke – 'Style 507'	029SD	●
21" 5 Split Spoke – Diamond Turned Finish – 'Style 507'	029SE	\$1,600
21" 6 Spoke – 'Style 602'	029TA	■
21" 6 Spoke – Diamond Turned Finish – 'Style 602'	029TB	\$800
<b>INFORMATION, COMMUNICATION</b>		
12.3" TFT Virtual Instrument Panel	038ID	■

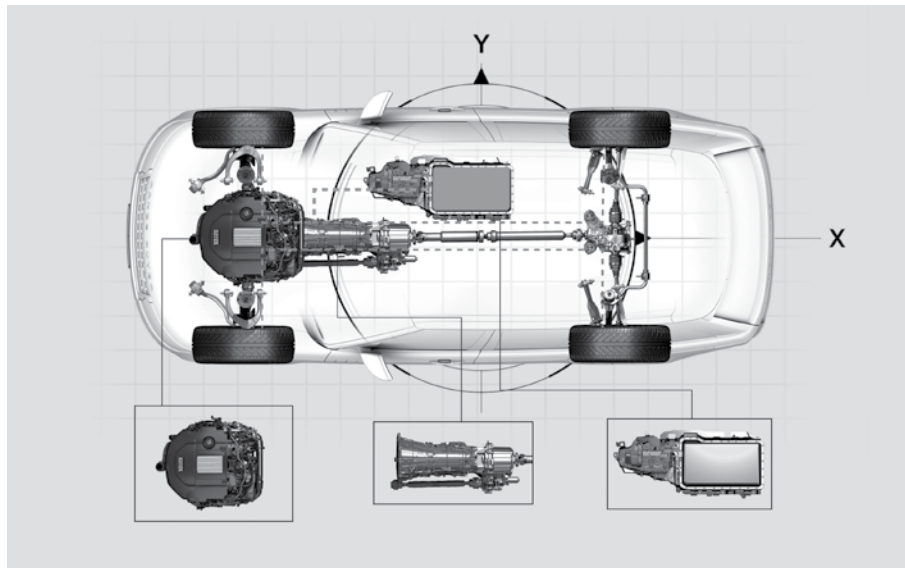

## **WARRANTY**

A comprehensive manufacturer's warranty is a feature of every Land Rover vehicle and extends to any genuine Land Rover accessories fitted by a Land Rover Retailer. The warranty period for the vehicle is three years/100,000 kilometres. In addition, the paint surface is also covered for three years/100,000 kilometres and the body work covered for corrosion for six years.

## **LAND ROVER ROADSIDE ASSISTANCE**

All Land Rover vehicles purchased in Australia benefit from complimentary Land Rover Roadside Assistance service for the length of the new car warranty. This covers you Australia-wide 24 hours per day every day. And because it is Land Rover Assistance, help will also be provided if you become bogged or disabled on roads that only four-wheel drives can travel.

## **CUSTOMER CARE**

Land Rover Australia has a dedicated Customer Care Centre to assist owners who may have a general query. Owners seeking this level of assistance are invited to phone our Customer Care Centre on the toll-free number 1800-625-642 or email [enquiries@landrovercustomers.com.au](mailto:enquiries@landrovercustomers.com.au). Land Rover ownership includes a package of benefits designed to provide high standards of after sales care and support.

## **LAND ROVER FINANCIAL SERVICES**

Just as Land Rover lets you tailor a vehicle to your specific requirements, we offer you the same service when it comes to finance. You can arrange to purchase and finance your Land Rover from the people who know it best – your Land Rover Dealer. Your Land Rover Business Manager can explain the full range of finance options available from Land Rover Financial Services and provide expert advice to help tailor a finance package to best suit your needs. To discover more about Land Rover Financial Services visit your nearest Land Rover Dealer, call 1300 555 211 or visit [www.landrover.com.au](http://www.landrover.com.au) for more information.

Land Rover Finance is provided by St. George Finance Limited (ABN 99 001 094 471) Australian Credit Licence 387944 to approved customers only. Credit criteria, fees, charges and terms and conditions apply.

## **LAND ROVER ASSURED EXTENDED WARRANTY**

Choose Land Rover Assured Extended Warranty Insurance for 12 or 24 months, up to 200,000 kilometres. Land Rover Assured Extended Warranty Insurance lets you enjoy your Land Rover both on and off the road without any concerns of the cost and inconvenience of mechanical failure. For a once off payment, you can enjoy the reassurance of protection against mechanical failures for up to 24 months with qualified repairs for the life of your warranty. Consult your Land Rover Retailer for more information.

The Bluetooth® word mark and logos are owned by the Bluetooth SIG, Inc. and any use of such marks by Land Rover is under license.

### **Important Notices:**

All details in this Recommended Retail Price list are believed to be correct as of September 2014. However, we are constantly striving for improvement and therefore reserve the right to alter price and specifications without notice. Distributors and retailers are not agents of Land Rover Australia and have no authority to bind Land Rover Australia to any expressed or implied undertaking or representation.

For further pricing information contact your local Land Rover dealer or go to the Driveaway Pricing Calculator at [www.landrover.com.au](http://www.landrover.com.au)

Jaguar Land Rover Australia Pty Ltd  
Trading as Land Rover Australia ABN 86 004 352 238  
65 Epping Road, North Ryde NSW 2113  
Locked Bag 2214, North Ryde NSW 1670  
©Jaguar Land Rover Australia Pty Ltd 2014  
**Publication Number LR9651 Range Rover Sport 10/14 Consumer**



ABOVE AND BEYOND