

RANGE ROVER



ABOVE AND BEYOND



RANGE ROVER 2015 – NEW ADDITIONS

Range Rover's exemplary levels of design and driving experience have been supplemented by new features and model variants for 2015.

AUTOBIOGRAPHY BLACK

Our most luxurious and alluring vehicle ever, Autobiography Black is the pinnacle of refinement. More details of this model are found on page 22.

InControl Apps™

In Control Apps is an optional feature that enables you to optimise smartphone apps on the vehicle's Touch-screen. Full details of this feature can be found on page 71 of this brochure.



OXFORD

Page 2



LOS ANGELES

Page 8



ROME

Page 16



LONDON

Page 22

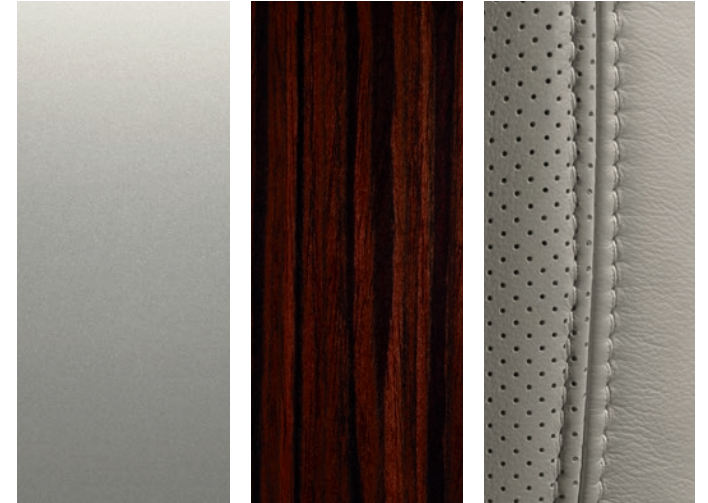

SPECIFICATIONS

Page 26





With its three classic lines of the lower accent graphic, roofline and continuous waistline, the Range Rover is unmistakable. The iconic silhouette is gently tapered and curved, while the use of near-flush glazing and gloss black pillars accentuates the floating roof enhancing its streamlined and elegant form.





With an all-aluminium body and true Land Rover capability at its heart, the Range Rover delivers incredible off-road performance with an impressive wading depth, raised air intake and class-leading departure angles. The Range Rover Hybrid is 100% Land Rover and 100% Hybrid. It delivers outstanding performance no matter what the terrain or conditions.



A sure-footed, composed drive is enhanced by the latest four-corner air suspension which provides exceptional wheel articulation and poise. The Auto setting on Terrain Response® 2, the latest generation Terrain Response system from Land Rover, automatically optimises vehicle settings to suit any terrain.

The split tailgate is distinctly Range Rover. Its electronically operated upper and lower tailgates help provide a platform for social and sporting events coupled with greater protection from the elements.







Refinement is inherent in the Range Rover. Its interior gives a sense of calm and luxurious comfort. It is beautifully appointed and thoughtfully designed; the broad centre console puts essential controls within easy reach while clean surfaces and the use of soft supple leather, wood veneers and highly polished finishers help create contemporary, comfortable surroundings.

Vehicle shown left is Autobiography in Indus Silver.

Interior colourway shown above in Espresso/Ivory with Ivory seats in Semi-Aniline leather with Figured Macassar Wood Veneer and optional heated wood and leather steering wheel.



Flooding the interior with light, both the fixed and sliding panoramic roof* enhance the feeling of space and a connection to the world outside. Yet, at the touch of a button, the driver and passengers can feel cocooned once more as the full-length power blind glides into place.

Interior colourway shown left in Espresso/Ivory with Ivory seats in Semi-Aniline leather and optional fixed panoramic roof.
*Both available as an option.



For pure indulgence and refinement in an SUV, nothing comes close. Whether passengers relax or work in the Rear Executive Class seats (available as an option), they will undoubtedly enjoy their individual leather seating with massage function and sweeping centre console.

Vehicle shown right is Autobiography in Indus Silver with optional sliding panoramic roof. Interior colourway shown in Ebony/Ivory with Ivory seats in Semi-Aniline leather and Figured Macassar Wood Veneer.







The exceptional quality of the Meridian™ sound system brings a concert hall experience into the Range Rover. Twenty-nine speakers ensure you hear every note while mood lighting creates the right ambience. There is a palette of ten colours to choose from and simply operated variable brightness controls can cater for every mood.

Interior colourway shown left is Autobiography with Rear Executive Class seats in Espresso/Ivory with Ivory seats in Semi-Aniline leather and Figured Macassar Wood Veneer.
Vehicle shown above is Autobiography in Aruba.





The overall sense of unparalleled comfort is realised in the Range Rover Long Wheelbase, providing an extra 186mm in the second row and affording rear passengers an extended recline.

Interior colourway shown left is Autobiography Long Wheelbase with Rear Executive Class seats in Ebony/Ivory with Ivory seats in Semi-Aniline leather and Grand Black Wood Veneer.

Vehicle shown above is Autobiography Long Wheelbase in Barolo Black.



To drive the Range Rover is to experience effortless elegance. From some of the most demanding and inhospitable terrains to negotiating rush hour city traffic, it delivers a relaxed, intuitive and rewarding drive.

Vehicle shown right is Autobiography Long Wheelbase in Barolo Black.

Interior colourway shown above in Espresso/Ivory with Ivory seats in Semi-Aniline leather, with Figured Macassar Wood Veneer and optional heated wood and leather steering wheel.







Range Rover's drive is confident and assured with the legendary Command Driving Position giving the driver the best possible view of the road ahead. Available as standard, the Adaptive Dynamics features variable dampers to deliver optimum ride, control and composure. The optional Dynamic Response* improves vehicle handling and occupant comfort by reducing the amount of body lean during cornering through independently regulating the front and rear suspension units. When you're in a Range Rover, the miles seem to fly by.

*Standard on SDV8 and V8 Supercharged engines.
Vehicle shown left and above is Autobiography Long Wheelbase in Barolo Black.





Henry Poole & Co, Savile Row, London

Craftsmanship never goes out of style and some forty years of expertise in designing Range Rover is now manifest in the new Autobiography Black model. From the unique front grille to the side and auxiliary vents, every tailored aspect whispers refinement and attention to detail.

Vehicle shown left is Autobiography Black Long Wheelbase in Valloire White Pearl from the Autobiography Paint Palette. Please contact your nearest Land Rover Dealer for further information.



Soft, supple and alluring to the touch, the very finest perforated Semi-Aniline leathers are featured on all seats. Sourced from one establishment, the hides are tanned through an organic process that features bark extract from Black Wattle trees. Sustainable woods and generous veneers on the centre console and fascia add to the sense of natural craft and refinement.



SPECIFICATION

Range Rover offers an exclusive range of options that allow you to personalise your vehicle. The following pages take you through a logical series of steps to bring your individuality to life.

You can start with our online configurator at landrover.com

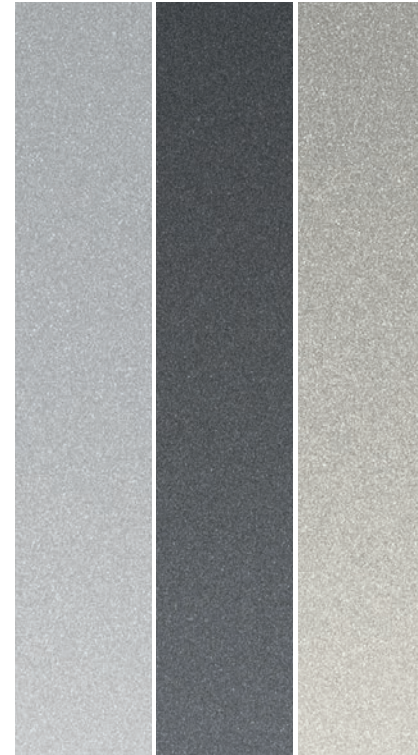
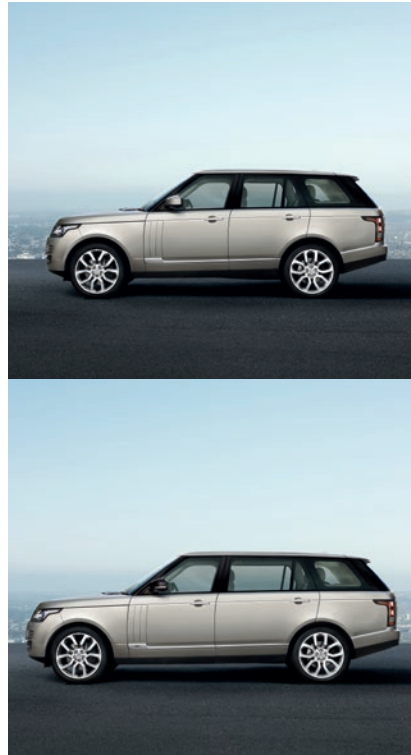

Hybrid

Page 28

The world's first Diesel Hybrid SUV.

Step 1

Choose your engine

Page 32

You can select from an improved and powerful range of petrol, diesel or hybrid engines.

Step 2

Choose your model

Page 34

Compare the standard features on each model, with the additional choice of Standard or Long Wheelbase versions.

Step 3

Choose your colour

Page 38

There is a wide range on offer to enable you to express yourself.

Step 4

Choose your wheels

Page 42

There is a range of styles, each one designed to complement the bold exterior.



Step 5

Choose your interior

Page 44

Carefully selected colours complemented by wood veneers. You can personalise your own interior space.

Key Features

Page 68

The latest innovations that make your drive special.

Technical Details

Page 72

All you need to know about dimensions, performance specifications and key data.

Accessories

Page 74

Additional accessories can enhance your personal requirements.

RANGE ROVER HYBRID

Range Rover Hybrid is the first diesel SUV of its kind in the world. It has been designed and engineered to deliver class-leading capability and versatility. By fully integrating the hybrid technologies into the chassis, nothing has been lost in ground clearance, approach and departure angles or the 900mm wading depth. The vehicle truly is 100% Hybrid, 100% Land Rover.

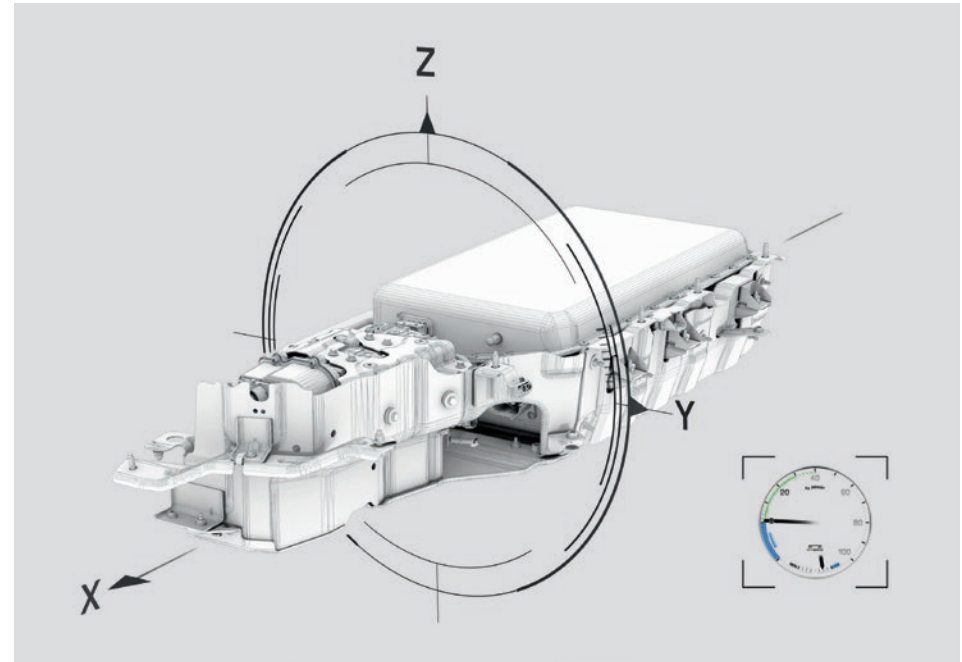

Range Rover Hybrid has been tested on the most demanding terrains, rigs and under the same extremes as every Land Rover. Hybrid technologies deliver impressive efficiencies. The 3.0L SDV6 Diesel engine with a 35kW electric motor generates the same performance as the SDV8 Diesel but with 14% lower (27g/km less) CO₂ emissions when compared to the TDV6 engine at 169g/km.

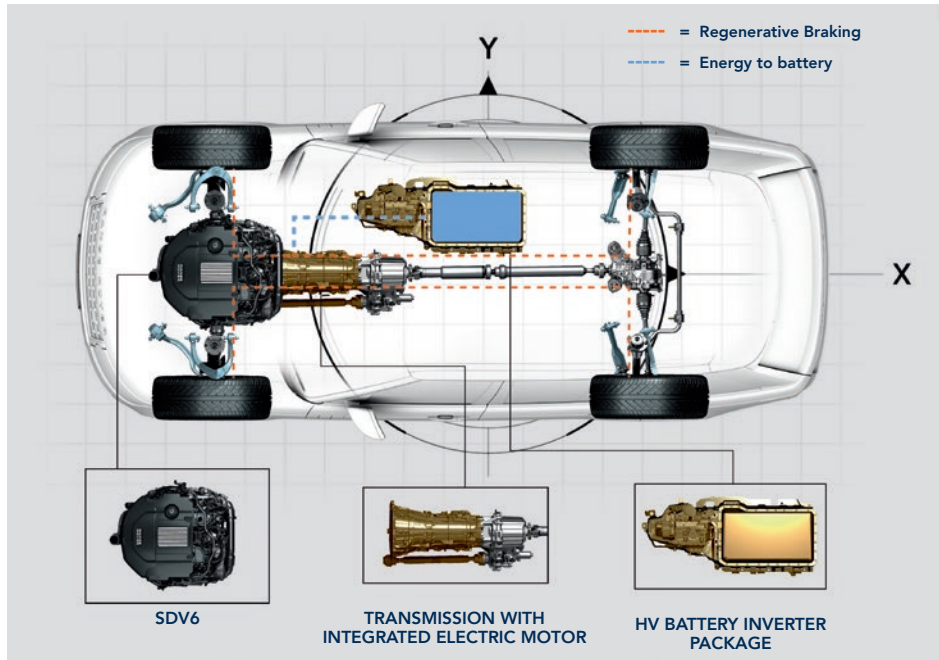

Innovative engineering ensures the transmission of energy between battery and engine is seamless. This energy is created by the Regenerative Braking process, which captures and stores kinetic energy in the battery, normally lost through braking. This is then used to power the electric motor and ensures that torque is instantly available on demand.

RANGE ROVER HYBRID

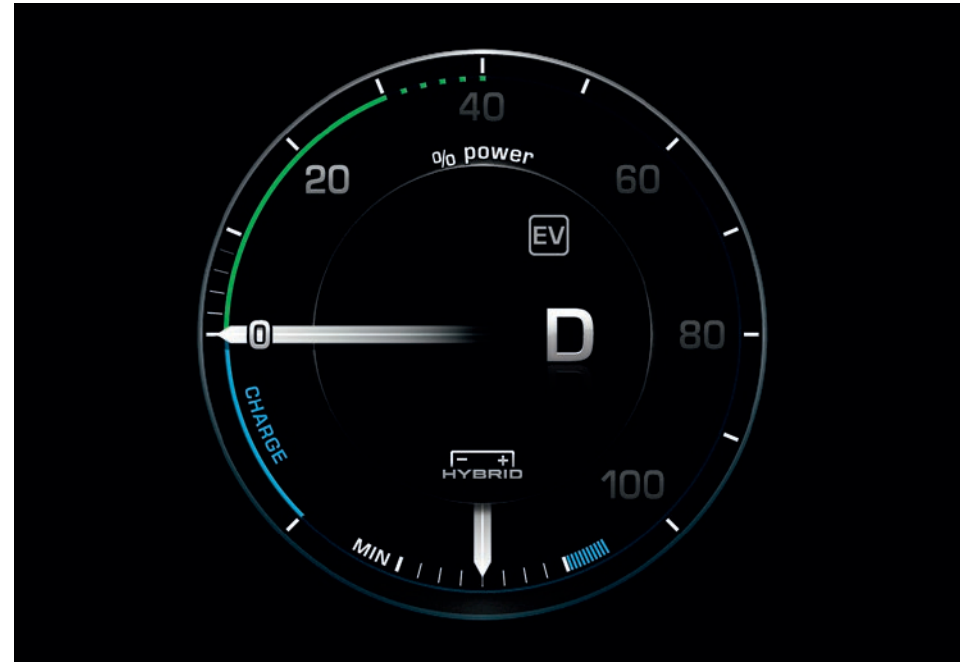

Select from four Hybrid driving modes to tailor the vehicle's performance to your requirements.

- EV** EV On Mode: Optimises hybrid battery power and is whisper quiet enhancing the refinement around town or peaceful villages.
- EV** EV Off Mode: Enables the vehicle's default setting where the hybrid system selects the most efficient combination of diesel and electric power to meet the power and torque required.
- S** Sport Mode: Gives full access to the vehicle's performance, comparable to the SDV8. The throttle response becomes more immediate with torque triggered from less pedal pressure, ideal for when additional power is required.
- A** Auto Stop/Start: Increases charging opportunities as this option means the engine runs continuously, inhibiting the Stop/Start system.



Attention to detail is at the very heart of Land Rover. That's why even the alloy wheels on Range Rover Hybrid have been designed for increased efficiency. The design features spokes that are aerodynamically shaped so, as they move through the air, they require less power to keep them moving.

To finish, the vehicle is specified with a unique Hybrid badge that is located on the side vent.

STEP 1 CHOOSE YOUR ENGINE



DRIVELINE, ENGINE PERFORMANCE AND FUEL ECONOMY

The high performing range of petrol and diesel engines, along with the hybrid engine, uses the latest powertrain technology.

The intelligent Stop/Start** system on certain engines automatically shuts down the engine as soon as the vehicle comes to rest. The engine automatically starts again as soon as you lift your foot from the brake.

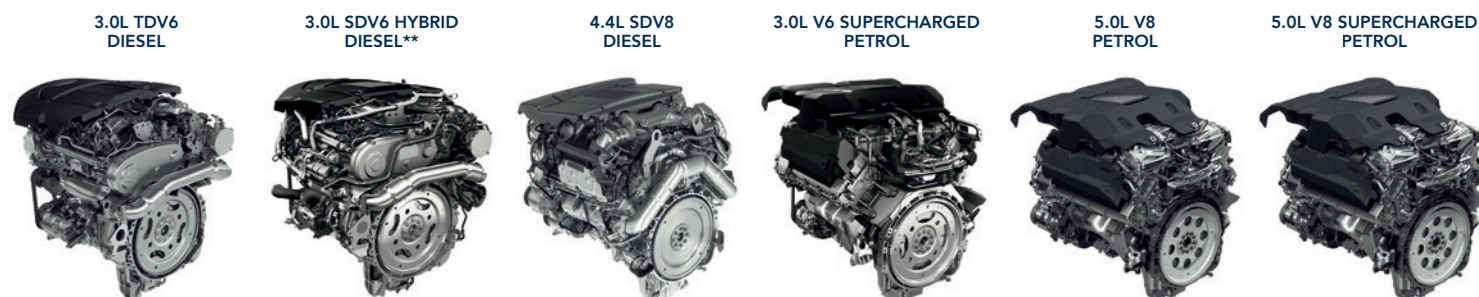

	3.0L TDV6 DIESEL	3.0L SDV6 HYBRID DIESEL	4.4L SDV8 DIESEL	3.0L V6 SUPERCHARGED PETROL	5.0L V8 PETROL	5.0L V8 SUPERCHARGED PETROL
Driveline	Four Wheel Drive (4WD)	Four Wheel Drive (4WD)	Four Wheel Drive (4WD)	Four Wheel Drive (4WD)	Four Wheel Drive (4WD)	Four Wheel Drive (4WD)
Power (kW / PS)	183 / 294	250 / 340	250 / 339	250 / 340	276 / 375	375 / 510
Torque (Nm)	600	700*	700	450	510	625
Maximum torque (rpm)	2,000	1,500-3,000*	1,750-2,300	3,500-5,000	3,500	2,500-5,500
Capacity (cc)	2,993	2,993	4,367	2,995	5,000	5,000
No. of cylinders	6	6	8	6	8	8
Cylinder layout	Longitudinal V6	Longitudinal V6	Longitudinal V8	Longitudinal V6	Longitudinal V8	Longitudinal V8

FUEL ECONOMY		3.0L TDV6 DIESEL	3.0L SDV6 HYBRID DIESEL	4.4L SDV8 DIESEL	3.0L V6 SUPERCHARGED PETROL	5.0L V8 PETROL	5.0L V8 SUPERCHARGED PETROL
Urban	l/100km (mpg)	8.5 (33.2) / 10.8 (26.2) [†]	6.7 (42.0)	11.5 (24.6)	14.3 (19.8) / 15.6 (18.1) [†]	18.0 (15.7)	18.3 (15.4) / 20.6 (13.7) [†]
Extra Urban	l/100km (mpg)	7.0 (40.4) / 7.5 (37.7) [†]	6.3 (45.0)	7.6 (37.2)	8.9 (31.7) / 9.1 (31.0) [†]	9.5 (29.7)	9.7 (29.1) / 9.9 (28.5) [†]
Combined	l/100km (mpg)	7.5 (37.7) / 8.6 (32.9) [†]	6.4 (44.1)	8.7 (32.5)	10.9 (25.9) / 11.5 (24.6) [†]	12.8 (22.1)	12.8 (22.1) / 13.8 (20.5) [†]
CO ₂ Urban emissions	g/km	224 / 285 [†]	177	306	333 / 364 ^{**†}	430	426 / 482 ^{**†}
CO ₂ Extra Urban emissions	g/km	187 / 200 [†]	165	203	208 / 212 ^{**†}	226	226 / 232 ^{**†}
CO ₂ Combined emissions	g/km	196 / 227 [†]	169	229	254 / 268 ^{**†}	299	299 / 322 ^{**†}

Availability of engines differs by market. Please contact your nearest Land Rover Dealer for more information. The figures provided are as a result of official manufacturer's tests in accordance with EU legislation. A vehicle's actual fuel consumption may differ from that achieved in such tests and these figures are for comparative purposes only. Low fuel warning at 9 litres approximately.

*When combined with electric motor.

**Not available in all markets.

[†]Without Intelligent Stop / Start technology.

Visit landrover.com for more information.

STEP 2 CHOOSE YOUR MODEL



MODELS BY ENGINE AND WHEELBASE

	HSE	VOGUE	VOGUE SE	AUTOBIOGRAPHY	AUTOBIOGRAPHY BLACK
ENGINE					
LR-TDV6 Diesel	■	■	■	■	■
LR-SDV6 Hybrid Diesel			■	■	■
LR-SDV8 Diesel		■	■	■	■
LR-V6 Supercharged Petrol	■	■	■	■	■
LR-V8 Petrol	■	■			
LR-V8 Supercharged Petrol		■	■	■	■
WHEELBASE					
Standard Wheelbase	■	■	■	■	■
Long Wheelbase		■	■	■	■

Availability of engines differs by market. Please contact your nearest Land Rover Dealer for more information.

Visit landrover.com for more information.

STEP 2 CHOOSE YOUR MODEL – CHOICES

Each model has a choice of engines and unique features. This guide will help you to select your ideal Range Rover. On the following pages you'll see the standard features for each model.

HSE*



- Grille in Dark Atlas
- Body coloured vent blades and door handles
- Front bumper accents in Atlas
- Seats in Grained leather.

VOGUE*



- Grille surround in Dark Atlas, grille mesh and ribs in Atlas
- Body coloured vent blades and door handles
- Front bumper accents in Atlas
- Seats in Oxford leather
- Santorini Black mirror caps on Long Wheelbase.

VOGUE SE*



- Grille surround in Dark Atlas, grille mesh and ribs in Atlas
- Vent blades and front bumper accents in Atlas
- Noble plated upper and lower door handles
- Seats in Semi-Aniline leather with contrast stitching
- Santorini Black mirror caps on Long Wheelbase.

AUTOBIOGRAPHY*



- Grille surround in Dark Atlas, mesh in Atlas and ribs in Bright Chrome
- Vent blades and front bumper accents in Atlas
- Noble plated upper and lower door handles
- Seats in Semi-Aniline leather with contrast stitching
- Santorini Black mirror caps on Long Wheelbase
- Autobiography badge on rear tailgate
- Autobiography lettering on treadplates
- Autobiography embossed script on centre rear squab
- Leather headlining and steering wheel
- Noble plated gear paddles.

AUTOBIOGRAPHY BLACK



- Unique front grille, grille surround in Santorini Black, grille surround inner in Bright Chrome, grille mesh with Bright Chrome inserts, inner grille mesh in Dark Atlas
- Vent blades in body colour with Bright Chrome inserts
- Side vent graphic with Bright Chrome inserts
- Body coloured mirror caps on Standard Wheelbase and Santorini Black mirror caps on Long Wheelbase
- Unique seat design and stitch pattern with perforated Semi-Aniline leather
- Leather perforated headlining
- Bright Chrome upper and lower door handles
- Chrome upper tailgate finisher
- Brushed stainless lower tailgate closure / finisher panel (between upper and lower tailgate)
- Unique Autobiography badge with Black enamel background and chrome text graphic
- Signature LED rear lamps
- Leather wrapped lower A, B and C pillars, loadspace sides, seat backs, ski hatch, parcel shelf and upper D pillar
- Enhanced rear seat centre console design with additional stowage
- Illuminated aluminium treadplates with unique Autobiography lettering
- Power deployable tables finished with Ebony leather.

STEP 3 CHOOSE YOUR COLOUR

Body and Roof Colour*

Yulong White
(Metallic)

Fuji White
(Solid)

Aleutian Silver
(Metallic)

Indus Silver
(Metallic)

Aruba
(Premium Metallic)

Scotia Grey
(Metallic)

Corris Grey
(Metallic)

Kaikoura Stone
(Metallic)

Causeway Grey
(Premium Metallic)

Firenze Red
(Metallic)



Optional Roof Colour

Contrast Indus Silver**



Contrast Santorini Black



Body and Roof Colour*

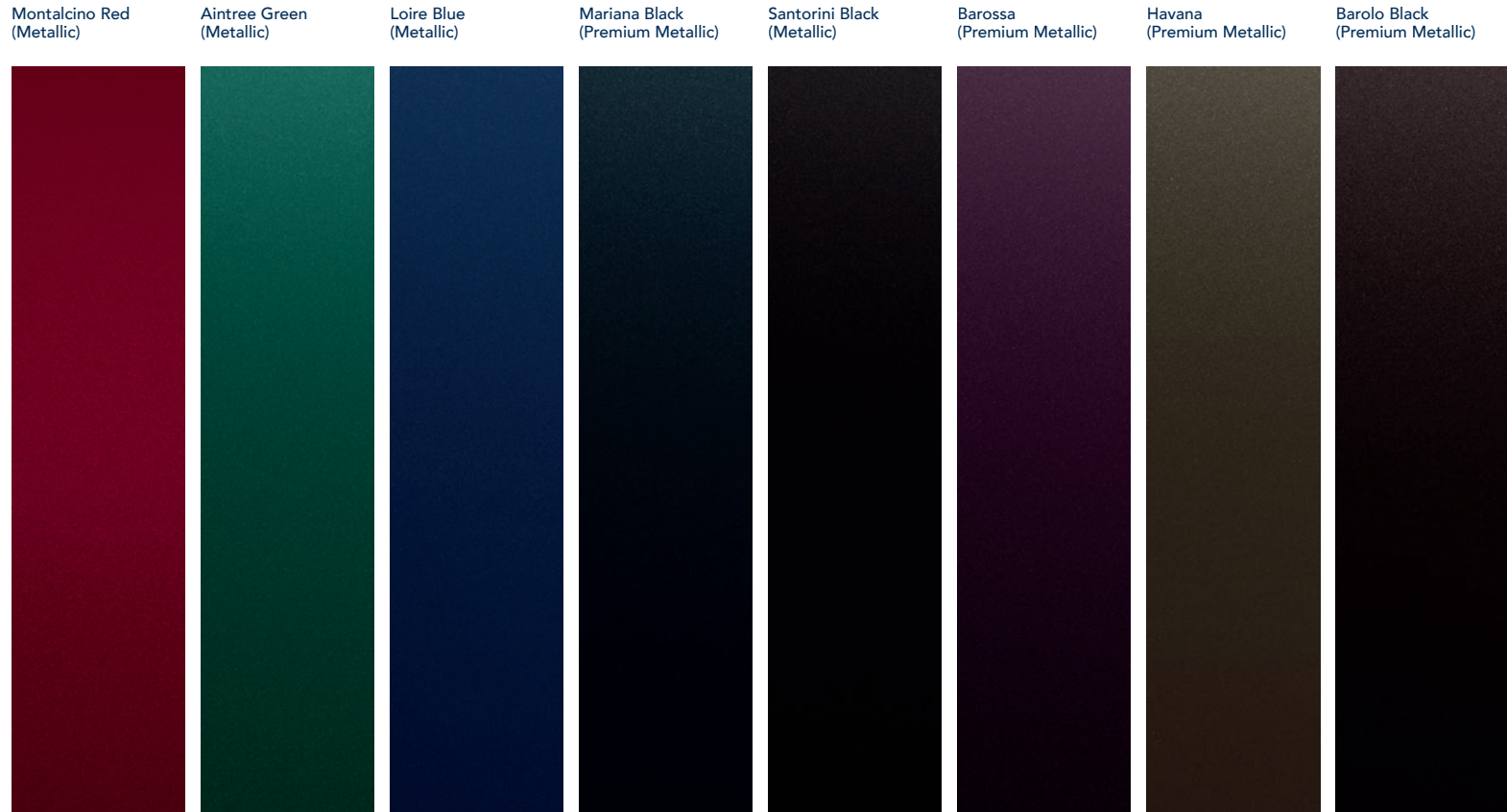

Optional Roof Colour

Contrast Indus Silver**



Contrast Santorini Black



*The availability of exterior paint colours varies by model and by time of year. Please contact your nearest Land Rover Dealer for further details.

**Not available with Dark Atlas Exterior Accent Packs.

For full details of colour options available on Autobiography and Autobiography Black models, please contact your nearest Land Rover Dealer.

Visit landrover.com for more information.

STEP 3 CHOOSE YOUR COLOUR – EXTERIOR ACCENT PACKS

Personalising the exterior

There is plenty of opportunity to tailor the exterior to suit your personal taste. In addition to the standard finish you can change the finish of the side vent graphic to Atlas or choose the Dark Atlas finish as part of an Exterior Accent Packs. These are also available as an accessory fitment. The Black Design Pack gives the overall design of the vehicle a more assertive appearance by changing individual elements to Gloss Black.

For more information contact your nearest Land Rover Dealer. Or use our online vehicle configurator at landrover.com

STANDARD FINISH (BASED ON VOGUE MODEL)*



- Grille surround in Dark Atlas, grille mesh and ribs in Atlas
- Body coloured vent blades and door handles
- Front bumper accents in Atlas
- Lower accent graphic in Atlas.

ATLAS SIDE VENT GRAPHIC**†



- Grille surround in Dark Atlas, grille mesh and ribs in Atlas
- Body coloured vent blades and door handles
- Front bumper accents in Atlas
- Lower accent graphic in Atlas
- Side vent graphic in Atlas.

*Model shown with optional 22 inch five split-spoke 'Style 504' alloy wheels.

**There are restrictions on exterior paint and roof colours with certain accent packs.

†Contrast roof in Indus Silver not available.

DARK ATLAS EXTERIOR ACCENT PACKS†



- Grille surround in Dark Atlas, grille mesh and ribs in Atlas
- Body coloured door handles
- Lower accent graphic in Dark Atlas
- Dark Atlas vent blades, front and rear bumper accents
- Optional Dark Atlas side vent graphic.

BLACK DESIGN PACK***



- Grille surround, mesh and ribs in Santorini Gloss Black
- Vent blades and front bumper finish in Santorini Gloss Black
- Lower accent graphic in Santorini Gloss Black
- Side vent graphic in Santorini Gloss Black
- Santorini Gloss Black upper mirror caps
- Tailgate finisher in Santorini Gloss Black
- Choice of two Black finish wheels – 21 inch and 22 inch, including black wheel nuts
- Range Rover script on bonnet and tailgate in Santorini Gloss Black.

STEP 4 CHOOSE YOUR WHEELS



19 INCH FIVE SPLIT-SPOKE
'STYLE 501'



19 INCH FIVE-SPLIT SPOKE
'STYLE 501'
WITH SATIN DARK GREY FINISH



20 INCH FIVE SPLIT-SPOKE
'STYLE 502'



20 INCH FIVE-SPLIT SPOKE
'STYLE 502'
WITH SHADOW CHROME FINISH



21 INCH TEN-SPOKE
'STYLE 101'
WITH DIAMOND TURNED FINISH



22 INCH FIVE SPLIT-SPOKE
'STYLE 504'



22 INCH SEVEN-SPLIT SPOKE
'STYLE 707'
WITH DIAMOND TURNED FINISH



22 INCH SEVEN-SPOKE
'STYLE 708'



21 INCH TEN-SPOKE
'STYLE 101'



21 INCH SIX-SPOKE
'STYLE 602'



21 INCH SIX-SPOKE
'STYLE 602'
WITH DIAMOND TURNED FINISH



21 INCH SEVEN-SPOKE
'STYLE 706'
WITH HIGH GLOSS POLISHED FINISH



21 INCH NINE-SPOKE
'STYLE 901'
WITH GLOSS BLACK FINISH



22 INCH SEVEN-SPLIT SPOKE
'STYLE 707'
WITH GLOSS BLACK FINISH



22 INCH SIX-SPOKE
'STYLE 601'
WITH DIAMOND TURNED FINISH



22 INCH SEVEN-SPOKE
'STYLE 706'
WITH HIGH GLOSS POLISHED FINISH

STEP 5 CHOOSE YOUR INTERIOR



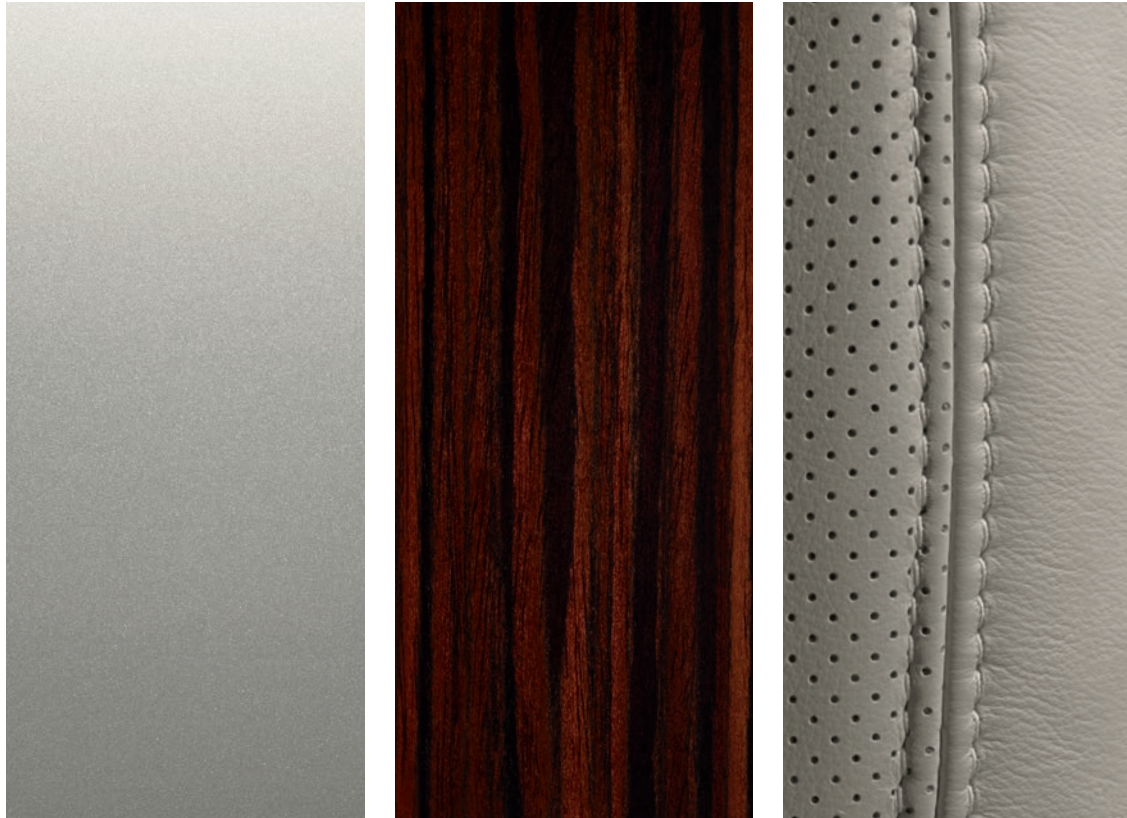

The Range Rover defines modern living. The strong architectural lines of the interior are balanced by soft lighting and the extensive choice of colourways available. The fit and finish, including the judicious use of leather and wood, truly complements the luxurious styling.

STEP 5 CHOOSE YOUR INTERIOR – LEATHER FINISHES



Beautiful materials, flawless execution

The interior is upholstered in the finest natural materials including lavish wood veneers, immaculate metal finishes and premium leathers. Beautifully soft, and with tailored hand-stitching, the type of leather is determined by model choice. It enhances the cabin, covering virtually every surface from the seats and instrument panel to the doors and headlining. The Range Rover Vogue SE, Autobiography and Autobiography Black feature Semi-Aniline leather with high-grade hides hand-picked for their exceptional suppleness and natural appearance.

STEP 5 CHOOSE YOUR INTERIOR – TRIM FINISHER CHOICES



SHADOW WALNUT
WOOD VENEER



FIGURED MACASSAR
WOOD VENEER

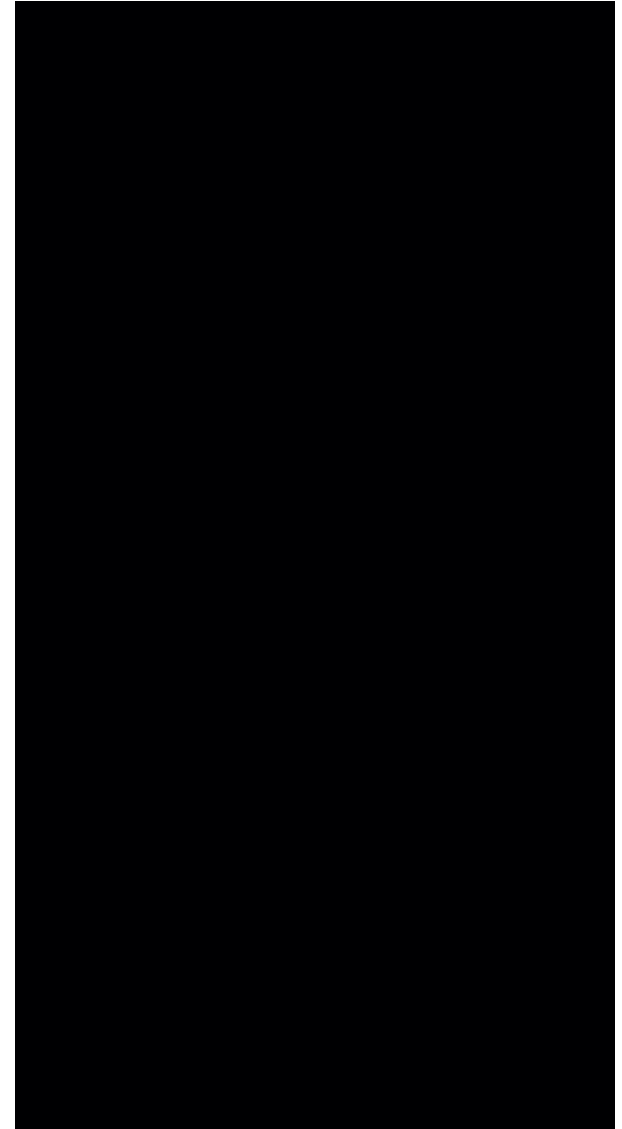

GRAND BLACK
WOOD VENEER

STEP 5 CHOOSE YOUR INTERIOR – INTERIOR SEAT OPTIONS



Bench seat

Standard on all models, the leather bench seat can accommodate up to three passengers and is available with manual or power recline.

The centre seat folds flat to reveal the rear seat cupholders.

For extended load capacity all of the rear seats will fold flat. Additionally this can be operated electronically by the touch of a button in the loadspace for seats specified with power recline.

Available on Standard Wheelbase and Long Wheelbase variants. Not available on Autobiography Black.



Interior shown is Autobiography

Rear Executive Class seats















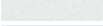

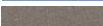
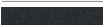

For the ultimate in rear seat luxury, the Rear Executive Class seating option provides supreme comfort and convenience, with two individual rear seats and the full extended centre console finished in the finest veneer. Seat functionality includes memory, power recline and a three-mode massage feature.

The option of a Long Wheelbase adds 186mm in the second row of seats and has the additional benefit of providing rear passengers with a recline of some 17 degrees.

Note however, these seats do not fold.

Available on Range Rover Vogue SE, Autobiography and standard on Autobiography Black models. Also available on both Standard Wheelbase and Long Wheelbase variants.

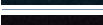
STEP 5 CHOOSE YOUR INTERIOR - COLOUR AND TRIM MATRIX

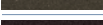
COLOURWAYS		EBONY/ EBONY (page 53)		ESPRESSO/ALMOND (page 54)		EBONY/CIRRUS (page 55)		ESPRESSO/IVORY (page 56)		EBONY/IVORY (page 57)		NAVY/CIRRUS (page 58)		EBONY/TAN (page 59)	
INTERIOR COLOUR															
Seat colour		Ebony		Almond Espresso		Cirrus Ebony		Ivory Espresso		Ivory Ebony		Cirrus Navy		Tan	
Carpet		Ebony		Almond		Ebony		Espresso		Ebony		Navy		Ebony	
MODEL															
HSE (Grained leather)		○		○ –		○ –		– –		– –		– –		–	
Vogue (Oxford leather)		○		○ ○		○ ○		○ ○		○ ○		– –		–	
Vogue SE (Semi-Aniline leather)		○		○ ○		○ ○		○ ○		○ ○		○ ○		–	
Autobiography (Semi-Aniline leather)		○		○ ○		○ ○		○ ○		○ ○		○ ○		○	
Autobiography Black (Perforated Semi-Aniline leather)		–		– –		– –		– –		– –		– –		–	
WOOD VENEER															
 Grand Black		○		– –		▲ ▲		– –		○ ○		– –		▲	
 Figured Macassar		○		▲ ▲		○ ○		▲ ▲		○ ○		○ ○		▲	
 Shadow Walnut		○		○ ○		○ ○		▲ ▲		○ ○		○ ○		○	
EXTERIOR COLOUR*															
 Yulong White		○		○ ○		▲ ▲		○ ○		○ ○		▲ ▲		○	
 Fuji White		○		○ ○		○ ○		○ ○		○ ○		○ ▲		▲	
 Aleutian Silver		○		○ ○		▲ ○		○ ○		○ ○		▲ ▲		○	
 Indus Silver		▲		○ ○		▲ ○		○ ○		○ ○		○ ▲		○	
 Aruba		○		○ ○		○ ○		▲ ▲		▲ ○		○ ○		○	
 Scotia Grey		○		○ ○		○ ○		○ ○		○ ○		○ ○		○	
 Corris Grey		▲		○ ○		▲ ○		○ ○		○ ○		○ ○		○	
 Kaikoura Stone		○		○ ▲		○ ○		○ ▲		○ ○		○ ○		○	
 Causeway Grey		▲		○ ○		▲ ○		○ ○		▲ ○		○ ○		▲	
 Firenze Red		○		○ ○		○ ○		○ ○		○ ▲		○ ○		–	
 Montalcino Red		○		○ ○		○ ○		○ ○		○ ○		○ ○		–	
 Aintree Green		○		○ ○		○ ○		▲ ○		○ ○		– –		○	
 Loire Blue		○		○ ○		○ ○		○ ○		▲ ○		○ ▲		○	
 Mariana Black		○		○ ○		○ ○		○ ○		▲ ○		▲ ▲		○	
 Santorini Black		○		○ ○		▲ ○		○ ○		○ ▲		○ ○		▲	
 Barossa		○		○ ○		○ ○		○ ○		○ ○		○ ○		○	
 Havana		○		▲ ○		○ ○		▲ ○		○ ○		○ ○		○	
 Barolo Black		○		○ ○		○ ○		▲ ○		○ ○		○ ○		▲	

Exclusive to Autobiography Black

COLOURWAYS		BROGUE/IVORY (page 60)		DARK CHERRY/IVORY (page 61)		EBONY/PIMENTO (page 62)	DARK CHERRY/ IVORY** (page 63)	ESPRESSO/TAN (page 64)	EBONY/LUNAR (page 65)	LUNAR/CIRRUS (page 66)	NAVY/IVORY† (page 67)
INTERIOR COLOUR											
Seat colour		Ivory	Brogue	Ivory	Dark Cherry	Pimento	Dark Cherry/Ivory	Tan	Ebony	Cirrus	Ivory
Carpet		Espresso		Dark Cherry		Ebony	Dark Cherry	Espresso	Lunar	Lunar	Navy
MODEL											
HSE (Grained leather)		-	-	-	-	-	-	-	-	-	-
Vogue (Oxford leather)		-	-	-	-	-	-	-	-	-	-
Vogue SE (Semi-Aniline leather)		-	-	-	-	-	-	-	-	-	-
Autobiography (Semi-Aniline leather)		o	o	o	o	o	-	-	-	-	-
Autobiography Black (Perforated Semi-Aniline leather)		-	-	-	-	-	o	o	o	o	o
WOOD VENEER											
Grand Black		-	-	o	o	▲	-	-	▲	o	-
Figured Macassar		▲	▲	▲	▲	o	▲	▲	o	o	▲
Shadow Walnut		▲	▲	o	o	o	▲	▲	o	-	▲
EXTERIOR COLOUR*											
Yulong White		o	o	o	o	o	o	o	o	▲	o
Fuji White		o	o	o	o	o	o	o	o	▲	o
Aleutian Silver		o	o	o	o	o	o	o	o	▲	▲
Indus Silver		o	o	o	o	o	o	o	o	▲	o
Aruba		o	▲	▲	o	o	▲	o	o	o	o
Scotia Grey		o	o	o	o	o	o	o	o	o	o
Corris Grey		o	o	o	o	o	o	o	▲	▲	o
Kaikora Stone		o	▲	o	o	o	o	▲	o	o	o
Causeway Grey		o	o	o	o	o	o	▲	▲	▲	o
Firenze Red		o	o	o	o	o	o	-	o	o	o
Montalcino Red		o	o	▲	▲	▲	▲	-	o	o	o
Aintree Green		o	o	-	-	o	-	o	o	o	-
Loire Blue		o	o	o	o	o	o	o	o	o	▲
Mariana Black		o	o	o	o	o	o	o	o	o	▲
Santorini Black		o	o	o	o	o	o	o	▲	o	o
Barossa		o	o	▲	▲	o	▲	o	o	o	o
Havana		o	o	o	o	o	o	o	o	o	o
Barolo Black		o	o	o	o	o	o	▲	o	o	o

▲ Combination is Designer's Choice o Combination is Available - Not Available.

*The availability of exterior paint colours varies by model and by time of year. Please contact your nearest Land Rover Dealer for further details.

**Dark Cherry/Ivory seat in duo-tone. †Only available in Poltrona Frau seat pattern.

For full details of colour options available on Autobiography and Autobiography Black models, please contact your nearest Land Rover Dealer for further details.

STEP 5 CHOOSE YOUR INTERIOR – CHOICES

Interior colour choices

Each interior comes in a combination of two colours – the primary colour and a complementary secondary colour. You can further personalise your interior colour selections with a choice of wood veneers. If you choose the Vogue, Vogue SE or Autobiography models you can also specify the colour of your seat*.



COLOURWAYS	① INSTRUMENT PANEL UPPER	② INSTRUMENT PANEL LOWER	③ DOOR AND ARMREST UPPER	④ DOOR LOWER	⑤ CUBBY BOX**
Ebony/Ebony	Ebony	Ebony	Ebony	Ebony	Ebony
Espresso/Almond	Espresso	Almond	Almond	Espresso	Espresso/Almond
Ebony/Cirrus	Ebony	Cirrus	Cirrus	Ebony	Ebony/Cirrus
Espresso/Ivory	Espresso	Ivory	Ivory	Espresso	Espresso/Ivory
Ebony/Ivory	Ebony	Ivory	Ivory	Ebony	Ebony/Ivory
Navy/Cirrus	Navy	Cirrus	Cirrus	Navy	Navy/Cirrus
Ebony/Tan	Ebony	Tan	Tan	Ebony	Tan
Brogue/Ivory	Brogue	Ivory	Ivory	Brogue	Brogue/Ivory
Dark Cherry/Ivory	Dark Cherry	Ivory	Ivory	Dark Cherry	Dark Cherry/Ivory
Ebony/Pimento	Ebony	Pimento	Pimento	Ebony	Pimento
EXCLUSIVE TO AUTOBIOGRAPHY BLACK					
Dark Cherry/Ivory	Dark Cherry	Ivory	Ivory	Dark Cherry	Ivory
Espresso/Tan	Espresso	Tan	Tan	Espresso	Tan
Ebony/Lunar	Ebony	Lunar	Lunar	Lunar	Ebony
Lunar/Cirrus	Lunar	Cirrus	Cirrus	Lunar	Cirrus
Navy/Ivory	Navy	Ivory	Ivory	Navy	Ivory

*Not available on all colourways. Please refer to page 50 and 51 for specific colourway options.

**Cubby Box colour matches seat colour chosen.

Ebony / Ebony (available on HSE, Vogue, Vogue SE and Autobiography)



Interior shown:
Ebony/Ebony, with Ebony seats
and Grand Black Wood Veneer.

Seat



Ebony

Wood Veneer



Grand Black Wood Veneer



Figured Macassar Wood Veneer



Shadow Walnut Wood Veneer

This interior is available in Grained leather on HSE models, Oxford leather on Vogue models and Semi-Aniline leather on Vogue SE and Autobiography models. For specific colourway options please refer to page 50.

Headlining is available in Ebony or Cirrus.

STEP 5 CHOOSE YOUR INTERIOR – CHOICES

Espresso / Almond (available on HSE, Vogue, Vogue SE and Autobiography)

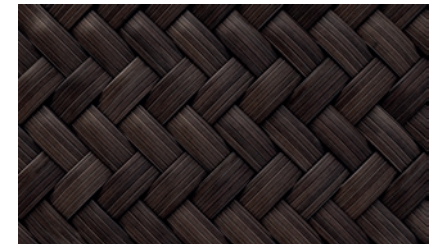

Interior shown:
Espresso/Almond, with Almond
seats and Shadow Walnut
Wood Veneer.

Seat



Almond

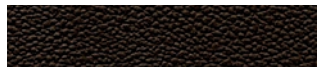

Espresso*

Wood Veneer



Shadow Walnut Wood Veneer



Figured Macassar Wood Veneer

This interior is available in Grained leather on HSE models, Oxford leather on Vogue models and Semi-Aniline leather on Vogue SE and Autobiography models. For specific colourway options please refer to page 50.

Headlining is available in Ivory.

Ebony / Cirrus (available on HSE, Vogue, Vogue SE and Autobiography)



Interior shown:
Ebony/Cirrus, with Cirrus seats
and Grand Black Wood Veneer.

Seat



Cirrus



Ebony*

Wood Veneer



Grand Black Wood Veneer



Figured Macassar Wood Veneer

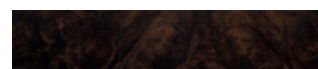

Shadow Walnut Wood Veneer

This interior is available in Grained leather on HSE models, Oxford leather on Vogue models and Semi-Aniline leather on Vogue SE and Autobiography models. For specific colourway options please refer to page 50.

Headlining is available in Ebony or Cirrus.

*Not available on HSE.

STEP 5 CHOOSE YOUR INTERIOR – CHOICES

Espresso / Ivory (available on Vogue, Vogue SE and Autobiography)



Interior shown:
Espresso/Ivory, with Espresso
seats and Figured Macassar
Wood Veneer.

Seat

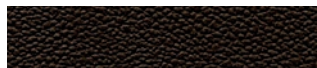

Espresso

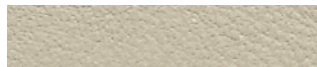

Ivory

Wood Veneer



Figured Macassar Wood Veneer



Shadow Walnut Wood Veneer

This interior is available in Oxford leather on Vogue models and Semi-Aniline leather on Vogue SE and Autobiography models. For specific colourway options please refer to page 50.
Headlining is available in Ivory.

Ebony / Ivory (available on Vogue, Vogue SE and Autobiography)



Interior shown:
Ebony/Ivory, with Ivory seats
and Grand Black Wood Veneer.

Seat



Ivory



Ebony

Wood Veneer



Grand Black Wood Veneer



Figured Macassar Wood Veneer



Shadow Walnut Wood Veneer

This interior is available in Oxford leather on Vogue models and Semi-Aniline leather on Vogue SE and Autobiography models. For specific colourway options please refer to page 50.

Headlining is available in Ebony or Ivory.

STEP 5 CHOOSE YOUR INTERIOR – CHOICES

Navy / Cirrus (available on Vogue SE and Autobiography)



Interior shown:
Navy/Cirrus, with Navy seats
and Shadow Walnut Wood Veneer.

Seat



Navy



Cirrus

Wood Veneer



Shadow Walnut Wood Veneer



Figured Macassar Wood Veneer

This interior is available in Semi-Aniline leather on Vogue SE and Autobiography models. For specific colourway options please refer to page 50.

Headlining is available in Cirrus.

Ebony / Tan (available on Autobiography)



Interior shown:
Ebony/Tan, with Tan seats
and Figured Macassar
Wood Veneer.

Seat



Tan

Wood Veneer

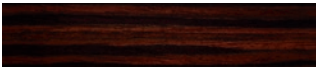

Figured Macassar Wood Veneer



Grand Black Wood Veneer



Shadow Walnut Wood Veneer

This interior is available as part of the Extended Interior Trim Palette in Semi-Aniline leather on Autobiography. For specific colourway options please refer to page 50. Headlining is available in Ebony or Ivory.

STEP 5 CHOOSE YOUR INTERIOR – CHOICES

Brogue / Ivory (available on Autobiography)



Interior shown:
Brogue/Ivory, with Brogue
seats and Figured Macassar
Wood Veneer.

Seat



Brogue



Ivory

Wood Veneer



Figured Macassar Wood Veneer



Shadow Walnut Wood Veneer

This interior is available as part of the Extended Interior Trim Palette in Semi-Aniline leather on Autobiography. For specific colourway options please refer to page 51. Headlining is available in Ivory.

Dark Cherry / Ivory (available on Autobiography)

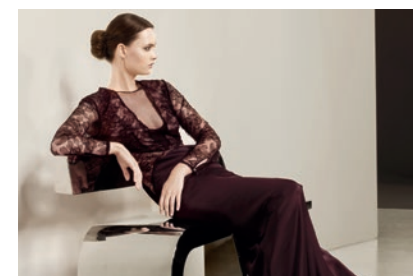

Interior shown:
Dark Cherry/Ivory, with Ivory
seats and Figured Macassar
Wood Veneer.

Seat



Ivory

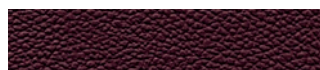

Dark Cherry

Wood Veneer



Figured Macassar Wood Veneer



Grand Black Wood Veneer



Shadow Walnut Wood Veneer

This interior is available as part of the Extended Interior Trim Palette in Semi-Aniline leather on Autobiography. For specific colourway options please refer to page 51. Headlining is available in Ivory.

STEP 5 CHOOSE YOUR INTERIOR – CHOICES

Ebony / Pimento (available on Autobiography)



Interior shown:
Ebony/Pimento, with Pimento seats
and Grand Black Wood Veneer.

Seat



Pimento

Wood Veneer



Grand Black Wood Veneer



Figured Macassar Wood Veneer



Shadow Walnut Wood Veneer

This interior is available as part of the Extended Interior Trim Palette in Semi-Aniline leather on Autobiography. For specific colourway options please refer to page 51.

Headlining is available in Ebony or Ivory.

Dark Cherry / Ivory (available on Autobiography Black)

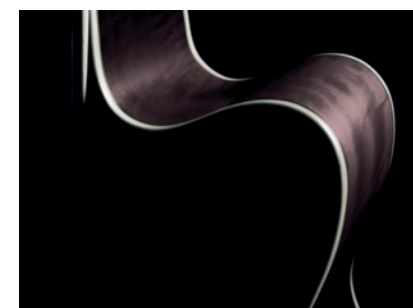
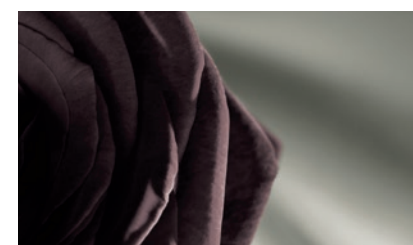
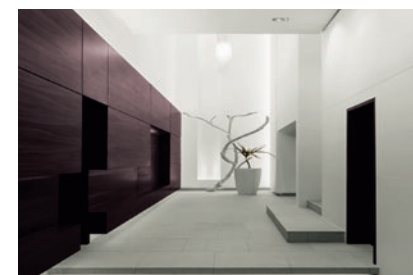

Interior shown:
Dark Cherry/Ivory, with Dark
Cherry/Ivory duo-tone seats and
Figured Macassar Wood Veneer.

Seat

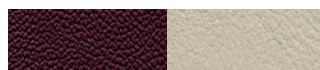

Dark Cherry/Ivory (Duo-tone)

Wood Veneer



Figured Macassar Wood Veneer



Shadow Walnut Wood Veneer

This unique interior is available as part of the Autobiography Black Interior Trim Palette in Perforated Semi-Aniline leather. For specific colourway options please refer to page 51. Headlining is available in Ivory.

STEP 5 CHOOSE YOUR INTERIOR – CHOICES

Espresso / Tan (available on Autobiography Black)

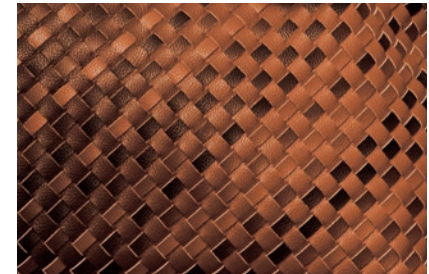

Interior shown:
Espresso/Tan, with Tan seats and
Figured Macassar Wood Veneer.

Seat



Tan

Wood Veneer



Figured Macassar Wood Veneer



Shadow Walnut Wood Veneer

This unique interior is available as part of the Autobiography Black Interior Trim Palette in Perforated Semi-Aniline leather. For specific colourway options please refer to page 51. Headlining is available in Ivory.

Ebony / Lunar (available on Autobiography Black)



Interior shown:
Ebony/Lunar, with Ebony seats and
Grand Black Wood Veneer.

Seat



Ebony

Wood Veneer



Grand Black Wood Veneer



Figured Macassar Wood Veneer



Shadow Walnut Wood Veneer

This unique interior is available as part of the Autobiography Black Interior Trim Palette in Perforated Semi-Aniline leather on Autobiography Black. For specific colourway options please refer to page 51.

Headlining is available in Ebony or Cirrus.

STEP 5 CHOOSE YOUR INTERIOR – CHOICES

Lunar / Cirrus (available on Autobiography Black)



Interior shown:
Lunar/Cirrus, with Cirrus seats and
Grand Black Wood Veneer.

Seat



Cirrus

Wood Veneer



Grand Black Wood Veneer



Figured Macassar Wood Veneer

This unique interior is available as part of the Autobiography Black Interior Trim Palette in Perforated Semi-Aniline leather on Autobiography Black. For specific colourway options please refer to page 51.

Headlining is available in Cirrus.

Navy / Ivory (available on Autobiography Black)



Interior shown:
Navy/Ivory, with Ivory Poltrona Frau
seat pattern and Shadow Walnut
Wood Veneer.

Seat



Ivory Poltrona Frau seat pattern

Wood Veneer



Figured Macassar Wood Veneer



Shadow Walnut Wood Veneer

This unique interior is available as part of the
Extended Interior Trim Palette in Semi-Aniline leather
on Autobiography Black. For specific colourway
options please refer to page 51.
Headlining is available in Ivory.

KEY FEATURES

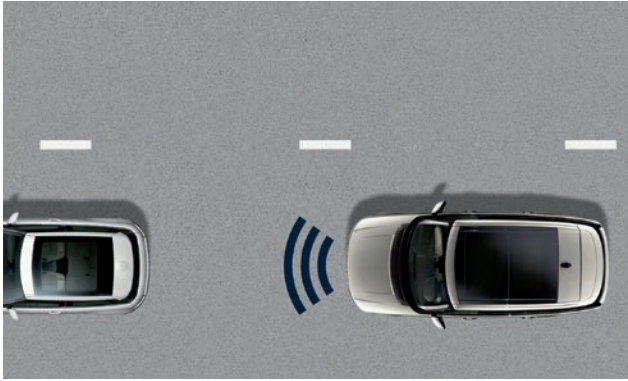

Adaptive Cruise Control with Queue Assist

Adaptive Cruise Control (ACC) is an optional system that helps maintain a pre-set gap from the vehicle in front, even if it changes speed.

Queue Assist extends the ACC functionality. It is designed to allow the vehicle to come to a stop when it reaches a traffic queue.

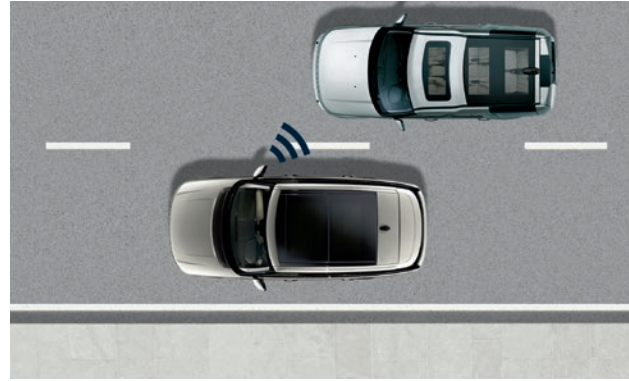

Blind Spot Monitor and Closing Vehicle Sensing

Using sensors mounted on the sides and the rear bumper, these optional systems are designed to see what you might miss. When a vehicle enters a blind spot, a warning light will show in the corresponding door mirror.

Closing Vehicle Sensing scans a zone much further behind the vehicle, to help detect vehicles which are closing quickly from behind, and which could cause a threat during a lane change manoeuvre.

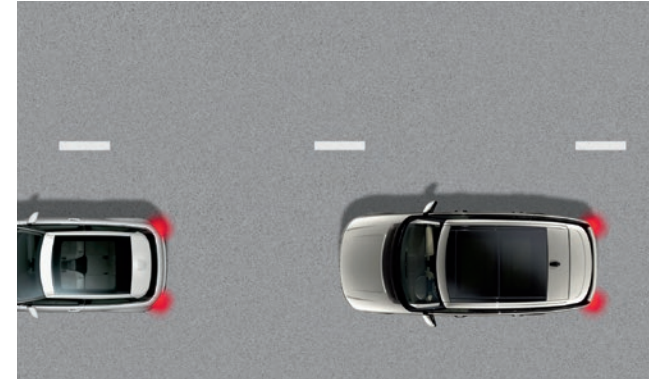

Safety

With driver and passenger airbags, side curtain and thorax airbags and active front seat belts linked to the vehicle's emergency braking functions, safety for all occupants is optimised.

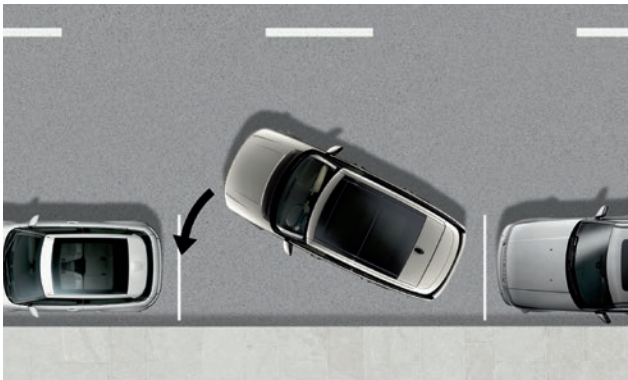

Parallel Park

Using sensors, optional Parallel Park identifies parking spaces and helps you parallel park in tight spots. The screen prompts you to select reverse and then automatically steers you into place. You stay in control using the brake and graphics guide you through each manoeuvre.



Reverse Traffic Detection

Using radar detectors in the rear of the vehicle this optional system is designed to warn you about potential collisions during reversing manoeuvres. The system can help detect a vehicle approaching from either side. When a target vehicle with a credible 'time to collision' is detected (a collision within three seconds or less), the system alerts the driver. Three warnings are given: an indicator lights up in the corresponding door mirror, an audible alert is sounded and a warning symbol is displayed on the camera screen. This feature is standard on Autobiography Black.



360° Park Distance Control

With virtual object tracking along the sides of the car, 360° Park Distance Control gives confidence in confined situations, like multi-storey car parks at speeds up to 16kph. This is an optional feature.



Wade Sensing™

The optional wade sensing feature assists the driver when crossing streams, fords and flooded roads, by using sensors in the wing mirrors and alerting the driver if the water is too deep.

This feature provides real-time pictorial wading information, including the depth of the water in relation to the vehicle, as well as maximum wading capability of the vehicle via the Touch-screen. This feature is standard on Autobiography Black.



Interior Mood Lighting

The clean, elegant lines and premium materials of the interior are enhanced by carefully detailed LED mood lighting that brings the cabin alive at night. Following the lines of the veneer surface of the centre console, the lighting offers ten colours which can be chosen to suit your taste and mood.



Seat Comfort

The massage seats feature five programmes and are available for driver and passenger. Both front and rear seats have winged headrests and rear seat recline is standard on all vehicles.

Driver and Front Passenger Upper Seat Articulation is a new feature that allows the driver and front passenger to adjust the upper part of their seats, providing an extra level of comfort and functionality.



Audio

The Meridian™ audio technology gives you stunning sound quality. The top of the range system features Meridian Signature Reference Audio with 29 speakers including subwoofer, and 3D surround sound.



Surround Camera System

For a complete, all-round view, the latest surround camera system incorporating T-Junction view helps you see everything clearly on the full-colour Touch-screen. This system will also help you with towing as it includes trailer reverse park guidance and trailer hitch guidance. This feature is optional on HSE.



Dual View Touch-Screen

Dual View technology enables driver and front passenger to view completely independent display content via the Touch-screen, so the passenger can watch TV while the driver follows navigational instructions.

KEY FEATURES



Powered Tailgate

The characteristic Range Rover split tailgate is fully power operated. The upper tailgate can be opened remotely from the key fob or via a switch on the dash, or both gates can be independently operated using buttons on the tailgate, the key fob or from the driver's seat. To help prevent accidents the power operation will stop when it detects an obstruction. Optional on HSE.



Terrain Response® 2

Next generation Terrain Response® 2 is designed to monitor driving conditions and automatically optimises the vehicle's settings to suit the terrain giving you the ultimate in ride comfort on all surfaces including grass/gravel/snow, mud/ruts, sand and rock. And even if it is not in auto mode, it will let you know if you should select low range and off-road ride height. This feature is standard on Autobiography and Autobiography Black.



Climate Control and Park Heat

Three-zone climate control includes separate controls for driver, front passenger and rear seats. The optional four-zone climate control helps give more control to rear passengers. Remote Park Heat with Timed Climate enables you to pre-heat or cool the vehicle with remote control and seven-day timer.



Adaptive Dynamics

Standard on all vehicles, Adaptive Dynamics monitors the vehicle's movements at least 500 times a second, reacting to driver or road inputs virtually instantaneously, helping to give greater control and minimising body roll, for a composed ride. The system even senses off-road conditions, and optimises damping accordingly.



Rear Seat Entertainment System with 10.2 inch Screen

The optional Rear Seat Entertainment System provides big-screen entertainment for rear passengers, offering twin remote 10.2 inch rear seat mounted screens, a pair of WhiteFire® digital wireless headphones and a USB connector. It also includes 'Journey Status', a Navigation Summary screen which displays a pop-up for the rear occupant detailing the time and distance to destination. (Image shown is Long Wheelbase vehicle).



Rear Executive Class Seating

Choose the Range Rover Autobiography Black, Autobiography or Hybrid and you can select Rear Executive Class seating. The ultimate in comfort, these two individual seats feature memory, powered headrest, rear centre console armrest, cushion adjustments, massage seats and power recline. The individual seats are divided by an elegant console that houses the controls and an optional cool box.



InControl™ Apps

Land Rover InControl™ Apps enables you to use vehicle optimised smartphone apps on the vehicles touch-screen. Using the InControl Apps USB port you can enjoy a variety of vehicle optimised apps such as: Contacts, Calendar and Music Player, with more third party vehicle optimised apps being released over time. Your smartphone will also be re-charged whilst using InControl Apps.



Land Rover InControl™ Wi-Fi*

Land Rover InControl™ Wi-Fi provides in-car access to a 3G hotspot enabling up to eight devices to be used simultaneously; allowing passengers to work or be entertained throughout the journey.

Note: Land Rover InControl™ Wi-Fi and Land Rover InControl™ Secure cannot be fitted to the same vehicle. InControl Wi-Fi requires the owner to use an additional SIM card which can be obtained from their mobile phone service provider.



Land Rover InControl™ Remote

Make life a little easier with the Smartphone App. Check your fuel levels remotely, find your car in a busy car park, save your journey information and check if you have left doors or windows open. SOS Emergency Call and Optimised Land Rover Assistance use GPS technology to minimise delay in getting assistance to your exact location.



Land Rover InControl™ Secure one year Package*

Land Rover InControl™ Secure uses tracking technology to alert you of an attempted theft and signals your vehicle's location to the Land Rover tracking centre to aid swift recovery.

Please note: Land Rover InControl™ Wi-Fi and Land Rover InControl™ Secure cannot be fitted to the same vehicle.

*Mobile network connectivity cannot be guaranteed in all locations.

DIMENSIONS AND CAPABILITIES



Standard Wheelbase (SWB) 2,922mm



Height
SWB 1,835mm
LWB 1,840mm



Front wheel track 1,690mm



Rear wheel track 1,683mm

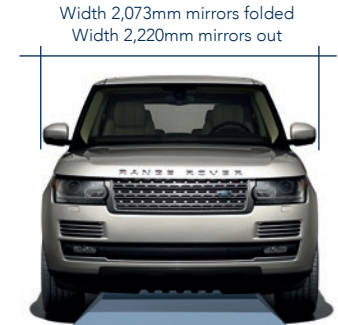

Width 2,073mm mirrors folded
Width 2,220mm mirrors out

Obstacle Clearance

Off-road height 296.1mm
Standard ride height 221.1mm



Long Wheelbase (LWB) 3,120mm

Standard Overall length 4,999mm (Long Wheelbase 5,199mm)



Turning Circle

Kerb-to-kerb 12.3m (Long Wheelbase 13.0m)
Wall-to-wall 12.7m (Long Wheelbase 13.4m)
Turns lock-to-lock 3.03

Standard Ride Height

With roof rails 1,836mm (LWB 1,840mm)
With panoramic roof open 1,874mm (LWB 1,880mm)
With Telematics roof antenna 1,860mm (LWB 1,866mm)
Access height air suspension setting will reduce each of the above by 50mm

Loadspace Capacity

Rear seats upright
Height 824mm, Width 1,290mm
Loadspace volume 909 litres
Loadspace width between arches 1,120mm
Length at floor 1,101mm

Rear seats forward
Height 824mm, Width 1,290mm
Loadspace volume 2,030 litres (LWB 2,345 litres)
Loadspace width between arches 1,120mm
Length at floor 1,985mm (LWB 2,177 mm)

Headroom

Maximum front headroom with panoramic roof 997mm
Rear headroom 996mm (LWB 973mm)

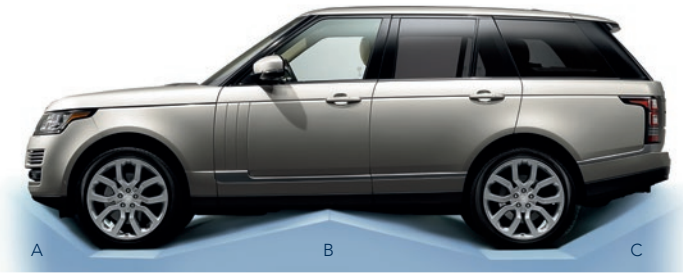

	A	B	B	C
Ride Height	Approach Angle	Ramp Angle	Ramp Angle (Hybrid)	Departure Angle
Off-road SWB / LWB	34.7	28.3 / 26.1	27.3 / 25.1	29.6
Standard SWB / LWB	26	20.1 / 18.4	19.6 / 17.9	24.6



Wading Depth

Maximum wading depth 900mm

Please note: Figures related to both Standard (SWB) and Long Wheelbase (LWB) models unless stated.

TECHNICAL SPECIFICATION / PERFORMANCE AND KEY DATA

	TDV6 190KW	SDV6 250KW HYBRID	SDV8 250KW	V6 SUPERCHARGED 250KW	V8 276KW	V8 SUPERCHARGED 375KW
ENGINE DATA						
Capacity (cc)	2,993	2,993	4,367	2,995	5,000	5,000
No. of cylinders	6	6	8	6	8	8
Cylinder layout	Longitudinal V6	Longitudinal V6	Longitudinal V8	Longitudinal V6	Longitudinal V8	Longitudinal V8
Valves per cylinder	4	4	4	4	4	4
Bore (mm)	84	84	84	84.5	92.5	92.5
Stroke (mm)	90	90	98.5	89	93	93
Compression ratio (:1)	16.1	16.1	16.1	10.5	11.5	9.5
Maximum power kW (PS) / rpm	183 (294) / 4,000	250 (340) / 4,000**	250 (339) / 3,500	250 (340) / 6,500	276 (375) / 6,500	375 (510) / 6,000-6,500
Maximum torque Nm / rpm	600 / 2,000	700 / 1,500-3,000**	700 / 1,750-2,300	450 / 3,500-5,000	510 / 3,500	625 / 2,500-5,500
BRAKES						
Front type	Ventilated disc	Ventilated disc	Ventilated disc	Ventilated disc	Ventilated disc	Ventilated disc
Front diameter (mm)	350	380	380	350	350	380
Rear type	Ventilated disc	Ventilated disc	Ventilated disc	Ventilated disc	Ventilated disc	Ventilated disc
Rear diameter (mm)	350	365	365	350	350	365
Park Brake	Electric Park Brake (EPB) integrated into brake caliper					
WEIGHTS (kg)						
Weight from (LWB)	2,160 (2,301)	2,394	2,410 (2,488)	2,222 (2,372)	2,198	2,330 (2,413)
Maximum laden weight (LWB)	3,000 (3,050)	3,100	3,200	3,050 (3,100)	3,000	3,150
Maximum mass on each axle (front)	1,500	1,550	1,550	1,500	1,500	1,550
Maximum mass on each axle (rear)	1,775	1,775	1,775	1,775	1,775	1,775
TOWING (kg)						
Unbraked trailer	750	750	750	750	750	750
Maximum towing	3,500	3,000	3,500	3,500	3,500	3,500
Maximum coupling point / nose weight	150	120	150	150	150	150
Maximum vehicle and trailer combination / Gross Train Weight	6,500	6,100	6,700	6,500	6,500	6,650
ROOF CARRYING (kg)						
Maximum roof load (including Roof Rails)	100	100	100	100	100	100
PERFORMANCE AND FUEL ECONOMY						
Maximum speed kph (mph)	210 (130)	218 (135)	218 (135)	210 (130)	210 (130)	225 / 250* (140 / 155*)
Acceleration (secs) 0-100kph (LWB)	7.9 (8.3)	6.9	6.9 (7.2)	7.4 (7.8)	6.8	5.4 (5.8)
Acceleration (secs) 0-60mph (LWB)	7.4 (7.8)	6.5	6.5 (6.6)	7.1 (7.4)	6.5	5.1 (5.5)
Fuel tank capacity – usable (litres)	85	80	105	105	105	105
Diesel Particulate Filter (DPF)	4	4	■	–	–	–

*Maximum speed for V8 Supercharged is 250kph (155mph) when specified with 22 inch wheels. Not available on LWB.

**When combined with electric motor.

■ Standard – Not Available.

ACCESSORIES





Deployable Side Steps
VPLWP0192

These smart, practical steps make it easier to get in and out of the vehicle. Neatly stowed under the sills, the Side Steps automatically deploy as soon as the door is opened, or when activated by the key fob. They stow automatically when the door is closed. The Side Steps are sensitive to obstructions and will not deploy in off-road or low range settings.



Fixed Side Step
VPLGP0114 (SWB only)

The Fixed Side Step aids entry and exit to the vehicle and improves access to the roof.

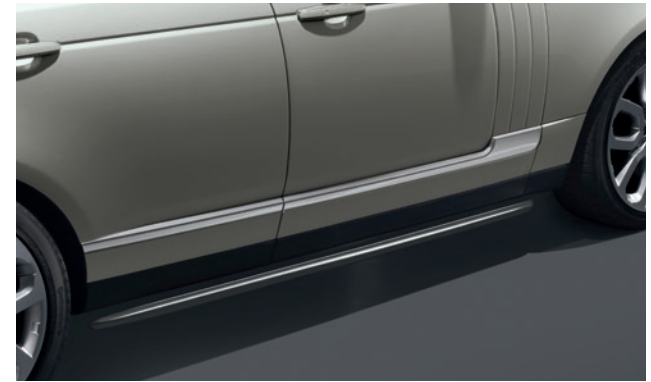

Side Tubes – Bright Finish
VPLGP0100 (SWB only)

Manufactured from stainless steel, with a highly polished finish. Its rugged off-road appearance complements the vehicle's exterior design. Fitting of Side Tubes will affect the off-road capability of the vehicle.



Noble Plated Mirror Caps
VPLGB0073

Noble Plated Mirror Caps complement the Range Rover's exterior styling cues.



Accessory Wheels*

The full range of wheels are also available as an accessory fitment. Wheels shown are manufactured via premium forging process to ensure strength, with striking vibration polished finish.



Styled Valve Caps
LR027666 – Black Jack
LR027664 – Union Jack
LR027560 – Land Rover
LR027663 – Range Rover

Enhance your alloy wheels with the genuine Land Rover valve cap accessories that are offered in a range of styles.

*Rim only. Centre cap not included.

ACCESSORIES

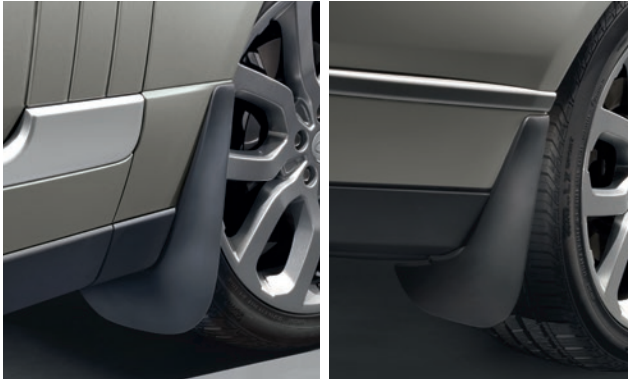

Front Mudflaps
VPLGP0109

Mudflaps reduce spray and help protect the paintwork. Supplied as a pair. Not for use with Deployable Side Steps.

Front Mudflaps (for Deployable Side Steps)
VPLGP0111

Rear Mudflaps
VPLGP0110



Loadspace Rails and D Loops
VPLGS0170

Loadspace mounted rails to help increase the flexibility of loadspace stowage. Loadspace Rails allow fitment of the Luggage Retention Kit stowage system.

Luggage Retention Kit**
VPLGS0171

Pack of attachments that fix into the Loadspace Rails via a quick lock/quick release system to help provide a flexible solution for retaining items. The attachment pack includes a retractable strap with inertia reel, telescopic rod and stowage bag.



Loadspace Mat - Rubber
VPLGS0151

Range Rover branded rubber mat helps protect the rear loadspace carpet from general dirt. Waterproof and non-slip surface.



Loadspace Semi-Rigid Liner
VPLGS0152

Range Rover branded rubber mat helps protect the rear loadspace carpet from general dirt. Semi-rigid waterproof loadspace protector adds a raised lip feature on three sides to protect side wall carpets.



Cargo Barrier - Full height
VPLGS0162

This useful barrier helps prevent cargo from entering the passenger compartment. Incorporates integral ski hatch. Complies with ECE-17 regulation. Not compatible with Rear Executive Class seating.



Rubber Footwell Mats
VPLGS0150 - SWB
VPLGS0254 - LWB

Rubber footwell mats for front and second row occupants help provide protection from general dirt.

**Requires Loadspace Rails with D Loops - Part No: VPLGS0170.



ACCESSORIES



Pedal Kit
VPLGS0160

Pedal caps feature bright design and hidden fixings for a clean finish.



Illuminated Treadplates
LR005081 – SWB
VPLGS0261 – LWB

Illuminated treadplates are available on both the driver and front passenger sides of the vehicle to welcome you into the cabin.

Personalised Illuminated Treadplates
VPLWS0212 – Front
VPLWS0209 – Vehicle Set (SWB only)
VPLGS0262 – Rear (LWB only)

Personalise your vehicle further by adding a script of your choice in a variety of fonts, highlighted by subtle white illumination. Available as a full vehicle set (front pair personalised, rear pair illuminated only) or as a front pair only.



iPad® Holder*
VPLVS0165 – iPad® 2
VPLVS0164 – iPad® 1

Provides secure mounting for your iPad®. Rear seat facing, attaches to the head restraint posts.



Roof Rails**
Consult your Land Rover Dealer for further details

Maximum permissible load capacity 100kgs.[†] Design features pre-set positioning holes/dowels to ensure Cross Bars are fixed in optimum position for weight distribution and dynamics.

Cross Bars**
VPLGR0102

T-track design utilises the full length of the bars, providing space to mount multiple accessories. Aerodynamic profile minimises drag and noise. The incremental height when fitted is 93mm. Roof rails required for fitment.

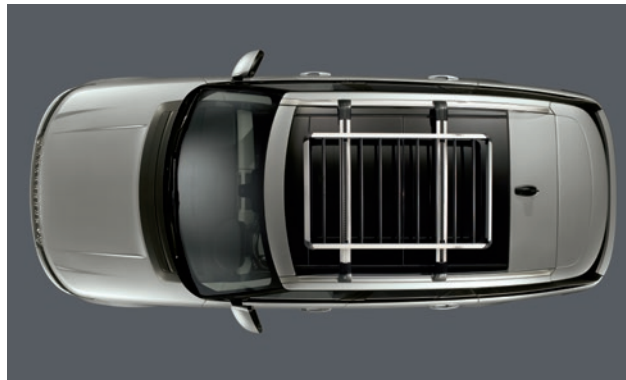

Luggage Carrier**
LR006848

Flexible rack system to facilitate roof carrying. Maximum payload 75kg.[†]

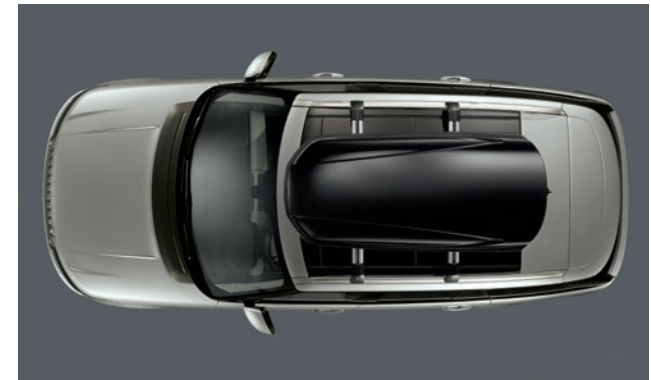

Luggage Box**
VPLVR0062

Available in a range of sizes, all versions can be mounted either side for kerbside opening in any country and include integral locks for security and peace of mind. Carrying capacity ranges from 320 litres with the Sports Box (below) to the 410 litre Luggage Box or the capacious 430 litre Large Roof Box. Maximum payload 75kg.[†]

*Not available with Rear Seat Entertainment with 10.2 inch screens.

**Roof Rails and Cross Bars are required for all Land Rover roof mounted accessories. Objects placed above the roof mounted satellite antenna may reduce the quality of the signal received by the vehicle and could have a detrimental effect on the navigation and satellite radio system, if fitted.

[†]Maximum payload equals the load capacity of the roof mounted accessory.

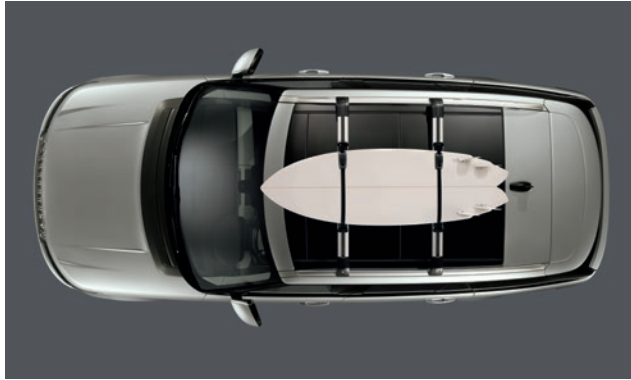

Aqua Sports Carrier*
VPLGR0107

Carries one surfboard, sailboard, canoe or kayak. Includes lockable multi-purpose holder to carry a mast, oars or paddles. Tilts to facilitate easy loading/unloading. Features lockable straps and rubber supports to maintain optimum weight distribution whilst protecting the kayak and vehicle from scratches/scuffs. Maximum payload 45kg/99.2lbs.



Ski/Snowboard Holder*
LR006849

Carries four pairs of skis or two snowboards. Lockable for security. Incorporates slider rails for easy loading. Maximum payload 36kg.**

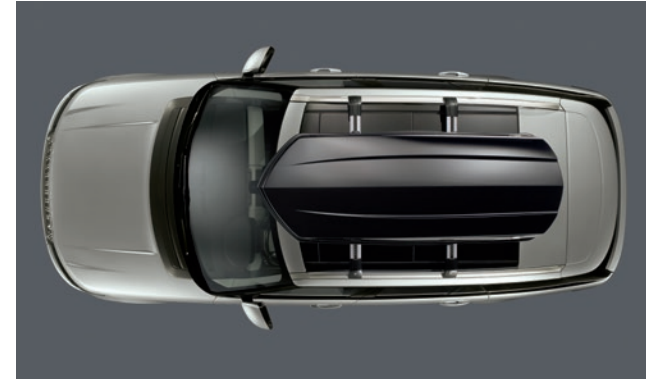

Sports Box*
VPLVR0061

Large Roof Box*
VPLWR0100 (not shown)



Tow Bar Mounted Bike Carrier
VPLVR0067 – 2 Bike
VPLVR0069 – 3 Bike

Upper and lower tailgate can be opened with carrier in place. Features quick attach/release mechanism. Fits to either Multi-Height Tow Bar or Electrically Deployable Tow Bar. Manufactured from aluminium and other lightweight materials. Lockable for security. Maximum load capacity 40kgs.

More information on Land Rover bikes is available online at: www.2x2worldwide.com



Electrically Deployable Tow Bar
VPLGT0117, VPLGB0108, VPLGT0109, VPLGT0108

The Electrically Deployable Tow Bar is stowed discreetly behind the bumper, providing a clean attractive finish. It is designed to deploy/stow in 12 seconds. It's sensitive to obstructions and will stow automatically if necessary. Approved for up to 3,500kg trailer load.

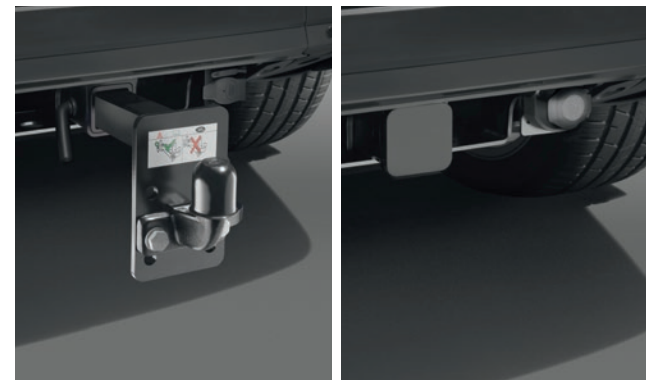

Multi-Height Tow Bar and Armature
VPLGT0082, VPLGT0097,
LR037931, LR037913

Offers three different towing height options and the ability to swap heights in a matter of seconds. Approved for 3,500kg trailer load. Requires Towing Electrics – 13 Pin for fitment.

Towing Electrics – 13 Pin†
VPLGT0073

European-style towing electrics, capable of supplying all trailer rear lighting and interior equipment power. Provided for use with Multi-Height Tow Bar.

*Roof Rails and Cross Bars are required for all Land Rover roof mounted accessories. Objects placed above the roof mounted satellite antenna may reduce the quality of the signal received by the vehicle and could have a detrimental effect on the navigation and satellite radio system, if fitted.

**Maximum payload equals the load capacity of the roof mounted accessory.

†Please note: These accessories are not suitable for caravans, trailers or lighting boards fitted with rear mounted LED Lamp Kits.





BY APPOINTMENT TO
H.M. THE QUEEN
MANUFACTURERS OF
MOTOR VEHICLES
JAGUAR LAND ROVER LIMITED
COVENTRY



BY APPOINTMENT TO
H.R.H. THE DUKE OF EDINBURGH
MANUFACTURERS OF
MOTOR VEHICLES
JAGUAR LAND ROVER LIMITED
COVENTRY



BY APPOINTMENT TO
H.R.H. THE PRINCE OF WALES
MANUFACTURERS OF
MOTOR VEHICLES
JAGUAR LAND ROVER LIMITED
COVENTRY

IMPORTANT NOTICE: Jaguar Land Rover Limited is constantly seeking ways to improve the specification, design and production of its vehicles and alterations take place continually. Whilst every effort is made to produce up to date literature, this brochure should not be regarded as an infallible guide to current specifications, nor does it constitute an offer for the sale of any particular vehicle. Distributors and dealers are not agents of Jaguar Land Rover Limited by any express or implied undertaking or representation.

All Land Rover Approved Accessories fitted by a Land Rover Dealer within one month or 1,600 kilometres/1,000 miles (which ever occurs first) of the handover of a new registered vehicle will benefit from the same warranty terms and period of cover as the vehicle warranty. Accessories purchased outside of these parameters will be subject to a 12 month unlimited mileage warranty. All Land Rover Approved Accessories are rigorously tested to the same exacting standards as those applied to our vehicles. Performance in extreme hot and cold temperatures, corrosion resistance, impact and airbag deployment highlight some of the exhaustive product testing carried out to ensure accessories are both durable and importantly, continue to comply with current legislation.

All our accessories are designed to be an integral part of Land Rover vehicles. While many items such as roof carriers are simple to fit, some products require specialist tools and diagnostic equipment to ensure correct integration with the vehicle structure and electrical systems. These products vary from market to market, please consult your Land Rover Dealer who will be pleased to advise you on current specifications and any query you may have.

The colours reproduced here are subject to the limitations of the printing process and may therefore vary slightly from the actual vehicle. The company reserves the right to alter or withdraw any colour finish without notice. Some of these colours may not be obtainable in your country. Please check availability of colours and current specifications with your Land Rover Dealer. Distributors and dealerships are not agents of Jaguar Land Rover Limited and have absolutely no authority to bind Jaguar Land Rover Limited to any express or implied undertaking or representation.

Castrol EDGE Professional exclusively recommended by Land Rover.

Jaguar Land Rover Limited Registered Office:
Abbey Road, Whitley, Coventry CV3 4LF
United Kingdom.

Registered in England: Number 1672070

landrover.com

© Jaguar Land Rover Limited 2014. Publication Number: LRML 4591/14



RANGE ROVER

2015 AUSTRALIAN SPECIFICATIONS

The information in product brochure LRML 4591/14 is produced for global English markets and may include models, technical data, specifications and accessories not available in Australia. This section of the brochure includes specific Australian models, specifications and options availability.



ABOVE AND BEYOND

RANGE ROVER

RANGE ROVER MODEL	3.0L TDV6 DIESEL	3.0L SDV6 HYBRID	4.4L SDV8 DIESEL	3.0L V6 SUPERCHARGED PETROL	5.0L V8 SUPERCHARGED PETROL
Vehicle – Standard Wheelbase (SWB)					
HSE	■			■	
Vogue	■		■	■	
Vogue SE		■	■		■
Autobiography			■		■
Vehicle – Long Wheelbase (LWB)					
Vogue	■		■		
Vogue SE			■		■
Autobiography			■		■
Autobiography Black			■		■
Vehicle – Standard Wheelbase (SWB)					Recommended Retail Price
3.0L TDV6 DIESEL (190kW)					
HSE					POA
TDV6 Vogue					POA
3.0L SDV6 HYBRID (250kW)					
Vogue SE					POA
4.4L SDV8 DIESEL (250kW)					
Vogue					POA
Vogue SE					POA
Autobiography					POA
3.0L V6 SUPERCHARGED PETROL (250kW)					
HSE					POA
V6 S/C Vogue					POA
5.0L V8 SUPERCHARGED PETROL (375kW)					
V8 S/C Vogue SE					POA
V8 S/C Autobiography					POA
Vehicle – Long Wheelbase (LWB)					
3.0L TDV6 DIESEL (190kW)					
Vogue					POA
4.4L SDV8 DIESEL (250kW)					
Vogue					POA
Vogue SE					POA
Autobiography					POA
Autobiography Black					POA
5.0L V8 SUPERCHARGED PETROL (375kW)					
Vogue SE					POA
Autobiography					POA
Autobiography Black					POA

TECHNICAL SPECIFICATIONS

ENGINE DATA	3.0L TDV6 DIESEL	3.0L SDV6 HYBRID	4.4L SDV8 DIESEL	3.0L V6 SUPERCHARGED PETROL	5.0L V8 SUPERCHARGED PETROL
Capacity (cc)	2,993	2,993	4,367	2,995	5,000
No. of cylinders	V6	V6	V8	V6	V8
Cylinder Layout	Longitudinal	Longitudinal	Longitudinal	Longitudinal	Longitudinal
Valves per cylinder	4	4	4	4	4
Bore (mm)	84	84	84	84.5	92.5
Stroke (mm)	90	90	98.5	89	93
Compression ratio (:1)	16.1	16.1	16.1	10.5	9.5
Maximum power (kW @ rpm)	190@4,000	250kW@4,000	250@3500	250@6,500	375@6,000–6,500
Maximum torque (Nm @ rpm)	600@2,000	700@1,500–3,000	740@1,750–2,300	450@3,500–5,000	625@2,500–5,500
BRAKES					
Front type	Ventilated disc	Ventilated disc	Ventilated disc	Ventilated disc	Ventilated disc
Front diameter (mm)	350	380	380	350	380
Rear type	Ventilated disc	Ventilated disc	Ventilated disc	Ventilated disc	Ventilated disc
Rear diameter (mm)	350	365	365	350	365
WEIGHTS (kg)					
Weight from (SWB/LWB)	2,160/2,301	2,394/–	2,410/2,488	2,222/–	2,330/2,413
Gross Vehicle Weight (SWB/LWB)	3,000/3,050	3,100/–	3,200/3,200	3,050/–	3,150/3,150
Maximum mass on front axle (SWB/LWB)	1,500/1,550	1,550/–	1,550/1,550	1,500/–	1,550/1,550
Maximum mass on rear axle (SWB/LWB)	1,775/1,775	1,775/–	1,775/1,775	1,775/1,775	1,775/1,775
TOWING (kg)					
Unbraked trailer	750	750	750	750	750
Maximum towing	3,500	3,000	3,500	3,500	3,500
Maximum coupling point/nose weight	350	300	350	350	350
Maximum vehicle and trailer combination (SWB/LWB)	6,500/6,550	6,100/–	6,700/6,700	6,550/–	6,650/6,650
ROOF CARRYING (kg)					
Maximum roof load (including roof rails)	100	100	100	100	100
PERFORMANCE					
Maximum speed (km/h)	210	218	218	210	225
Acceleration 0-100 km/h (secs) (SWB/LWB)	7.9/8.3	6.9/–	6.9/7.2	7.4/–	5.4/5.8
Fuel tank capacity – usable (litres)	80	80	105	105	105
FUEL ECONOMY					
Urban (l/100km)	8.5	6.7	11.5	15.6	20.6
Extra Urban (l/100km)	7.0	6.3	7.6	9.1	9.9
Combined (l/100km)	7.5	6.4	8.7	11.5	13.8
CO2 combined emissions (g/km)	196	169	229	268	322

ENGINES, TRANSMISSION AND DRIVING DYNAMICS

STANDARD WHEELBASE MODELS ONLY	CODE	TDV6 HSE	TDV6 VOGUE	SDV6 HYBRID VOGUE SE	SDV8 VOGUE	SDV8 VOGUE SE	SDV8 AUTO- BIOGRAPHY	V6 3.0 S/C HSE	V6 3.0 S/C VOGUE	V8 S/C VOGUE SE	V8 S/C AUTO- BIOGRAPHY
TRANSMISSION & DRIVING DYNAMICS											
Adaptive Dynamics		■	■	■	■	■	■	■	■	■	■
Anti-lock Braking System (ABS)		■	■	■	■	■	■	■	■	■	■
Cornering Brake Control (CBC)		■	■	■	■	■	■	■	■	■	■
Drive Select Rotary Shifter		■	■	■	■	■	■	■	■	■	■
Dynamic Stability Control (DSC)		■	■	■	■	■	■	■	■	■	■
Dynamic Response		-	-	-	■	■	■	-	-	■	■
Eight Speed Automatic Transmission		■	■	■	■	■	■	■	■	■	■
Electric Parking Brake		■	■	■	■	■	■	■	■	■	■
Electronic Air Suspension (with variable ride height)		■	■	■	■	■	■	■	■	■	■
Electronic Brake-force Distribution (EBD)		■	■	■	■	■	■	■	■	■	■
Electronic Cross-linked Air Suspension with Automatic Load Levelling and Multiple Modes (access, normal, intermediate off-road, extended height)		■	■	■	■	■	■	■	■	■	■
Electronic Power Assisted Steering (EPAS)		■	■	■	■	■	■	■	■	■	■
Electronic Stability Program		■	■	■	■	■	■	■	■	■	■
Electronic Traction Control (ETC)		■	■	■	■	■	■	■	■	■	■
Emergency Brake Assist (EBA)		■	■	■	■	■	■	■	■	■	■
Hill Descent Control (HDC)		■	■	■	■	■	■	■	■	■	■
Locking Fuel Flap		■	■	■	■	■	■	■	■	■	■
Permanent Four Wheel Drive (4WD)		■	■	■	■	■	■	■	■	■	■
Reactive Grounding Response		■	■	■	■	■	■	■	■	■	■
Roll Stability Control (RSC)		■	■	■	■	■	■	■	■	■	■
Stop/Start		■	■	■	-	-	-	-	-	-	-
Terrain Response® 2		■	■	■	■	■	■	■	■	■	■
Trailer Stability Assist		■	■	■	■	■	■	■	■	■	■
Twin Speed Low Range Transfer Case		■	■	■	■	■	■	■	■	■	■
20 inch brake calipers		-	-	■	■	■	■	-	-	■	■
Active rear locking differential	027DB	-	-	\$1,120	\$1,120	\$1,120	\$1,120	-	-	\$1,120	\$1,120
FUEL SYSTEM											
Diesel Particular Filter (DPF)		■	■	■	■	■	■	-	-	-	-
No Diesel Particulate Filter (DPF)		-	-	-	-	-	-	■	■	■	■
Diesel Misfueling Protection Device		■	■	■	■	■	■	-	-	-	-

EXTERIOR FEATURES AND FINISHERS

ROOF & EXTERIOR STYLING	CODE	TDV6 HSE	TDV6 VOGUE	SDV6 HYBRID VOGUE SE	SDV8 VOGUE	SDV8 VOGUE SE	SDV8 AUTO-BIOGRAPHY	V6 3.0 S/C HSE	V6 3.0 S/C VOGUE	V8 S/C VOGUE SE	V8 S/C AUTO-BIOGRAPHY
Twin Tailpipes		■	■	■	■	■	■	■	■	■	■
Metal roof	041CY	■	■	●	■	●	●	■	■	●	●
Fixed panoramic roof (including power blinds)	041CX	\$3,400	\$3,400	■	\$3,400	■	■	\$3,400	\$3,400	■	■
Sliding panoramic roof (including power blinds)	041CZ	\$4,200	\$4,200	\$800	\$4,200	\$800	\$800	\$4,200	\$4,200	\$800	\$800
Body coloured roof	080AC	■	■	■	■	■	■	■	■	■	■
Contrast roof – Indus silver	080AD	\$1,010	\$1,010	\$1,010	\$1,010	\$1,010	●	\$1,010	\$1,010	\$1,010	●
Contrast roof – Santorini black	080AN	\$1,010	\$1,010	\$1,010	\$1,010	\$1,010	●	\$1,010	\$1,010	\$1,010	●
Exterior standard bumper pack <i>(Not available with dark atlas exterior accents packs)</i>	074MH	–	–	■	–	■	■	–	–	■	■
Dark Atlas exterior accents pack 1 Front & rear bumper accents, door & fender accents, side vents & front bumper outboard blades <i>(N/A with 080XH Atlas Side Vents. N/A on certain exterior/roof paint colours)</i>	074LX	–	\$1,740	\$1,740	\$1,740	\$1,740	\$1,740	–	\$1,740	\$1,740	\$1,740
Dark Atlas exterior accents pack 2 Front & rear bumper accents, door & fender accents & front bumper outboard blades <i>(N/A with 080XH Atlas Side Vents, N/A on certain exterior/roof paint colours)</i>	074LY	–	\$1,020	\$1,020	\$1,020	\$1,020	\$1,020	–	\$1,020	\$1,020	\$1,020
Atlas side vent graphic <i>(Not available with Dark Atlas Exterior Packs)</i>	080XH	–	\$290	\$290	\$290	\$290	\$290	–	\$290	\$290	\$290
Atlas side vent graphic with bright chrome inserts	080XK	–	–	–	–	–	–	–	–	–	–
GLASS & EXTERIOR MIRRORS											
Rain Sensing Windscreen Wipers		■	■	■	■	■	■	■	■	■	■
Power Windows with remote power locking (global close)		■	■	■	■	■	■	■	■	■	■
Heated Off Screen Wiper Park Position (manual lift away from screen)		■	■	■	■	■	■	■	■	■	■
Rear Wash Wiper		■	■	■	■	■	■	■	■	■	■
Heated Rear Window		■	■	■	■	■	■	■	■	■	■
Acoustic Laminated Windscreen		■	■	■	■	■	■	■	■	■	■
Solar attenuating glass (solar fitted to windscreen only) with laminated hydrophobic front door & laminated rear door & quarter light <i>(Cannot be ordered with 047AH or 047BB Glass)</i>	047AH	■	■	●	■	●	●	■	■	●	●
Solar attenuating glass (solar fitted to windscreen only) with laminated hydrophobic front door glass & privacy glass (rear doors, qtr light and rear windscreen) <i>(Cannot be ordered with 047AH or 047BB Glass)</i>	047AV	\$790	\$790	■	\$790	■	■	\$790	\$790	■	■
Solar attenuating glass (solar fitted to windscreen only) with laminated hydrophobic front door glass & privacy glass (rear doors, qtr light and rear windscreen) <i>(Cannot be ordered with 047AH or 047AV Glass. Includes laminated rear quarter light glass)</i>	047BB	–	–	–	–	–	–	–	–	–	–
Body Coloured Mirror Caps		■	■	■	■	■	■	■	■	■	■
Santorini Black Mirror Caps		–	–	–	–	–	–	–	–	–	–
Adjustable, heated, powerfold memory exterior mirrors with approach lamps and 'Driver Selectable' auto reverse dipping	030NM	■	–	–	–	–	–	■	–	–	–
Adjustable, auto dimming, heated, powerfold memory exterior mirrors with approach lamps and 'Driver Selectable' auto reverse dipping	031EB	\$480	■	■	■	■	■	\$480	■	■	■

EXTERIOR FEATURES AND FINISHERS (CONT)

HEADLAMPS & LIGHTING	CODE	TDV6 HSE	TDV6 VOGUE	SDV6 HYBRID VOGUE SE	SDV8 VOGUE	SDV8 VOGUE SE	SDV8 AUTO-BIOGRAPHY	V6 3.0 S/C HSE	V6 3.0 S/C VOGUE	V8 S/C VOGUE SE	V8 S/C AUTO-BIOGRAPHY
Automatic Headlamps & Headlamp Levelling		■	■	■	■	■	■	■	■	■	■
Centre High Mounted Stop Lamp		■	■	■	■	■	■	■	■	■	■
Follow-me-home Lighting		■	■	■	■	■	■	■	■	■	■
LED Rear Lamps		■	■	■	■	■	■	■	■	■	■
Front & Rear Fog Lamps		■	■	■	■	■	■	■	■	■	■
Side Repeater Indicators in Mirror		■	■	■	■	■	■	■	■	■	■
Xenon headlamps (incl. headlamp powerwash) with DRLs	064CW	■	–	–	–	–	–	■	–	–	–
Xenon headlamps (incl. headlamp powerwash) with signature lighting and LED DRLs	064GI	\$120	■	■	■	■	■	\$120	■	■	■
Adaptive Headlamps	064DI	\$850	\$730	\$730	\$730	\$730	\$730	\$850	\$730	\$730	\$730
Automatic High Beam Assist	030NT	\$310	\$310	■	\$310	■	■	\$310	\$310	■	■
PAINT											
Solid paint	024BC	●	●	●	●	●	●	●	●	●	●
Metallic paint	024AZ	■	■	■	■	■	■	■	■	■	■
Premium metallic paint	024BR	\$1,780	\$1,780	\$1,780	\$1,780	\$1,780	\$1,780	\$1,780	\$1,780	\$1,780	\$1,780
TOWING											
3500kg towing capability		■	■	–	■	■	■	■	■	■	■
3000kg towing capability		–	–	■	–	–	–	–	–	–	–
Electrical Towing Preparation		■	■	■	■	■	■	■	■	■	■
Front & Rear Recovery Hooks		■	■	■	■	■	■	■	■	■	■
Towing Receiver (includes electrics and armature) <i>(Draw Bar is a Dealer Fit Accessory)</i>		■	■	■	■	■	■	■	■	■	■
WHEELS & WHEEL OPTIONS											
19" 5 split spoke Style 501	029SA	■	●	–	–	–	–	■	●	–	–
19" 5 split spoke Style 501 with Satin Dark Grey Finish	029XR	\$1,620	●	–	–	–	–	\$1,620	●	–	–
20" 5 split spoke Style 502	029SB	\$2,430	■	●	■	●	●	\$2,430	■	●	●
20" 5 split spoke Style 502 with Shadow Chrome finish	029SC	\$3,240	\$810	●	\$810	●	●	\$3,240	\$810	●	●
21" 10 spoke Style 101	029SD	\$4,050	\$2,430	\$810	\$2,430	■	●	\$4,050	\$2,430	■	●
21" 10 spoke Style 101 with Diamond Turned finish	029SE	\$4,860	\$3,240	\$810	\$3,240	\$810	●	\$4,860	\$3,240	\$810	●
21" 6 spoke Style 602	029TA	–	–	■	–	–	–	–	–	–	–
21" 6 spoke Style 602 with Diamond Turned finish	029TB	–	–	\$810	–	–	–	–	–	–	–
21" 7 spoke Style 706 with High Gloss Polished finish	029TQ	–	–	–	–	–	–	–	–	–	–
22" 5 split spoke Style 504	029SF	\$5,670	\$4,050	\$2,430	\$4,050	\$2,430	●	\$5,670	\$4,050	\$2,430	●
22" 7 split spoke Style 707 with Diamond Turned finish	029SG	–	–	\$3,240	–	\$3,240	\$1,620	–	–	\$3,240	\$1,620
22" 7 spoke Style 708	029SK	–	–	–	–	–	■	–	–	–	■
22" 6 spoke Style 601 with Diamond Turned finish	029SH	–	–	\$3,240	–	\$3,240	\$1,620	–	–	\$3,240	\$1,620
22" 7 spoke Style 706 with High Gloss Polished finish	029SX	–	–	–	–	–	–	–	–	–	–
21" 9 spoke Style 901 with Gloss Black finish <i>(Requires Black Design pack)</i>	029TN	–	\$3,240	\$1,620	\$3,240	\$1,620	●	–	\$3,240	\$1,620	●
22" 7 split spoke Style 707 with Gloss Black finish <i>(Requires Black Design pack)</i>	029TP	–	\$4,860	\$3,240	\$4,860	\$3,240	\$1,620	–	\$4,860	\$3,240	\$1,620
Locking wheel nuts		■	■	■	■	■	■	■	■	■	■
Full size spare wheel		■	■	■	■	■	■	■	■	■	■
Tyre pressure monitoring system	062AD	\$1,340	■	■	■	■	■	\$1,340	■	■	■

SEATING, INTERIOR FEATURES AND FINISHERS

SEATING MATERIALS	CODE	TDV6 HSE	TDV6 VOGUE	SDV6 HYBRID VOGUE SE	SDV8 VOGUE	SDV8 VOGUE SE	SDV8 AUTO-BIOGRAPHY	V6 3.0 S/C HSE	V6 3.0 S/C VOGUE	V8 S/C VOGUE SE	V8 S/C AUTO-BIOGRAPHY
Grained leather (with PVC map pockets)		■	-	-	-	-	-	■	-	-	-
Oxford leather (with PVC map pockets)		-	■	-	■	-	-	-	■	-	-
Semi aniline leather (With Oxford leather map pockets)		-	-	■	-	■	■	-	-	■	■
Perforated semi-aniline leather		-	-	-	-	-	-	-	-	-	-
Extended interior trim palette	033YY	-	-	-	-	-	\$1,140	-	-	-	\$1,140
Front row leather covered seat-back pockets	033ML	■	■	■	■	■	■	■	■	■	■
Front row carpet covered seat-back pockets with leather edge	033MM	-	-	-	-	-	-	-	-	-	-
SEATING FUNCTIONALITY											
Grained leather seat style 1											
10 way drivers/10 way passenger front seats, (8 way electric front seats/2 way manual headrests), Heated front seats, 2 way driver & passenger lumbar, Drivers memory, Rear bench seat with load through facility and rear manual recline (N/A with 129AQ 10.2" RSE)	033SA	■	-	-	-	-	-	■	-	-	-
Grained leather seat style 2											
10 way drivers/10 way passenger front seats, (8 way electric front seats/2 way manual headrests), Heated front and rear seats, 2 way driver & passenger lumbar, Drivers memory, Rear bench seat with load through facility and rear manual recline (N/A with 129AQ 10.2" RSE)	033SB	\$650	-	-	-	-	-	\$650	-	-	-
Oxford leather seat style 3											
16 way drivers/16 way passenger front seats, (12 way electric front seats/4 way manual headrests), Heated front and rear seats, 4 way lumbar, Drivers memory, Rear bench seat with load through facility and rear manual recline (N/A with 129AQ 10.2" RSE)	033SH	-	■	-	■	-	-	-	■	-	-
Oxford leather seat style 6											
18 way drivers/18 way passenger front seats, (14 way electric front seats/4 way manual headrests), Front climate seats with heated rear seats, Adjustable seat bolsters, Driver and passenger memory, Rear bench seat with load through facility and rear manual recline (N/A with 129AQ 10.2" RSE)	033SL	-	\$2,780	-	\$2,780	-	-	-	\$2,780	-	-
Oxford leather seat style 15											
18 way drivers/18 way passenger front seats, (14 way electric front seats/4 way manual headrests), Climate front and rear seats, Massage front seats with adjustable seat bolsters, Driver and passenger memory, Rear bench seat with load through facility with rear power recline and rear power seat fold, 4 way rear seat power lumbar, Passenger seat away (N/A with 129AQ 10.2" RSE)	033SF	-	\$5,530	-	\$5,530	-	-	-	\$5,530	-	-
Semi Aniline leather seat style 18											
20 way drivers / 20 way passenger front seats, (18 way electric front seats/2 way manual headrests), Climate front and rear seats, Adjustable seat bolsters, Driver and passenger memory, Rear bench seat with load through facility with rear power recline, seat fold, & intelligent seat cargo model, 4 way rear seat power lumbar, Passenger seat away (N/A with 129AQ 10.2" RSE)	033SW	-	-	■	-	■	-	-	-	■	-
Semi Aniline leather seat style 19											
22 way drivers/22 way passenger front seats, (18 way electric front seats/4 way manual headrests), Climate front and rear seats, Massage front seats with adjustable seat bolsters, river and passenger memory, Rear bench seat with load through facility with rear power recline, seat fold, & intelligent seat cargo model, 4 way rear seat power lumbar, Passenger seat away (Available on Vogue/Vogue SE in Tan & Pimento colourways only N/A with 129AQ 10.2" RSE)	033SG	-	-	\$880	-	\$880	■	-	-	\$880	■
Semi Aniline leather rear executive class seat style 21											
22 way drivers/22 way passenger front seats, (18 way electric front seats/4 way manual headrests), Climate front and rear seats, Massage front seats with adjustable seat bolsters, Driver and passenger memory, Rear executive class seating with rear power recline, Rear seat massage lumbar, Passenger seat away (N/A with 129AQ 10.2" RSE)	033SP	-	-	-	-	-	\$6,150	-	-	-	\$6,150
Semi Aniline leather seat style 23											
22 way drivers/22 way passenger front seats, (20 way electric front seats/2 way manual headrests), Climate front and rear seats, Adjustable seat bolsters, Driver and passenger memory, Rear bench seat with load through facility with rear power recline, seat fold, & intelligent seat cargo model, 4 way rear seat power lumbar, Passenger seat away, Driver and Front Passenger Upper Seat Articulation (N/A with 129AH 8.0" RSE)	033TK	-	-	\$1,140	-	\$1,140	-	-	-	\$1,140	-

SEATING, INTERIOR FEATURES AND FINISHERS (CONT)

SEATING MATERIALS	CODE	TDV6 HSE	TDV6 VOGUE	SDV6 HYBRID VOGUE SE	SDV8 VOGUE	SDV8 VOGUE SE	SDV8 AUTO-BIOGRAPHY	V6 3.0 S/C HSE	V6 3.0 S/C VOGUE	V8 S/C VOGUE SE	V8 S/C AUTO-BIOGRAPHY
Semi Aniline leather seat style 24 22 way drivers/22 way passenger front seats, (20 way electric front seats/2 way manual headrests), Climate front and rear seats, Massage front seats with adjustable seat bolsters, Driver and passenger memory, Rear bench seat with load through facility with rear power recline, seat fold, & intelligent seat cargo model, 4 way rear seat power lumbar, Passenger seat away, Driver and Front Passenger Upper Seat Articulation <i>(Available on Vogue/Vogue SE in Tan & Pimento colourways only. N/A with 129AH 8.0" RSE)</i>	033T	-	-	\$2,020	-	\$2,020	\$1,140	-	-	\$2,020	\$1,140
Semi Aniline leather rear executive class seat style 25 22 way drivers/22 way passenger front seats, (20 way electric front seats/2 way manual headrests), Climate front and rear seats, Massage front seats with adjustable seat bolsters, Driver and passenger memory, Rear executive class seating with rear power recline, (LWB is Extended power recline), Rear seat massage lumbar, Passenger seat away, Driver and Front Passenger Upper Seat Articulation <i>(N/A with 129AH 8.0" RSE)</i>	033TM	-	-	\$10,160	-	\$10,160	-	-	-	\$10,160	-
Semi Aniline leather rear executive class seat style 26 24 way drivers/24 way passenger front seats, (20 way electric front seats/4 way manual headrests), Climate front and rear seats, Massage front seats with adjustable seat bolsters, Driver and passenger memory, Rear executive class seating with rear power recline, (LWB is Extended power recline), Rear seat massage lumbar, Passenger seat away, Driver and Front Passenger Upper Seat Articulation <i>(N/A with 129AH 8.0" RSE)</i>	033TN	-	-	-	-	-	\$7,290	-	-	-	\$7,290
SEATING FUNCTIONALITY (CONTINUED)											
Driver & Passenger Front Seat Armrests		■	■	■	■	■	■	■	■	■	■
Map Pockets (rear of front seats)		■	■	■	■	■	■	■	■	■	■
Rear Bench Seat with Load Through Facility		■	■	■	■	■	■	■	■	■	■
Rear Centre Armrest <i>(Includes rear storage compartment when equipped with Rear Seat Entertainment System)</i>		■	■	■	■	■	■	■	■	■	■
Standard headrest front & rear (2 way tilt)		■	-	-	-	-	-	■	-	-	-
Standard headrest front & rear (4 way tilt)		-	■	-	■	-	-	-	■	-	-
Winged headrests front <i>(Requires 129AH RSE)</i>	033DK	●	-	-	-	-	-	●	-	-	-
Winged headrests front & rear	033DP	-	\$940	■	\$940	■	■	-	\$940	■	■
Embossed 'Autobiography' script on centre rear squab		-	-	-	-	-	■	-	-	-	■
INTERIOR FINISHERS & HEADLINING											
Figured Macassar	088GF	■	■	■	■	■	■	■	■	■	■
Grand Black Lacquer	088EH	\$650	●	●	●	●	●	\$650	●	●	●
Shadow Walnut	088HF	-	\$650	●	\$650	●	●	-	\$650	●	●
Extended veneer pack	032EJ	■	■	■	■	■	■	■	■	■	■
Morzine headlining (Cirrus & Ivory)	088HH	■	■	■	■	■	-	■	■	■	-
Morzine headlining (Ebony)	005BJ	\$650	\$650	\$650	\$650	\$650	-	\$650	\$650	\$650	-
Alston headlining <i>(Cirrus, Ivory or Ebony, with leather handle. Only available with twin blade sunvisor)</i>	088HE	\$2,760	\$2,760	\$2,760	\$2,760	\$2,760	■	\$2,760	\$2,760	\$2,760	■
Leather headlining <i>(Cirrus, Ivory or Ebony, with leather handle. Only available with sliding panoramic roof)</i>	088FE	-	-	-	-	-	●	-	-	-	●
Leather perforated headlining	088HV	-	-	-	-	-	-	-	-	-	-

SEATING, INTERIOR FEATURES AND FINISHERS (CONT)

STEERING WHEEL	CODE	TDV6 HSE	TDV6 VOGUE	SDV6 HYBRID VOGUE SE	SDV8 VOGUE	SDV8 VOGUE SE	SDV8 AUTO- BIOGRAPHY	V6 3.0 S/C HSE	V6 3.0 S/C VOGUE	V8 S/C VOGUE SE	V8 S/C AUTO- BIOGRAPHY
Power Adjustable Steering Column (entry/exit, tilt, reach & rake)		■	■	■	■	■	■	■	■	■	■
Multi-function Controls on Steering Wheel		■	■	■	■	■	■	■	■	■	■
Leather steering wheel <i>(Includes Noble gear shift paddles on Autobiography)</i>	032DU	■	-	-	-	-	-	■	-	-	-
Heated leather steering wheel <i>(Includes Noble gear shift paddles on Autobiography)</i>	032DV	\$320	■	■	■	■	■	\$320	■	■	■
Heated wood & leather steering wheel (steering wheel matches veneer) <i>(Includes Noble gear shift paddles on Autobiography)</i>	032DR	\$1,300	\$980	\$980	\$980	\$980	●	\$1,300	\$980	\$980	●
INTERIOR FEATURES											
Auto-dimming Interior Mirror		■	■	■	■	■	■	■	■	■	■
Illuminated Vanity Mirror		■	■	■	■	■	■	■	■	■	■
Front & Rear Cupholders		■	■	■	■	■	■	■	■	■	■
Secure Glove Box Stowage		■	■	■	■	■	■	■	■	■	■
Twin blade sunvisor <i>(Requires 088HE Alston Headlining)</i>	115AP	●	■	■	■	■	■	●	■	■	■
Front centre console compartment		■	■	■	■	■	-	■	■	■	-
Front centre console cooler compartment	038EA	\$580	\$580	\$580	\$580	\$580	■	\$580	\$580	\$580	■
Rear centre console cooler compartment <i>(Requires Rear Executive Class Seating)</i>	038FB	-	-	-	-	-	\$580	-	-	-	\$580
Rear centre console with bottle chiller		-	-	-	-	-	-	-	-	-	-
3 zone climate control		■	■	■	■	■	-	■	■	■	-
4 zone climate control	022BG	\$2,110	\$2,110	-	\$2,110	\$2,110	■	\$2,110	\$2,110	\$2,110	■
4 zone climate control – Hybrid only	022BL	-	-	\$2,110	-	-	-	-	-	-	-
Interior Mood Lighting		■	■	-	■	-	-	■	■	-	-
Customer configurable interior mood lighting	064FC	\$570	\$570	■	\$570	■	■	\$570	\$570	■	■
Premium Customer configurable interior mood lighting		-	-	-	-	-	-	-	-	-	-
Non smokers pack (stowage bin)	094AB	■	■	■	■	■	■	■	■	■	■
Front & rear carpet mats	079AJ	■	■	■	■	■	-	■	■	■	-
Front & rear carpet mats with contrast edge and metal corners	079BO	-	-	-	-	-	■	-	-	-	■
Rear manual footrest		-	-	-	-	-	-	-	-	-	-
Bright pedals	051AJ	-	■	■	■	■	■	-	■	■	■
Aluminium Treadplates with Range Rover Lettering		■	■	-	■	-	■	■	■	-	■
Illuminated aluminium tread plates with Range Rover lettering <i>(Lettering on front sill)</i>	048BD	\$1,620	\$1,620	■	\$1,620	■	-	\$1,620	\$1,620	■	-
Illuminated aluminium tread plates with Autobiography lettering <i>(Lettering on front & rear sill)</i>	048BJ	-	-	-	-	-	■	-	-	-	■
Illuminated aluminium tread plates with unique Autobiography lettering	048AT	-	-	-	-	-	-	-	-	-	-
Rear window powered sun blinds	112RB	-	-	-	-	-	-	-	-	-	-
Deployable tables with leather finish	038GC	-	-	-	-	-	-	-	-	-	-
Deployable tables with wood finish	038GD	-	-	-	-	-	-	-	-	-	-

SEATING, INTERIOR FEATURES AND FINISHERS (CONT)

SAFETY & SECURITY	CODE	TDV6 HSE	TDV6 VOGUE	SDV6 HYBRID VOGUE SE	SDV8 VOGUE	SDV8 VOGUE SE	SDV8 AUTO-BIOGRAPHY	V6 3.0 S/C HSE	V6 3.0 S/C VOGUE	V8 S/C VOGUE SE	V8 S/C AUTO-BIOGRAPHY
Active Speed Limiter (ASL)		■	■	■	■	■	■	■	■	■	■
Customer Configurable Autolock (doors lock on driveway)		■	■	■	■	■	■	■	■	■	■
Driver and Passenger Airbags (side, seat-front, thorax, pelvis)		■	■	■	■	■	■	■	■	■	■
Front Height Adjustable Seat Belts		■	■	■	■	■	■	■	■	■	■
Hazard Lights Under Heavy Braking		■	■	■	■	■	■	■	■	■	■
Power Operated Child Locks		■	■	■	■	■	■	■	■	■	■
Single Point Entry (configurable)		■	■	■	■	■	■	■	■	■	■
Volumetric alarm (includes battery back up sounder)		■	■	■	■	■	■	■	■	■	■
First aid kit		■	■	■	■	■	■	■	■	■	■

CONVENIENCE AND LOADSPACE FEATURES

CONVENIENCE FEATURES	CODE	TDV6 HSE	TDV6 VOGUE	SDV6 HYBRID VOGUE SE	SDV8 VOGUE	SDV8 VOGUE SE	SDV8 AUTO-BIOGRAPHY	V6 3.0 S/C HSE	V6 3.0 S/C VOGUE	V8 S/C VOGUE SE	V8 S/C AUTO-BIOGRAPHY
Push Button Start		■	■	■	■	■	■	■	■	■	■
Front & Rear Park Distance Sensors with Visual Display		■	■	■	■	■	■	■	■	■	■
Park Assist – Parallel Parking/Parking Exit/Perpendicular parking/360° Park Distance Control	086HA	P12	P12	P12	P12	P12	P12	P12	P12	P12	P12
Lane Departure Warning	086BC	P12	P12	P12	P12	P12	P12	P12	P12	P12	P12
Rear view camera	086FA	■	■	–	■	–	–	■	■	–	–
Surround camera system <i>(Includes junction view, with trailer reverse park guidance and trailer hitch guidance. Requires 031EB Auto-dim Mirrors)</i>	086GC	\$1,300	\$1,300	■	\$1,300	■	■	\$1,300	\$1,300	■	■
Blind Spot Monitor and Closing Vehicle Sensing <i>(Requires 031EB Auto-dim Mirrors)</i>	086GH	\$840	\$840	\$840	\$840	\$840	–	\$840	\$840	\$840	–
Blind Spot Monitor with Closing Vehicle Sensing and Reverse Traffic Detection <i>(Requires 031EB Auto-dim Mirrors)</i>	086GF	\$1,000	\$1,000	\$1,000	\$1,000	\$1,000	■	\$1,000	\$1,000	\$1,000	■
Wade Sensing™ <i>(Requires 086GH Blind Spot Monitor & 031EB Mirrors)</i>	075EA	\$570	\$570	\$570	\$570	\$570	■	\$570	\$570	\$570	■
HomeLink®	025FG	\$410	\$410	\$410	\$410	\$410	\$410	\$410	\$410	\$410	\$410
Cruise Control		■	■	■	■	■	–	■	■	■	–
Adaptive Cruise Control (ACC) incorporating queue assist with intelligent emergency braking and active seat belts	065AG	\$3,240	\$3,240	\$3,240	\$3,240	\$3,240	■	\$3,240	\$3,240	\$3,240	■
Soft door close	076FC	■	■	■	■	■	■	■	■	■	■
Keyless entry	066AC	■	■	■	■	■	■	■	■	■	■
Extra large additional washer bottle <i>(Standard Washer Bottle = 6.0 litres, Additional Washer Bottle = 2.1 litres)</i>		■	■	■	■	■	■	■	■	■	■
LOADSPACE FEATURES											
Load Compartment Light		■	■	■	■	■	■	■	■	■	■
Loadspace Cover (hinged with hardcover)		■	■	■	■	■	■	■	■	■	■
Loadspace Anchor Points		■	■	■	■	■	■	■	■	■	■
Loadspace rails and lockable cross beam	135AH	\$540	\$540	\$540	\$540	\$540	\$540	\$540	\$540	\$540	\$540
Power upper & lower trunk/tailgate		■	■	■	■	■	■	■	■	■	■

CONVENIENCE AND LOADSPACE FEATURES (CONT)

INFORMATION, COMMUNICATIONS & ENTERTAINMENT	CODE	TDV6 HSE	TDV6 VOGUE	SDV6 HYBRID VOGUE SE	SDV8 VOGUE	SDV8 VOGUE SE	SDV8 AUTO-BIOGRAPHY	V6 3.0 S/C HSE	V6 3.0 S/C VOGUE	V8 S/C VOGUE SE	V8 S/C AUTO-BIOGRAPHY
8" Touch Screen		■	■	■	■	■	■	■	■	■	■
Auxiliary Power Sockets (front, 2nd row and loadspace 12V)		■	■	■	■	■	■	■	■	■	■
Bluetooth® Phone Connection & Audio Streaming		■	■	■	■	■	■	■	■	■	■
Full TFT/LCD Instrument Cluster		■	■	■	■	■	■	■	■	■	■
HDD Navigation System		■	■	■	■	■	■	■	■	■	■
Off Road Navigation with TMC (Dynamic Route Guidance)		■	■	■	■	■	■	■	■	■	■
User Selectable Screen Savers		■	■	■	■	■	■	■	■	■	■
Row 1 USB socket		■	■	■	■	■	■	■	■	■	■
Voice Control – “Say What You See” Intuitive Voice Control		■	■	■	■	■	■	■	■	■	■
Meridian audio system (380W)	025LM	■	■	–	■	–	–	■	■	–	–
Meridian surround sound audio system (825W)	025LN	\$2,270	\$2,270	■	\$2,270	■	■	\$2,270	\$2,270	■	■
Meridian signature reference audio system (1700w)	025LV	–	–	\$7,790	–	\$7,790	\$7,790	–	–	\$7,790	\$7,790
Digital audio broadcast radio (DAB+)	025JB	\$730	\$730	\$730	\$730	\$730	\$730	\$730	\$730	\$730	\$730
TV – Digital	129AK	\$1,620	■	■	■	■	■	\$1,620	■	■	■
Touch screen with dual view technology (inc 1 set of wireless headphones)	087AM	\$1,300	\$1,300	■	\$1,300	■	■	\$1,300	\$1,300	■	■
Rear seat entertainment system with remote control (inc 2 sets of wireless headphones and one USB in second row) with 8" screens (On LWB models, Navigation feature of ‘Journey Status’ is included)	129AH	\$3,710	\$3,240	■	\$3,240	■	■	\$3,710	\$3,240	■	■
Rear seat entertainment system with remote control (inc 2 sets of wireless headphones and one USB in second row) with 10.2" screens (On LWB models, Navigation feature of ‘Journey Status’ is included)	129AQ	–	–	\$1,950	–	\$1,950	\$1,950	–	–	\$1,950	\$1,950

OPTION PACKS

	CODE	TDV6 HSE	TDV6 VOGUE	SDV6 HYBRID VOGUE SE	SDV8 VOGUE	SDV8 VOGUE SE	SDV8 AUTO-BIOGRAPHY	V6 3.0 S/C HSE	V6 3.0 S/C VOGUE	V8 S/C VOGUE SE	V8 S/C AUTO-BIOGRAPHY
Pack 12 (P12) – Parking pack Park Assist – Parallel Parking/Parking Exit/Perpendicular parking/360° Park Distance Control & Lane Departure Warning (Requires 031EB Auto-dim Mirrors & 030NT Auto-High Beam Assist. N/A with 025FG Homelink)	086JA	\$4,360	\$4,360	\$4,360	\$4,360	\$4,360	\$4,360	\$4,360	\$4,360	\$4,360	\$4,360
Black Design Pack Santorini Gloss Black Mirror Caps, Exterior Accents, Range Rover script on tailgate and bonnet, Bumper vanes, Front Grille, Toweye Cover, Tailgate lid finisher, Bonnet Finisher, Side Vent Graphic, Wheel Nuts (N/A with Dark Atlas Accent or 080XH Atlas Side Vent. Requires 029TN or 029TP Wheels)	074LN	–	\$2,600	\$2,600	\$2,600	\$2,600	\$2,600	–	\$2,600	\$2,600	\$2,600

RANGE ROVER LONG WHEELBASE

The first Range Rover long wheelbase in 20 years, this new body style will cater for a growing group of consumers looking for the ultimate SUV, and an alternative to the traditional long wheelbase saloon cars in this segment. Clever packaging has increased rear legroom by 140mm for rear seat passengers.

ENGINES, TRANSMISSION AND DRIVING DYNAMICS

LONG WHEELBASE MODELS ONLY	CODE	TDV6 VOGUE	SDV8 VOGUE	SDV8 VOGUE SE	SDV8 AUTO-BIOGRAPHY	SDV8 AUTO-BIOGRAPHY BLACK	V8 S/C VOGUE SE	V8 S/C AUTO-BIOGRAPHY	V8 S/C AUTO-BIOGRAPHY BLACK
Feature in addition to Standard Wheelbase (SWB) equipment									
ENGINES									
TDV6 Diesel		■	-	-	-	-	-	-	-
SDV6 Diesel Hybrid		-	-	-	-	-	-	-	-
SDV8 Diesel		-	■	■	■	■	-	-	-
V6 Supercharged Petrol		-	-	-	-	-	-	-	-
V8 Supercharged Petrol		-	-	-	-	-	■	■	■
FUEL SYSTEM									
Diesel Particular Filter (DPF)		■	■	■	■	■	-	-	-
No Diesel Particulate Filter (DPF)		-	-	-	-	-	■	■	■
Diesel Misfueling Protection Device		■	■	■	■	■	-	-	-

EXTERIOR FEATURES AND FINISHERS

ROOF & EXTERIOR STYLING	CODE	TDV6 VOGUE	SDV8 VOGUE	SDV8 VOGUE SE	SDV8 AUTO-BIOGRAPHY	SDV8 AUTO-BIOGRAPHY BLACK	V8 S/C VOGUE SE	V8 S/C AUTO-BIOGRAPHY	V8 S/C AUTO-BIOGRAPHY BLACK
Metal roof	041CY	-	-	-	-	-	-	-	-
Fixed panoramic roof (including power blinds)	041CX	■	■	■	■	■	■	■	■
Sliding panoramic roof (including power blinds)	041CZ	\$800	\$800	\$800	\$800	\$800	\$800	\$800	\$800
Exterior standard bumper pack	074MH	-	-	■	■	-	■	■	-
Dark Atlas exterior accents pack 1 Front & rear bumper accents, door & fender accents, side vents & front bumper outboard blades	074LX	\$1,740	\$1,740	\$1,740	\$1,740	-	\$1,740	\$1,740	-
Dark Atlas exterior accents pack 2 Front & rear bumper accents, door & fender accents & front bumper outboard blades	074LY	\$1,020	\$1,020	\$1,020	\$1,020	-	\$1,020	\$1,020	-
Atlas side vent graphic	080XH	\$290	\$290	\$290	\$290	-	\$290	\$290	-
Atlas side vent graphic with bright chrome inserts	080XK	-	-	-	-	\$290	-	-	\$290
GLASS & EXTERIOR MIRRORS									
Solar attenuating glass (solar fitted to windscreen only) with laminated hydrophobic front door glass & privacy glass (rear doors, qtr light and rear windscreen)	047AV	-	-	-	-	-	-	-	-
Solar attenuating glass (solar fitted to windscreen only) with laminated hydrophobic front door glass & privacy glass (rear doors, qtr light and rear windscreen)	047BB	\$790	\$790	■	■	■	■	■	■
Body Coloured Mirror Caps		-	-	-	-	-	-	-	-
Santorini Black Mirror Caps		■	■	■	■	■	■	■	■

EXTERIOR FEATURES AND FINISHERS (CONT)

HEADLAMPS & LIGHTING	CODE	TDV6 VOGUE	SDV8 VOGUE	SDV8 VOGUE SE	SDV8 AUTO-BIOGRAPHY	SDV8 AUTO-BIOGRAPHY BLACK	V8 S/C VOGUE SE	V8 S/C AUTO-BIOGRAPHY	V8 S/C AUTO-BIOGRAPHY BLACK
Adaptive Headlamps	064DI	\$730	\$730	\$730	\$730	■	\$730	\$730	■
PAINT									
Solid paint	024BC	●	●	●	●	●	●	●	●
Metallic paint	024AZ	■	■	■	■	■	■	■	■
Premium metallic paint	024BR	\$1,780	\$1,780	\$1,780	\$1,780	●	\$1,780	\$1,780	●
WHEELS & WHEEL OPTIONS									
21" 7 spoke Style 706 with High Gloss Polished finish	029TQ	-	-	-	-	●	-	-	●
22" 7 split spoke Style 707 with Diamond Turned finish	029SG	-	-	\$3,240	\$2,430	●	\$3,240	\$2,430	●
22" 7 spoke Style 708	029SK	-	-	-	■	●	-	■	●
22" 6 spoke Style 601 with Diamond Turned finish	029SH	-	-	\$3,240	\$2,430	●	\$3,240	\$2,430	●
22" 7 spoke Style 706 with High Gloss Polished finish	029SX	-	-	-	-	■	-	-	■
21" 9 spoke Style 901 with Gloss Black finish	029TN	\$3,240	\$3,240	\$1,620	\$810	-	\$2,430	\$810	-
22" 7 split spoke Style 707 with Gloss Black finish	029TP	\$4,860	\$4,860	\$3,240	\$2,430	-	\$3,240	\$2,430	-

SEATING, INTERIOR FEATURES AND FINISHERS

SEATING MATERIALS	CODE	TDV6 VOGUE	SDV8 VOGUE	SDV8 VOGUE SE	SDV8 AUTO-BIOGRAPHY	SDV8 AUTO-BIOGRAPHY BLACK	V8 S/C VOGUE SE	V8 S/C AUTO-BIOGRAPHY	V8 S/C AUTO-BIOGRAPHY BLACK
Semi aniline leather (With Oxford leather map pockets)		-	-	■	■	-	■	■	-
Perforated semi-aniline leather		-	-	-	-	■	-	-	■
Extended interior trim palette	033YY	-	-	-	\$1,140	-	-	\$1,140	-
Front row leather covered seat-back pockets	033ML	■	■	■	■	■	■	■	■
Front row carpet covered seat-back pockets with leather edge	033MM	-	-	-	-	●	-	-	●
SEATING FUNCTIONALITY									
Semi Aniline leather seat style 19 22 way drivers/22 way passenger front seats, (18 way electric front seats/4 way manual headrests), Climate front and rear seats, Massage front seats with adjustable seat bolsters, Driver and passenger memory, Rear bench seat with load through facility with rear power recline, 4 way rear seat power lumbar, Passenger seat away	033SG	-	-	\$880	-	-	\$880	-	-
Semi Aniline leather rear executive class seat style 21 22 way drivers/22 way passenger front seats, (18 way electric front seats/4 way manual headrests), Climate front and rear seats, Massage front seats with adjustable seat bolsters, Driver and passenger memory, Rear executive class seating with rear power recline, Rear seat massage lumbar, Passenger seat away	033SP	-	-	-	-	-	-	-	-
Semi Aniline leather seat style 24 22 way drivers/22 way passenger front seats, (20 way electric front seats/2 way manual headrests), Climate front and rear seats, Massage front seats with adjustable seat bolsters, Driver and passenger memory, Rear bench seat with load through facility with rear power recline, 4 way rear seat power lumbar, Passenger seat away, Driver and Front Passenger Upper Seat Articulation	033TL	-	-	\$2,020	■	-	\$2,020	■	-

SEATING, INTERIOR FEATURES AND FINISHERS (CONT)

SEATING FUNCTIONALITY	CODE	TDV6 VOGUE	SDV8 VOGUE	SDV8 VOGUE SE	SDV8 AUTO-BIOGRAPHY	SDV8 AUTO-BIOGRAPHY BLACK	V8 S/C VOGUE SE	V8 S/C AUTO-BIOGRAPHY	V8 S/C AUTO-BIOGRAPHY BLACK
Semi Aniline leather rear executive class seat style 26 24 way drivers/24 way passenger front seats, (20 way electric front seats/4 way manual headrests), Climate front and rear seats, Massage front seats with adjustable seat bolsters, Driver and passenger memory, Rear executive class seating with rear power recline, (LWB is Extended power recline), Rear seat massage lumbar, Passenger seat away, Driver and Front Passenger Upper Seat Articulation	033TN	-	-	-	\$6,150	-	-	\$6,150	-
Semi Aniline leather rear executive class seat style 28 24 way drivers/24 way passenger front seats, (20 way electric front seats/4 way manual headrests), Climate front and rear seats, Massage front seats with adjustable seat bolsters, Driver and passenger memory, Rear executive class seating with ski hatch and extended rear power recline, Rear seat massage lumbar, Passenger seat away, Driver and Front Passenger Upper Seat Articulation, Calf Rest	033TP	-	-	-	-	■	-	-	■
Poltroa Frau leather rear executive class seat style 30 24 way drivers/24 way passenger front seats, (20 way electric front seats/4 way manual headrests), Climate front and rear seats, Massage front seats with adjustable seat bolsters, Driver and passenger memory, Rear executive class seating with ski hatch and extended rear power recline, Rear seat massage lumbar, Passenger seat away, Driver and Front Passenger Upper Seat Articulation, Calf Rest	033TU	-	-	-	-	\$6,150	-	-	\$6,150
SEATING FUNCTIONALITY (CONTINUED)									
Embossed 'Autobiography' script on centre rear squab		-	-	-	■	-	-	■	-
INTERIOR FINISHERS & HEADLINING									
Alston headlining	088HE	\$2,760	\$2,760	\$2,760	■	-	\$2,760	■	-
Leather headlining	088FE	-	-	-	●	-	-	●	-
Leather perforated headlining	088HV	-	-	-	-	■	-	-	■
STEERING WHEEL									
Heated leather steering wheel	032DV	■	■	■	■	●	■	■	●
Heated wood & leather steering wheel (steering wheel matches veneer)	032DR	\$980	\$980	\$980	●	■	\$980	●	■
INTERIOR FEATURES									
Rear centre console cooler compartment	038FB	-	-	-	\$580	-	-	\$580	-
Rear centre console with bottle chiller		-	-	-	-	■	-	-	■
Interior Mood Lighting		-	-	-	-	■	-	-	■
Customer configurable interior mood lighting	064FC	■	■	■	■	-	■	■	-
Premium Customer configurable interior mood lighting		-	-	-	-	■	-	-	■
Rear manual footrest		-	-	-	-	■	-	-	■
Aluminium Treadplates with Range Rover Lettering		-	-	-	■	■	-	■	■
Illuminated aluminium tread plates with Range Rover lettering	048BD	■	■	■	-	-	■	-	-
Illuminated aluminium tread plates with Autobiography lettering	048BJ	-	-	-	■	-	-	■	-
Illuminated aluminium tread plates with unique Autobiography lettering	048AT	-	-	-	-	■	-	-	■
Rear window powered sun blinds	112RB	■	■	■	■	■	■	■	■
Deployable tables with leather finish	038GC	-	-	-	-	■	-	-	■
Deployable tables with wood finish	038GD	-	-	-	-	●	-	-	●

CONVENIENCE AND LOADSPACE FEATURES

CONVENIENCE FEATURES	CODE	TDV6 VOGUE	SDV8 VOGUE	SDV8 VOGUE SE	SDV8 AUTO-BIOGRAPHY	SDV8 AUTO-BIOGRAPHY BLACK	V8 S/C VOGUE SE	V8 S/C AUTO-BIOGRAPHY	V8 S/C AUTO-BIOGRAPHY BLACK
HomeLink®	025FG	\$410	\$410	–	–	\$410	–	–	\$410
LOADSPACE FEATURES									
Loadspace rails and lockable cross beam	135AH	\$540	\$540	\$540	\$540	●	\$540	\$540	●
INFORMATION, COMMUNICATIONS & ENTERTAINMENT									
Meridian surround sound audio system (825W)	025LN	\$2,270	\$2,270	■	■	–	■	■	–
Meridian signature reference audio system (1700w)	025LV	–	–	\$7,790	\$7,790	■	\$7,790	\$7,790	■
Rear seat entertainment system with remote control (inc 2 sets of wireless headphones and one USB in second row) with 8" screens	129AH	\$3,240	\$3,240	■	–	–	■	–	–
Rear seat entertainment system with remote control (inc 2 sets of wireless headphones and one USB in second row) with 10.2" screens	129AQ	–	–	\$1,950	■	■	\$1,950	■	■

OPTION PACKS

	CODE	TDV6 VOGUE	SDV8 VOGUE	SDV8 VOGUE SE	SDV8 AUTO-BIOGRAPHY	SDV8 AUTO-BIOGRAPHY BLACK	V8 S/C VOGUE SE	V8 S/C AUTO-BIOGRAPHY	V8 S/C AUTO-BIOGRAPHY BLACK
Pack 12 (P12) – Parking pack Park Assist – Parallel Parking/Parking Exit/Perpendicular parking/360° Park Distance Control & Lane Departure Warning	086JA	\$4,360	\$4,360	■	■	\$4,360	■	■	\$4,360
Black Design Pack Santorini Gloss Black Mirror Caps, Exterior Accents, Range Rover script on tailgate and bonnet, Bumper vanes, Front Grille, Toweye Cover, Tailgate lid finisher, Bonnet Finisher, Side Vent Graphic, Wheel Nuts	074LN	\$2,600	\$2,600	\$2,600	\$2,600	–	\$2,600	\$2,600	–

WARRANTY

A comprehensive manufacturer's warranty is a feature of every Land Rover vehicle and extends to any genuine Land Rover accessories fitted by a Land Rover Retailer. The warranty period for the vehicle is three years/100,000 kilometres. In addition, the paint surface is also covered for three years/100,000 kilometres and the body work covered for corrosion for six years.

LAND ROVER ROADSIDE ASSISTANCE

All Land Rover vehicles purchased in Australia benefit from complimentary Land Rover Roadside Assistance service for the length of the new car warranty. This covers you Australia-wide 24 hours per day every day. And because it is Land Rover Assistance, help will also be provided if you become bogged or disabled on roads that only four-wheel drives can travel.

CUSTOMER CARE

Land Rover Australia has a dedicated Customer Care Centre to assist owners who may have a general query. Owners seeking this level of assistance are invited to phone our Customer Care Centre on the toll-free number 1800-625-642 or email enquiries@landrovercustomers.com.au. Land Rover ownership includes a package of benefits designed to provide high standards of after sales care and support.

LAND ROVER FINANCIAL SERVICES

Just as Land Rover lets you tailor a vehicle to your specific requirements, we offer you the same service when it comes to finance. You can arrange to purchase and finance your Land Rover from the people who know it best – your Land Rover Dealer. Your Land Rover Business Manager can explain the full range of finance options available from Land Rover Financial Services and provide expert advice to help tailor a finance package to best suit your needs. To discover more about Land Rover Financial Services visit your nearest Land Rover Dealer, call 1300 555 211 or visit www.landrover.com.au for more information.

Land Rover Finance is provided by St. George Finance Limited (ABN 99 001 094 471) Australian Credit Licence 387944 to approved customers only. Credit criteria, fees, charges and terms and conditions apply.

LAND ROVER ASSURED EXTENDED WARRANTY

Choose Land Rover Assured Extended Warranty Insurance for 12 or 24 months, up to 200,000 kilometres. Land Rover Assured Extended Warranty Insurance lets you enjoy your Land Rover both on and off the road without any concerns of the cost and inconvenience of mechanical failure. For a once off payment, you can enjoy the reassurance of protection against mechanical failures for up to 24 months with qualified repairs for the life of your warranty. Consult your Land Rover Retailer for more information.

The Bluetooth® word mark and logos are owned by the Bluetooth SIG, Inc. and any use of such marks by Land Rover is under license.

Important Notices:

All details in this Recommended Retail Price list are believed to be correct as of September 2014. However, we are constantly striving for improvement and therefore reserve the right to alter price and specifications without notice. Distributors and retailers are not agents of Land Rover Australia and have no authority to bind Land Rover Australia to any expressed or implied undertaking or representation.

For further pricing information contact your local Land Rover dealer or go to the Driveaway Pricing Calculator at www.landrover.com.au

Jaguar Land Rover Australia Pty Ltd
Trading as Land Rover Australia ABN 86 004 352 238
65 Epping Road, North Ryde NSW 2113
Locked Bag 2214, North Ryde NSW 1670
©Jaguar Land Rover Australia Pty Ltd 2014
Publication Number LR9665 Range Rover 10/14 Consumer



ABOVE AND BEYOND