



**EVORA**



# LOTUS EVORA

# CONTENTS



---

A UNIQUE PLACE IN <b>HISTORY</b>	4-5
LOTUS RACING <b>ON TRACK</b>	6-7
FUN FOR SERIOUS <b>DRIVERS</b>	8-9
PERFORMANCE <b>FOUNDATIONS</b>	10-11
EVOLVED ON <b>TRACK</b>	12-13
EXCITING ON THE <b>ROAD</b>	14-15
INTELLIGENCE IN THE <b>CITY</b>	16-17
THE LOTUS <b>EVORA</b>	20-21
THE LOTUS <b>EVORA S</b>	22-23
THE LOTUS <b>EVORA SPORTS RACER</b>	24-25
FEATURE <b>FOCUS</b>	26-27
COCKPIT <b>INTERIOR</b>	28-29
ROAD PROVEN <b>RACE PERFECT</b>	30-31
BODY <b>COLOURS</b>	34-35
INTERIOR <b>STYLE</b>	36-37
EXTERIOR <b>WHEELS</b>	38
OPTION <b>PACKS</b>	39
TECHNICAL <b>SPECIFICATION</b>	40-42
LOTUS <b>LIFE</b>	43
FURTHER <b>INFORMATION</b>	44



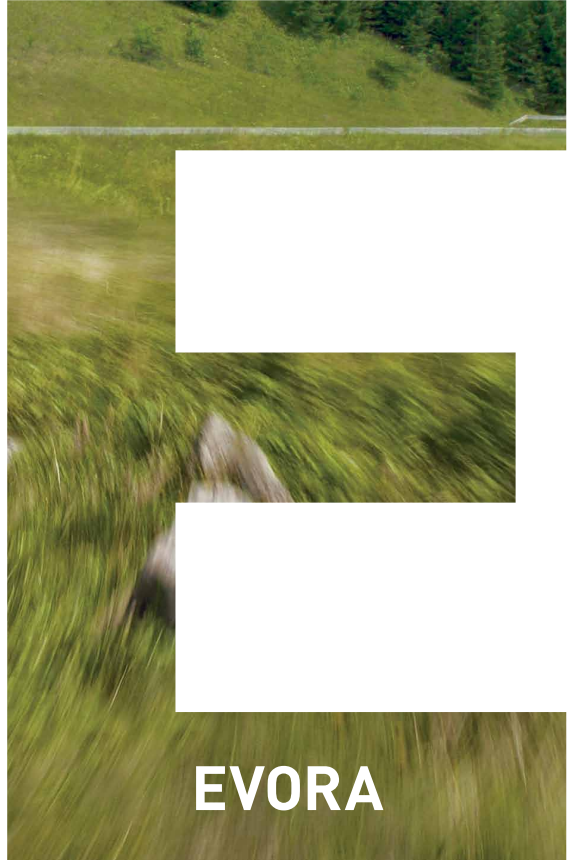

**EVORA**



FIA Formula 1  
Constructors'  
World  
Championships



FIA Formula 1  
Drivers'  
World  
Championships



FIA Formula 1  
Grand Prix  
Wins



Le Mans  
Wins  
(in Class)



Indianapolis 500  
Win



FIA World Rally  
Championship

“If you’re not winning, you’re not trying.”

*Colin Chapman*

# A UNIQUE PLACE IN HISTORY



Lotus is a driving icon that throughout decades of development has remained true to its founding principles; from the original Elite to the latest Evora. Efficient use of the minimum number of parts, a perfectly balanced chassis and a tactile and involving spirit are recognisable in every car to carry the Lotus badge.

In 1948 Colin Chapman built his first car, following his own theories for improved performance. He formed Lotus in 1952 and from then on the company has never ceased to innovate. In competition, Lotus has a rich history. In Formula 1 alone Lotus has more than 500 Grand Prix starts, complete with 81 victories and 7 World Championships. In addition to the accolades gained in F1, Lotus has successfully competed in Rally, Le Mans, Indy and sports car classes around the world.

Chapman was a pioneer in creating lightweight cars, his innovations changed the face of racing car design forever. From the introduction of 'ground effect', aerofoil wings, monocoque chassis and active-ride suspension through to the aluminium bonded chassis of the modern line up, Lotus have never stopped inventing and the passion for innovation remains at the core of everything they do today.



**Above:** Founder Colin Chapman.  
**Left:** 1970, the British Grand Prix was won by Rindt's Lotus 72.  
**Right:** 1972, Fittipaldi in the iconic black and gold livery debriefs Chapman.

# LOTUS RACING ON TRACK



---

**Left:** Evora GT4  
**Below:** LMP2 Car  
**Bottom:** 2012 MSA British Endurance  
Championship winning Evora GTC  
**Right:** Lotus F1® Team Cars at the 2013  
German Grand Prix

---



For Lotus, motorsport is tradition, inspiration and the cornerstone of its brand. Colin Chapman inspired Lotus' racing success and applied his engineering genius to make Lotus cars technically innovative and ultimately faster than the competition.

As ambitious now as in the past, this dedication to motorsport continues with Lotus gearing up in competitions around the world. In Formula 1®, Endurance racing and numerous GT series, Lotus is up to speed; from Silverstone to Le Mans to Laguna Seca, Lotus is making an impression in the world's most famous events on the most demanding circuits. These high-profile international events are complimented by dedicated Lotus one-make race series for the Evora, Exige and Elise.

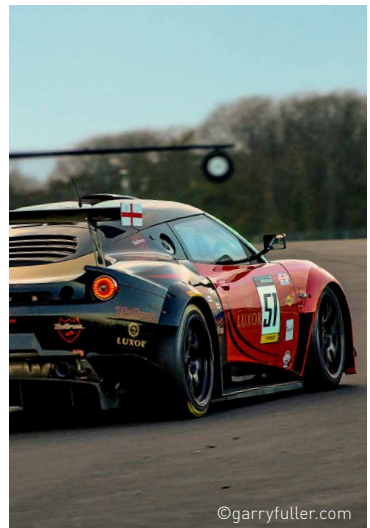

©garryfuller.com







**E**  
EVORA



**Es**  
EVORA



**EGT4**  
EVORA



**EGTC**  
EVORA

# FUN FOR SERIOUS DRIVERS



Like all Lotus' before it, the Evora is a sports car that benefits from a unique approach to driving dynamics.

The Evora is a car for serious drivers who enjoy the combination of performance and the open road. Its design and engineering technology ensure that the driver is fully immersed in a sensory experience, where exactly the right feedback is transmitted from the road to make even the most ordinary drive feel special.

Lotus' engineering and racing expertise has ensured the development of a sports car that lends itself to excellence on both road and track, as witnessed through its evolution. In race form, the Evora GT4 encapsulates all of Lotus' core values and technical expertise, it's a proven winner. Its long-distance derivatives have shown their pace in numerous endurance series including the Le Mans 24-Hours, the American Le Mans Series and the MSA British Endurance Championship.

For handling, performance, exquisite poise and usability, the Lotus Evora delivers in every aspect.

# PERFORMANCE FOUNDATIONS

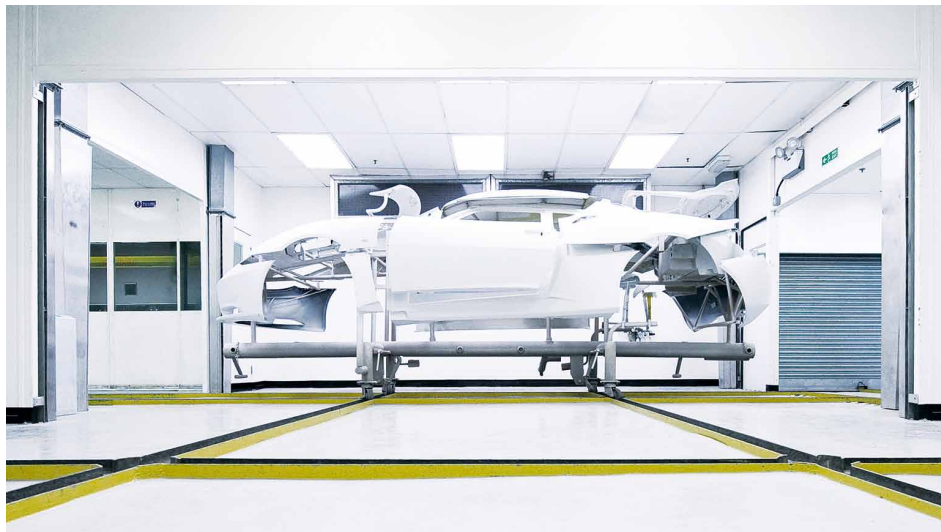

The essence of the Evora is found in its exceptional engineering and focus on performance. Production combines high technology processes with hand finishing techniques, from chassis construction through to final assembly. Teams of specialists oversee every process ensuring Lotus' high-quality engineering standards are met during every stage of the build; with completed cars undergoing rigorous rolling road and water-ingress tests to ensure ultimate reliability and performance.



The state-of-the-art Evora chassis is composed of an extruded and bonded aluminium structure, developed for its lightweight yet incredibly stiff design, with a central tub containing the driver's cockpit and safety cell - a format closely reflecting the layout and construction of modern-day racing cars. Its unique design ensures a chassis so stiff that it takes 27,000 Nm to twist it just one degree.

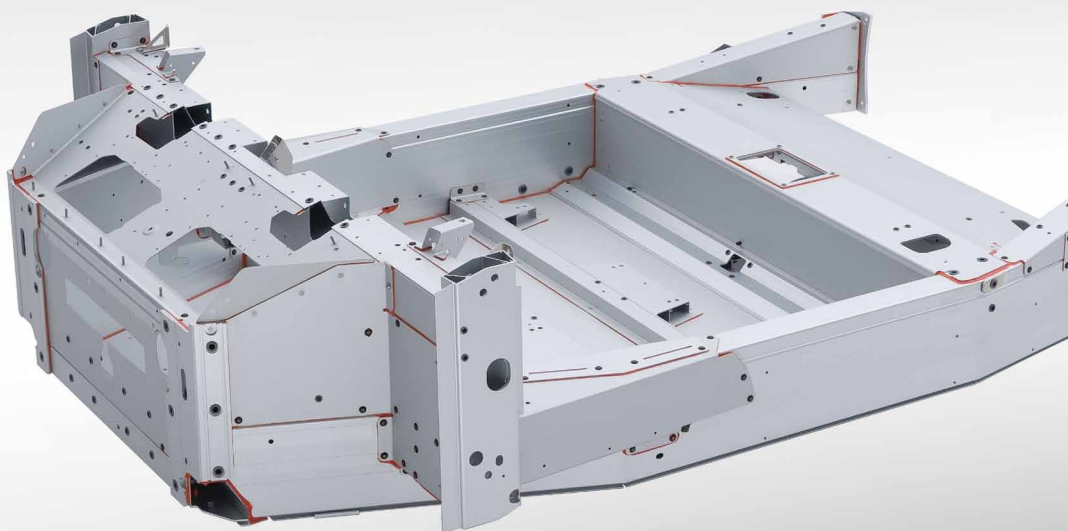

This chassis strength allows Lotus engineers to tune the motorsport derived double wishbone suspension for more compliance, increasing comfort without compromising the exceptional ride and handling dynamics.

# EVOLVED ON TRACK

With its state-of-the-art, lightweight chassis, the Evora's handling is truly remarkable. From its functional aerodynamics, to its mid-engined construction giving optimum weight distribution, through to its race-derived components, such as Bilstein dampers, Eibach springs and AP Racing track tuned braking system - Lotus' motorsport expertise feature in its design and engineering.



Whether it's an occasional track day or a full-on assault in endurance racing with a GT4, the Evora's track evolved origins are plain to see, with its dynamic capabilities honed on some of the world's most demanding test facilities, including the famous Hethel test track.

Focussed driving is effortless with the sticky Pirelli tyres providing amazing grip, tucking the nose into apexes with precision and poise. As the twisting tarmac disappears beneath you, this Lotus sports car makes light work of the road ahead.









# EXCITING ON THE ROAD



Whatever the circumstances - graceful curve, hairpin or sweeping straight, the Evora rises to all occasions. A low-drag, elegant fastback design combine with fluid lines, a swept-forward cabin and aggressive poise, giving subtle cues to its sporting attitude.

With perfectly weighted power-assisted steering, it displays total fluency and agility on the road. And, like no other sports car in its class, it transmits that directly to the driver via extra sensory feedback. Its highly tuned suspension ensures it tracks accurately through corners, soaking up bumps and smoothing out changing surfaces along the way. Its cross-drilled and ventilated four-piston caliper disc brakes are unparalleled, effortlessly bringing the car to a standstill whenever called upon, without the slightest hesitation or fade.

Increasing the Evora's fabulous performance arsenal is the Dynamic Performance Management (DPM) traction and stability management system. It has three settings; suppressing oversteer and understeer when fully on, allowing a small degree of slip in 'Sport' to provide the driver greater engagement, and disengaging altogether in 'off' when you want to test your reflexes. Serious fun for serious drivers.

# INTELLIGENCE IN THE CITY

Transitioning from open-road to urban jungle, the Evora is not fazed. Its compliant suspension makes light work of rough surfaces and bumps. With a commanding on-road presence, the Evora occupies the road with sporting appeal and a lack of fuss, providing an imposing yet unthreatening presence.

On the urban grind there is plenty to entertain you including direct inputs for iPod®, iPhone® and MP3 devices via the optional multi-media system with satellite navigation.

In fluctuating traffic conditions the 'IPS' (Intelligent Precision Shift) automatic version with paddle shift control provides a more relaxed driving mode thanks to its smooth power delivery and precise auto shifts.

The standard 2+0 seating configuration offers more than enough storage for a healthy dose of retail therapy. Alternatively, select the optional 2+2 configuration to ensure that even a school run is an exciting drive. The Evora is a Lotus that can be enjoyed on any occasion, anytime, anywhere.





# PULSE RACER





# THE LOTUS EVORA

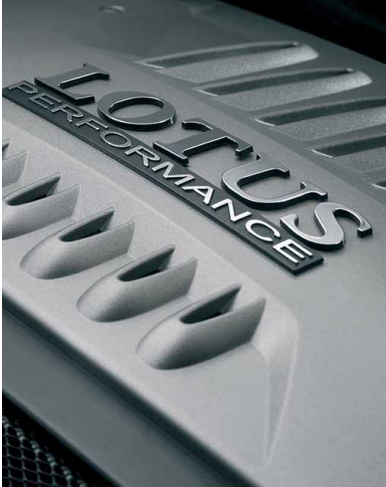

Potent performance and graceful design combine in the stunning Evora. Lotus engineers have married a 276 hp, 3.5 litre DOHC V6 VVT-i engine with a state-of-the-art, aluminium bonded chassis to provide the perfect blend of power and balanced handling.

Its stunning performance is accessed via a 6 speed manual transmission with perfect sports ratios that are matched to the engine configuration and chassis dynamics. For added flexibility, select the optional IPS (Intelligent Precision Shift) automatic transmission with paddle shift.

Supple, leather sports seats provide increased comfort, whilst giving the support needed by the more spirited driver. The optional 2+2 seating layout provides additional flexibility. The Evora is a Lotus designed to take you further, for longer, and in greater comfort than before without sacrificing Lotus' performance credentials.

<b>Max Power</b>	276 hp (280 PS) at 6400 rpm
<b>Max Torque</b>	258 lbft (350 Nm) at 4600 rpm
<b>0 – 60 mph</b>	4.8 seconds
<b>0 – 100 km/h</b>	5.0 seconds
<b>Max Speed</b>	163 mph (262 km/h)
<b>Weight</b>	1383 kg









# THE LOTUS EVORA S

The Evora S blends the sublime handling attributes of the Lotus Evora with the surging linear power of a supercharged V6 engine. Delivering even more attitude, the forced induction power plant delivers 345 hp and 295 lbft of torque. There's no appreciable weight gain: at 1,437 kg the Evora S is still lightweight, muscling from 0 to 60 mph in 4.4 seconds, powering to its 178 mph maximum.

It's a logical progression. Forced induction brings instantaneous power delivery. It drives with an awe-inspiring urgency and vigour yet the remarkable Lotus chassis takes power and control in its stride.

Visual differences include an aggressive rear diffuser, black wing mirror caps and rear light surrounds, with a new active exhaust system providing a dramatic aural soundtrack.

With the Sport Pack as standard, the Evora S changes personality again. Increase throttle response, raise the rev limit and alter the Lotus DPM settings at the touch of a button for a heightened dynamic experience. This is pure Evora performance at its finest.



**Above:** Harrop HTV 1320 supercharger with Eaton TVS™ technology



<b>Max Power</b>	345 hp (350 PS) at 7000 rpm
<b>Max Torque</b>	295 lbft (400 Nm) at 4500 rpm
<b>0 – 60 mph</b>	4.4 seconds
<b>0 – 100 km/h</b>	4.6 seconds
<b>Max Speed</b>	178 mph (286 km/h)
<b>Weight</b>	1437 kg

# THE LOTUS EVORA SPORTS RACER



Enter the Evora Sports Racer; a visually enhanced and optimised version of this award winning, mid engine supercar, available in both naturally aspirated and supercharged 'S' variants. The Sports Racer sets itself apart through its unique styling, an ultimate specification with fully loaded options, and a lightweight price tag making it more affordable than ever.

Four exterior colour options coordinate with contrasting accents of black across the roof, front splitter, side sills and rear diffuser, exaggerating the Evora's aggressive stance, with the final touches including black name badges and a Union Jack side badge, paying homage to Lotus' heritage.

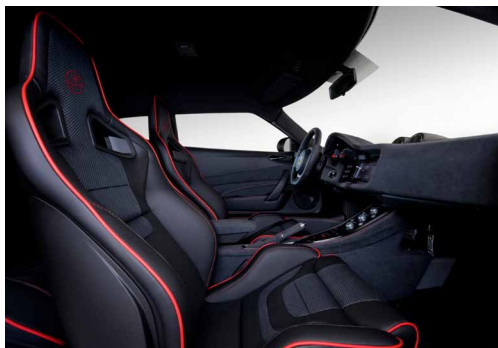

## STANDARD FEATURES

---

Paint options: Aspen White, Carbon Grey, Nightfall Blue, Ardent Red

---

Black accents: Roof, side mirror pods, front splitter, side sills, rear diffuser, light bezels, name badges

---

Union Jack side marker badge

---

Design wheel, gloss black, forged, (19" front and 20" rear) with Pirelli P-Zero Corsa tyres

---

Power-fold door mirrors

---

Reversing Camera

---

Black leather 'Premium Sport' seats with red contrast piping and stitching or Venom Red leather 'Premium Sport' seats with black contrast piping and stitching

---

Slate Grey SuedeTex® dashboard, doors and centre console with red contrast stitching

---

Gunmetal dashboard panels with black accents

---

2+2 seating configuration

---

Sport Pack

---

Tech Pack

---

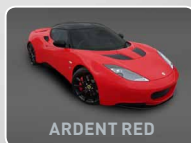

ARDENT RED



NIGHTFALL BLUE



ASPEN WHITE

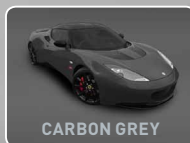

CARBON GREY

# FEATURE FOCUS



## 6 Speed Manual

Put yourself in complete control of the driving experience with the slick shifting 6 speed manual transmission, featuring sports ratios perfectly matched to the engine configuration and driving dynamics.



## 6 Speed IPS Automatic

Opt for the Intelligent Precision Shift (IPS) for an automatic gearbox option featuring Lotus transmission control. Select 'Drive' mode for smooth and relaxed automatic shifting or for spirited driving engage the steering wheel mounted paddles for finger tip control.



## Dynamic Performance Management

Lotus DPM (Dynamic Performance Management) adds to the Evora's safety features by offering extra stability when the high levels of grip are exceeded. A selectable Sport mode takes DPM one step further, allowing the driver to safely explore the limits even more.



## Bi-Xenon Headlamps and LED Rear Lights

Distinctive headlamps incorporate Bi-Xenon lights as standard, offering exceptional night time illumination, while the rear LED brake cluster is instantly recognisable.



### Rear Spoiler

The integrated boot spoiler on the Evora not only has a functional purpose but adds to the inspired styling of the car.



### Exhaust

A free flowing exhaust system features special bypass valve that opens at higher speeds to reduce the back pressure in the system, increasing the power output and producing a heightened exhaust note. With the Sport Pack fitted, the valves open with the press of the sport button.

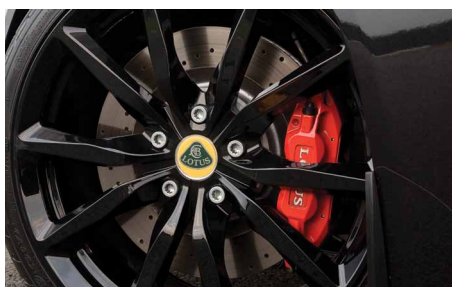

### Wheels and Tyres

Choose from a range of specially selected lightweight alloy wheels to subtly enhance the way your car looks and drives in either 18"/19" or 19"/20" diameter. These are mated to sticky Pirelli P-Zero or P-Zero Corsa tyres that work in perfect harmony with the suspension and chassis.



### Steering Wheel

Lotus Engineers pay attention to every detail. The ergonomically shaped steering wheel is made from lightweight magnesium, reducing the amount of inertia allowing you to quickly change direction with the least amount of effort.



# COCKPIT INTERIOR



It's better to travel than to arrive. Which is why the Evora interior combines comfort with function, blending sophisticated, high quality materials with precise attention to detail and superb craftsmanship. Machined aluminium features along with supple, hand trimmed and twin stitched leather. Sculpted, figure hugging Recaro seats leave nothing to distract you from the finer points of driving.

A Lotus command centre with auxiliary trip computer and an immobiliser with remote activated alarm are fitted as standard. The option list includes contemporary features such as an advanced touchscreen multi-media system with satellite navigation, MP3/iPod® connectivity and a reversing camera.

Other available options include electric power-fold mirrors, heated seats, and the practical 2+2 rear seat, which include ISOFIX® mountings for rear child seats, because even sports car enthusiasts have families.

# ROAD PROVEN RACE PERFECT



The Evora has evolved from Lotus' superb reputation for technical innovation and invention. It's a reputation that's well-deserved, built on an enviable history and a commitment to core principles of innovation, performance through light weight, and agility. The result: proven performance on both road and track.

With its class leading chassis design, handling and agility, the Evora personifies Lotus pedigree. Which is why it provides the perfect foundation for its high performance siblings.



---

**Top:** Evora Enduro  
**Middle:** Evora GT4  
**Top Right:** Evora GTC  
**Bottom Right:** Evora GTC interior

---





©garryfuller.com

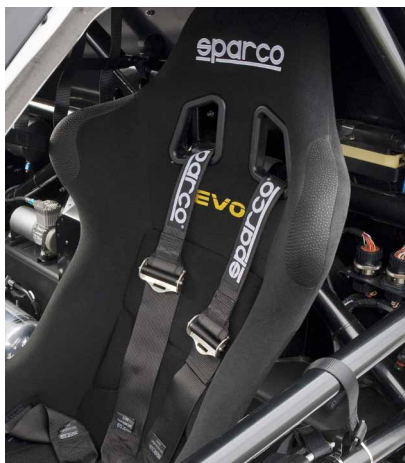

Presenting the class winning Evora GT4, it's long distance siblings the Evora Enduro GT and GTC Evora.

These race derivatives of the highly acclaimed road going Lotus Evora have been engineered to give drivers competitive racing packages straight 'out of the box'.

Developed by Lotus Racing in conjunction with prestigious technical partners, they feature FIA approved design and safety features and are accepted in many of the world's leading GT and endurance series.

For more information and specifications, please visit [www.lotuscars.com](http://www.lotuscars.com).

# URBAN JUNGLE





# BODY COLOURS

## STANDARD COLOURS

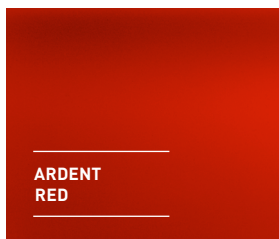

## METALLIC COLOURS

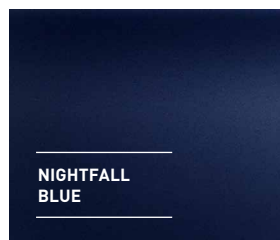
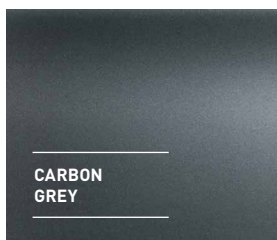
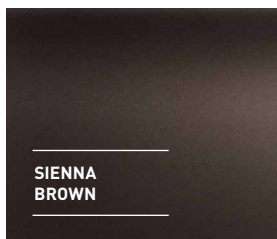

## MOTORSPORT COLOURS

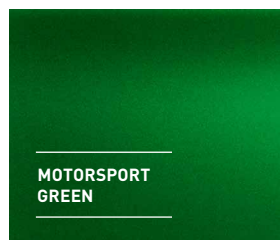

## PREMIUM COLOURS

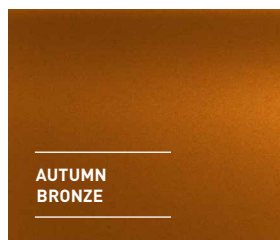
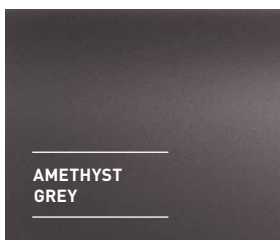
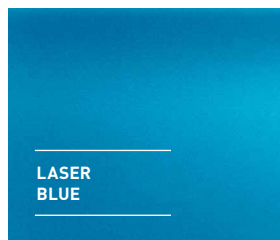
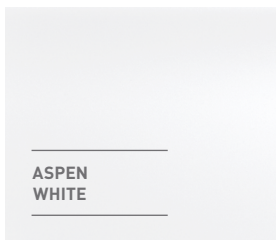
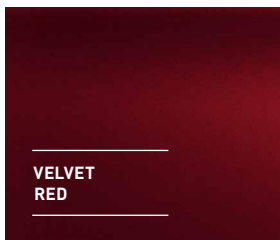

## SPORTS RACER COLOURS

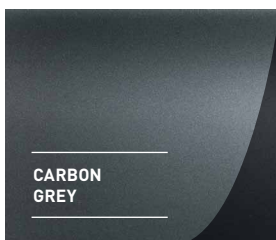
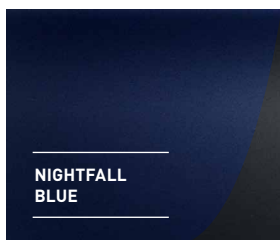
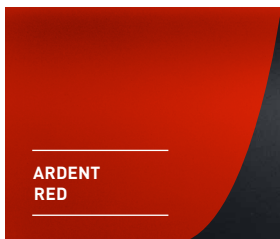

Out of range body colours such as previous Lotus colours, other manufacturer's special colours and 'match to sample' colours are available via the Lotus Bespoke service. Your Lotus dealer will be happy to advise on colours and price.

# INTERIOR STYLE

As with a bespoke suit from Savile Row, the Evora's interior can be tailored to the finest detail to satisfy your particular taste in upholstery and trim via three different Premium interior options.

Five different shades of leather are available in the Premium Pack to co-ordinate with sixteen exterior hues on the colour chart.

The Premium Pack SuedeTex® integrates ultra luxurious SuedeTex® with Ebony Black leather for a stylish and sophisticated combination.

The Premium Sport Pack, available in four colours, also incorporates contrasting colour stitching and piping on the seats and interior panels, the Lotus logo embroidered onto the headrests and carbon effect leather inserts on the seats.

Or opt for the standard specification featuring a combination of Ebony Black leather and hard wearing Charcoal cloth.

With so many Lotus fans having been inspired in their childhood, the Evora's cabin can be specified as a 2+2 with ISOFIX®, the international standard for anchoring child safety seats, to create a secure and entrancing environment for your younger passengers, or simply as a two-seater configuration, which makes for more storage space.



**STANDARD**



**PREMIUM PACK**



**PREMIUM PACK  
SPORT**



**PREMIUM PACK  
SUEDETEX®**

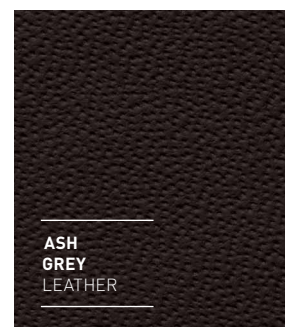
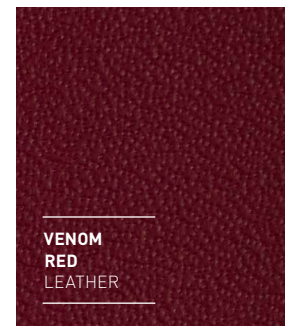
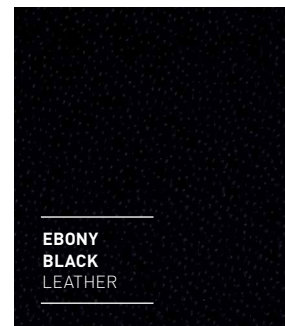

**Disclaimer:**  
Colour swatches are for illustration purposes only and may not accurately reflect the actual colour finish of the vehicle. Please consult your Lotus dealer for accurate colour samples.

# EXTERIOR WHEELS

If you have an enthusiasm for alloy wheels, then you'll be spoilt for choice with the Evora. Seven different options are available; Satin Gunmetal and Gloss Black 10-spoke Design Wheels in 19" and 20" diameter are the latest additions to the range.



**CLASSIC WHEEL  
SILVER, CAST**  
(18" FRONT AND 19" REAR)



**CLASSIC WHEEL  
STEALTH GREY, CAST**  
(18" FRONT AND 19" REAR)



**SPORT WHEEL  
SILVER, FORGED**  
(18" FRONT AND 19" REAR)



**SPORT WHEEL  
GLOSS ANTHRACITE, FORGED**  
(18" FRONT AND 19" REAR)



**DESIGN WHEEL  
DIAMOND CUT, FORGED**  
(19" FRONT AND 20" REAR)



**DESIGN WHEEL  
SATIN GUNMETAL, FORGED**  
(19" FRONT AND 20" REAR)



**DESIGN WHEEL  
GLOSS BLACK, FORGED**  
(19" FRONT AND 20" REAR)

# OPTION PACKS

## ALL PREMIUM PACKS INCLUDE:

- Accent lighting
- Leather trimmed door pockets
- Armrest
- Leather footwell side panels
- Leather tailgate insert panel

## PREMIUM PACK

- Leather centre console
- Leather door panelling below trim band
- Choice of leather colours: Ebony Black, Venom Red, Ivory White, Ash Grey, Cognac Brown, includes leather rear seats (2+2 option only)

## PREMIUM PACK SUEDETEX®

- Slate Grey SuedeTex® centre console
- SuedeTex® trim band and lower door panelling
- Ebony Black leather and SuedeTex® seat combination (front and rear on 2+2)

## PREMIUM PACK SPORT

- Leather centre console
- Carbon effect leather inserts on the seats
- Leather door panelling below trim band
- Choice of leather colour: Ebony Black with red contrast stitching and piping, or Venom Red with black contrast stitching and piping, includes leather rear seats (2+2 option only)

## SUEDETEX® TRIM PACK

- Gear gaiter
- Handbrake sleeve
- Handbrake gaiter
- Door handle inner
- Door pocket

## TECH PACK

- Upgraded stereo system with 2x50W amplifier, upgraded speakers and additional subwoofer with dedicated amplifier
- DVD player
- 6.1" WVGA touch screen display with integrated satellite navigation
- Bluetooth™ mobile phone connection
- USB connection for various iPod® models MP3 players and memory sticks
- Tyre pressure monitoring
- Cruise control
- Rear parking sensors
- HomeLink®

## SPORT PACK (Standard on S)

- Switchable sports mode with sharper throttle response (standard with IPS)
- Increased RPM limit and sportier setting for Dynamic Performance Management (DPM)
- Sports diffuser (uprated Evora S diffuser remains unchanged)
- Titanium sports exhaust tailpipe (stainless steel on Evora S)
- Cross-drilled brake discs
- Red painted brake calipers (black is a no-cost option)

# TECHNICAL SPECIFICATION

## ENGINE

All alloy, 3.5 litre DOHC V6 VVT-i, 24-valve  
Evora S equipped with Harrop HTV 1320 Supercharger utilising Eaton TVS™ Technology  
Mid mounted, transverse, rear wheel drive  
Multi-point sequential fuel injection and direct ignition system  
Lotus Electronic Throttle Control system

## TRANSMISSION

6 speed manual with sports ratios  
6 speed automatic with Intelligent Precision Shift (IPS)  
BOSCH Electronic Differential Lock (EDL)

## CHASSIS / BODY

Two-door coupe bodystyle with 2+0 or optional 2+2 seating  
Lightweight, extruded aluminium bonded structure  
Composite body panels  
Aerodynamically optimised rear diffuser and wing  
Bi-Xenon headlights with integrated direction indicators  
LED rear lamps with integrated direction indicators  
Body coloured, electric door mirrors (black on Evora S)

## SUSPENSION

Independent forged aluminium double wishbone suspension with anti-roll bars, front and rear  
Bilstein high performance gas dampers, front and rear  
Eibach coaxial coil springs, front and rear

## STEERING

Rack and pinion, Lotus tuned hydraulically-assisted power steering  
Steering column adjustment for height and rake

## BRAKING AND DYNAMIC SYSTEM

AP Racing 4-piston calipers, front and rear  
Servo assisted ventilated discs, 350 mm front, 332 mm rear (cross drilled if Sport Pack fitted)  
Lotus/BOSCH tuned ABS system  
Hydraulic Brake Assist (HBA)  
Electronic Brake Distribution (EBD)  
Cornering Brake Control (CBC)  
Lotus Dynamic Performance Management (Lotus DPM)

## WHEELS & TYRES

Classic wheels, cast alloy, 18" front and 19" rear  
Front Pirelli P-Zero 225/40 ZR18  
Rear Pirelli P-Zero 255/35 ZR19

## INTERIOR SPECIFICATION

Adjustable Recaro leather sports front seats  
Flat bottomed magnesium steering wheel trimmed in leather  
Dual stage driver and passenger airbags  
Passenger airbag on/off switch (non-federal markets)  
ISOFIX® child seat anchorage (LATCH system in federal markets) with 2+2 option  
Bespoke aluminium illuminated control knobs and switches  
Door storage bins and integrated cup holders  
Lotus command centre with auxiliary trip computer and vehicle monitoring displays  
Alpine CD/MP3/WMA receiver with integrated iPod® connectivity  
Immobiliser and remote activated alarm  
Remote central locking with boot release  
Air conditioning



## OPTION PACKS

Sport Pack
Premium Pack
Premium Pack Suedetex®
Premium Pack Sport
Tech Pack

## ADDITIONAL OPTIONS

2+2 seat configuration
6 speed automatic Intelligent Precision Shift (IPS)
Metallic paint
Premium paint
Motorsport paint
Power-fold door mirrors
Body coloured door mirrors (no cost option on Evora S)
Reversing Camera (only with Tech Pack)
Heated front seats (standard with Premium Pack)
Classic wheel, stealth grey, cast alloy, 18" front and 19" rear (standard on Evora S)
Sport wheel, silver or gloss anthracite, forged alloy, 18" front and 19" rear
Design wheel, diamond cut, satin gunmetal or gloss black, forged alloy, 19" front and 20" rear with Pirelli P-Zero Corsa tyres, front 235/35 ZR19 and rear 275/35 ZR20

## PERFORMANCE

	EVORA MANUAL / IPS	EVORA S MANUAL / IPS
Max power	276 hp at 6400 rpm (280 PS) (206 kW)	345 hp at 7000 rpm (350 PS) (258 kW)
Max torque	258 lbft at 4600 rpm (350 Nm)	295 lbft at 4500 rpm (400 Nm)
0-60 mph (seconds)	4.8 / 5.0	4.4 / 4.5
0-100 km/h (seconds)	5.0 / 5.2	4.6 / 4.7
Max speed (mph (km/h))	163 (262) / 159 (256)	178 (286) / 167 (269)
Power to weight ratio		
Hp per tonne	200 / 192	240 / 239
PS per 1000 kg	203 / 195	244 / 243

## DIMENSIONS / AERODYNAMICS

	EVORA MANUAL / IPS	EVORA S MANUAL / IPS
Length	4350 mm	4361 mm
Width including mirrors	2047 mm	2047 mm
Height	1229 mm	1229 mm
Wheelbase	2575 mm	2575 mm
Unladen vehicle mass	1383 kg / 1436 kg	1437 kg / 1442 kg
Fuel tank capacity	60 litres	60 litres
Coefficient	0.33	0.33

FUEL CONSUMPTION (MPG (L/100KM))	EVORA		EVORA S	
	MANUAL / IPS		MANUAL / IPS	
Urban	21.5 (13.2) / 21.2 (13.3)		19.9 (14.2) / 19.6 (14.4)	
Extra Urban	39.6 (7.1) / 42.8 (6.6)		37.7 (7.5) / 40.8 (6.9)	
Combined	30.3 (9.3) / 31.4 (9.0)		28.7 (9.9) / 29.3 (9.7)	
CO <sub>2</sub> emissions (g/km)	217 / 210		229 / 224	



# LOTUS LIFE

## LOTUS DRIVING ACADEMY

Explore the capabilities of a Lotus at the famous Lotus Driving Academy. Developed for Lotus drivers of today and tomorrow, you can hone your skills behind the wheel under the guidance of professional instructors, maximising your driving enjoyment in a controlled, fun environment.

[www.lotusdrivingacademy.com](http://www.lotusdrivingacademy.com)



## LOTUS ORIGINALS

Excellence in development, dedicated craftsmanship and love of detail are all true hallmarks of the Lotus brand and we are now transferring them to the development of our exciting new lifestyle range.

Welcome to Lotus Originals, a collection perfectly reflecting the best of British understatement, authenticity, racing heritage, excellence on design, quality, engineering as well as innovation. Presenting our exciting new lifestyle collection with apparel, clothing accessories, leather items, luxury desk accessories and business gift ideas. Browse our latest collection and find exactly what you're looking for at [www.lotusoriginals.com](http://www.lotusoriginals.com)

# FURTHER INFORMATION

The information and images in this brochure are based on the current technical data when going to print. As part of a policy of continuous specification improvements, Lotus reserves the right to modify specifications, technical equipment, options and colours at any time. For the latest details please contact your authorised Lotus dealership or visit [lotuscars.com](http://lotuscars.com).

Throughout this brochure, wherever a feature is described as an option it should be assumed that it will be at extra cost to the base vehicle unless specifically stated to the contrary. All model and colour combinations are subject to availability. Certain options or combinations of options may be unavailable in certain markets.

Performance results may vary depending upon the specification of the particular vehicle, environmental conditions, driving style and other factors. Published figures should be used for COMPARISON PURPOSES ONLY AND VERIFICATION SHOULD NOT BE ATTEMPTED ON PUBLIC ROADS. Lotus recommends that all local speed and safety laws must be obeyed and safety belts worn at all times. The Evora and Evora S are intended for use as road going passenger vehicles. **THEY ARE NOT DESIGNED OR INTENDED FOR USE OFF ROAD, INCLUDING ON CLOSED CIRCUIT TRACKS OR FOR USE IN A COMPETITIVE MANNER, INCLUDING TIMED LAPS OR RUNS. ANY SUCH USE WILL INVALIDATE THE NEW VEHICLE WARRANTY.**

The previous general information applies equally to the Evora GT race cars in relation to road and for race use. Customers are responsible for ensuring that their cars comply with all relevant road, track and or race regulations at all times. **CARS INTENDED FOR TRACK USE ONLY CARRY NO MANUFACTURER'S WARRANTY OTHER THAN THAT REQUIRED BY LAW.**

The Evora GT race cars are intended for use on private property tracks only and are not suitable for use on the public highways. Their use on the public highway may constitute a criminal offence.

Use of any vehicle on track or in a competitive manner requires appropriate levels of expert vehicle preparation and servicing. Distributors and dealerships are not agents of Lotus and have absolutely no authority to bind Lotus by any express or implied undertaking or representation. All vehicles should be purchased through an authorised Lotus dealership, please see the dealer locator at [lotuscars.com](http://lotuscars.com). **PURCHASER'S STATUTORY RIGHTS ARE NOT AFFECTED.**

Note that current print and photographic techniques do not allow us to faithfully reproduce the full depth and tone of the colours in this brochure. This brochure is designed to provide general product information and is not a contractual document or offer of sale. For current information please contact your authorised Lotus dealership. The details in this brochure cannot be reproduced without the express authorisation of Lotus.

© Group Lotus plc 2013.



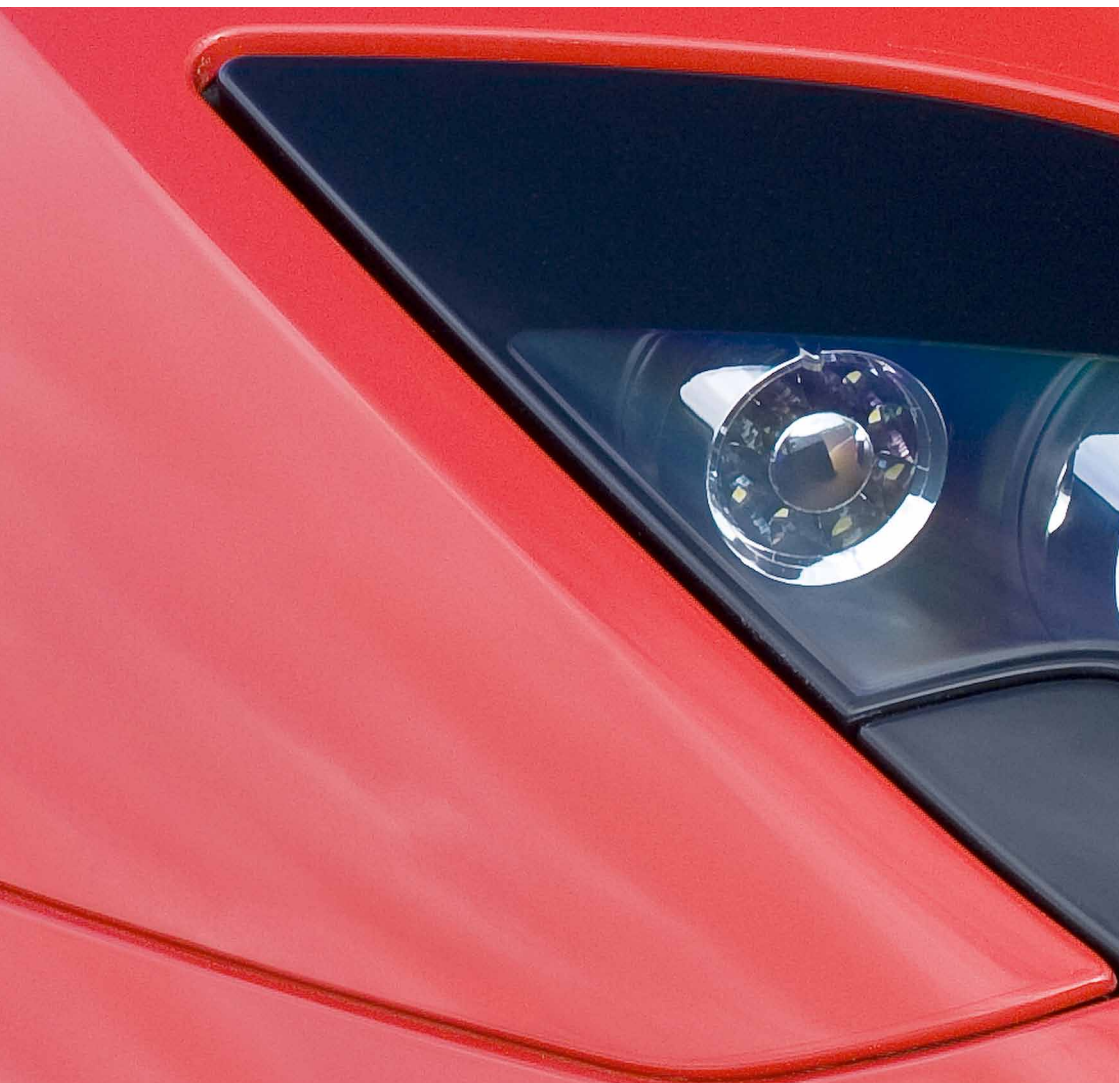

For further information on the Lotus range,  
to find your nearest dealer, or to arrange  
a test drive, please visit our website.  
**LOTUSCARS.COM**