

# *MAZDA MX-5*



mazda













*zoom-zoom*



*IMAGINATION DRIVES US*



1.5L Roadster GT in Soul Red Metallic.

	<b>2</b> INTRODUCTION		<b>14</b> CONNECTIVITY
	<b>4</b> ALL-NEW MAZDA MX-5		<b>16</b> SAFETY
	<b>6</b> EXTERIOR		<b>18-24</b> MODELS
	<b>8</b> INTERIOR		<b>26</b> SPECIFICATIONS
	<b>10</b> DYNAMICS		<b>30</b> CONFIDENCE
	<b>12</b> PERFORMANCE & SKYACTIV TECHNOLOGY		<b>31</b> COLOUR & TRIM

# IMAGINATION **DRIVES** US

Imagination is the world's most valuable resource. It's our window to the future, because if we can imagine it, we can create it. Mazda is built on a foundation of imagination and ingenuity. It's the fuel behind all we create and achieve. It has given us SKYACTIV TECHNOLOGY, 'KODO – Soul of Motion' design and countless successes that once existed only in someone's imagination. These pages show how imagination is an integral part of our innovative cars.



1.5L Roadster GT in Soul Red Metallic.

## EXCITE **EVERY** SENSE

All-New Mazda MX-5 is Zoom-Zoom in its purest form. Lighter and more streamlined than ever, the new open-top MX-5 brings car and driver together in a renewed spirit of 'Jinba Ittai' - the philosophy of 'horse and rider as one.' There's never been a more authentic expression of 'KODO - Soul of Motion' design. The lean, muscular body conveys power ready to be unleashed, balanced by a low stance that anchors it to the road. The interior is designed to feel like an extension of the driver, with an uncluttered, driver-focused layout to keep their world in control.

Enhanced with SKYACTIV TECHNOLOGY, Mazda MX-5's reputation for driving pleasure is heightened even further, with agile handling that responds with breathtaking reflexes. With a 26-year heritage as the world's most popular lightweight sports car, All-New Mazda MX-5 excites every sense like only a true roadster can. The iconic Mazda MX-5 is back, and more exhilarating than ever.



1.5L Roadster GT in Soul Red Metallic.

魂動

KODO : SOUL of MOTION

## DESIGNED FOR THE DRIVER

All-New MX-5 captures Mazda's signature KODO design philosophy in its most exciting form, with every angle and contour ready for action. It's the epitome of the 'driver's car,' with every element carefully designed to evoke the feeling of being at one with the vehicle.

Lowered by hand with one simple action, the soft top glides seamlessly away from view for wind-in-the-hair exhilaration. When closed, the roof reinforces the striking shape of the vehicle, adding a more defined silhouette. Incorporating true sports car elements, its low stance conveys a striking road presence. The new body preserves the spirit of the previous three generations of Mazda MX-5, combined with a power and elegance that is only fully realised when it's complete with driver.



1.5L Roadster GT in Soul Red Metallic and black leather trim!



## CAR AND **DRIVER** BECOME ONE

The interior blends the boundaries between the inside and the outside of the vehicle. The sleek design promotes a greater sense of connection to the open air, and oneness between car and driver. Interior panels enveloping the driver feature exterior paintwork for a sport-luxe finish to the cockpit. Understated, quality finishes feature throughout the passenger cabin, with all controls intuitively positioned to surround the driver in symmetry for optimal driving position and comfort.

Everything about the uncluttered, driver-focused interior design has been considered to remove visual noise and maximise the driving pleasure of the authentic roadster experience.



1.5L Roadster GT in Soul Red Metallic.

## THE EVOLUTION OF **JINBA ITTAI**

Inspired by the Jinba Ittai philosophy of 'horse and rider as one,' the intuitive relationship between car and driver is felt in All-New Mazda MX-5's responsive handling. The new generation has experienced a significant weight loss, yet an increased sense of rigidity. An enhanced feeling of balance and control is a result of perfect 50:50 front-rear weight distribution. With a lowered centre of gravity and the engine brought closer to the vehicle's centre, you experience responsiveness and stability that makes for a supremely supple drive. All-New Mazda MX-5 is the purest embodiment of Jinba Ittai yet. The car becomes a true extension of the driver, responding with innate agility to every command.



1.5L Roadster GT in Soul Red Metallic.

Breakthrough SKYACTIV TECHNOLOGY is behind Mazda MX-5's exhilarating yet economical performance. The innovation is applied to every element of the vehicle, unlocking superior handling and better fuel efficiency.

## **SKYACTIV** TECHNOLOGY

### SKYACTIV-MT

The newly developed 6-speed SKYACTIV-MT manual transmission delivers a lively performance and superior fuel economy. As one of the world's lightest transmissions, it's helped keep Mazda MX-5's weight down.



### SKYACTIV-CHASSIS

The development of the Mazda MX-5 SKYACTIV-CHASSIS was focused on achieving superior handling and stability, with faithful responses in every driving situation. The vehicle's posture has been crafted for flawless cornering, acceleration and braking to engage in a harmonious conversation with the open road.



### SKYACTIV-G 1.5L

The new generation 1.5L SKYACTIV-G petrol engine features direct injection with a unique piston design to promote more effective fuel combustion - boosting power, fuel economy and lowering emissions. Unleashing powerful performance with the feel of a broad torque range, the redesigned engine block delivers powerful acceleration well into the high RPM range, with a compression ratio of 13.0:1 when running on high-octane fuel.



### SKYACTIV-G 2.0L\*

Developed to offer driving pleasure in all conditions, the SKYACTIV-G 2.0L engine delivers maximum torque with impressive fuel economy. The reduced weight and greater combustion efficiency means the driver gets an engine they can always count on in the high RPM range.



### SKYACTIV-BODY

The new Mazda MX-5 SKYACTIV-BODY is assembled with materials explicitly selected to keep it light, yet rigid. Constructed from a combination of ultra-high-tensile steel and high-strength aluminium, the body is designed with integrity to be strong without bulk.



UNLEASH **PURE** PERFORMANCE



## THE **CONTROL CENTRE** OF YOUR DRIVING UNIVERSE

**Multi-function commander control** Conveniently located between the driver and passenger, the multi-function commander allows safe operation of MZD Connect with minimal effort.

**MZD Connect (optional on 1.5L Roadster)** All-New Mazda MX-5 is equipped with MZD Connect, a customisable on-board connectivity system that makes it safer and easier to access your online world on the road. Link your smartphone<sup>2</sup> via Bluetooth® to access your music, contacts and social networks from a single screen. Program it with your favourite information for an even more streamlined experience. Up-to-date maps mean navigation is never an issue, so you can relax and enjoy the drive.

**Audio** In addition to the standard-equipment six-speaker configuration, Mazda MX-5 is also available with a premium nine-speaker Bose® sound system. Both configurations feature 45mm driver's side headrest speakers, with the Bose® audio system adding a subwoofer and headrest speakers for the passenger. Jointly developed with Bose®, the exclusive system is designed to produce stunning sound quality, even with the top down. The USB and Bluetooth® compatible unit also supports audio playback from iPods and other portable audio devices.



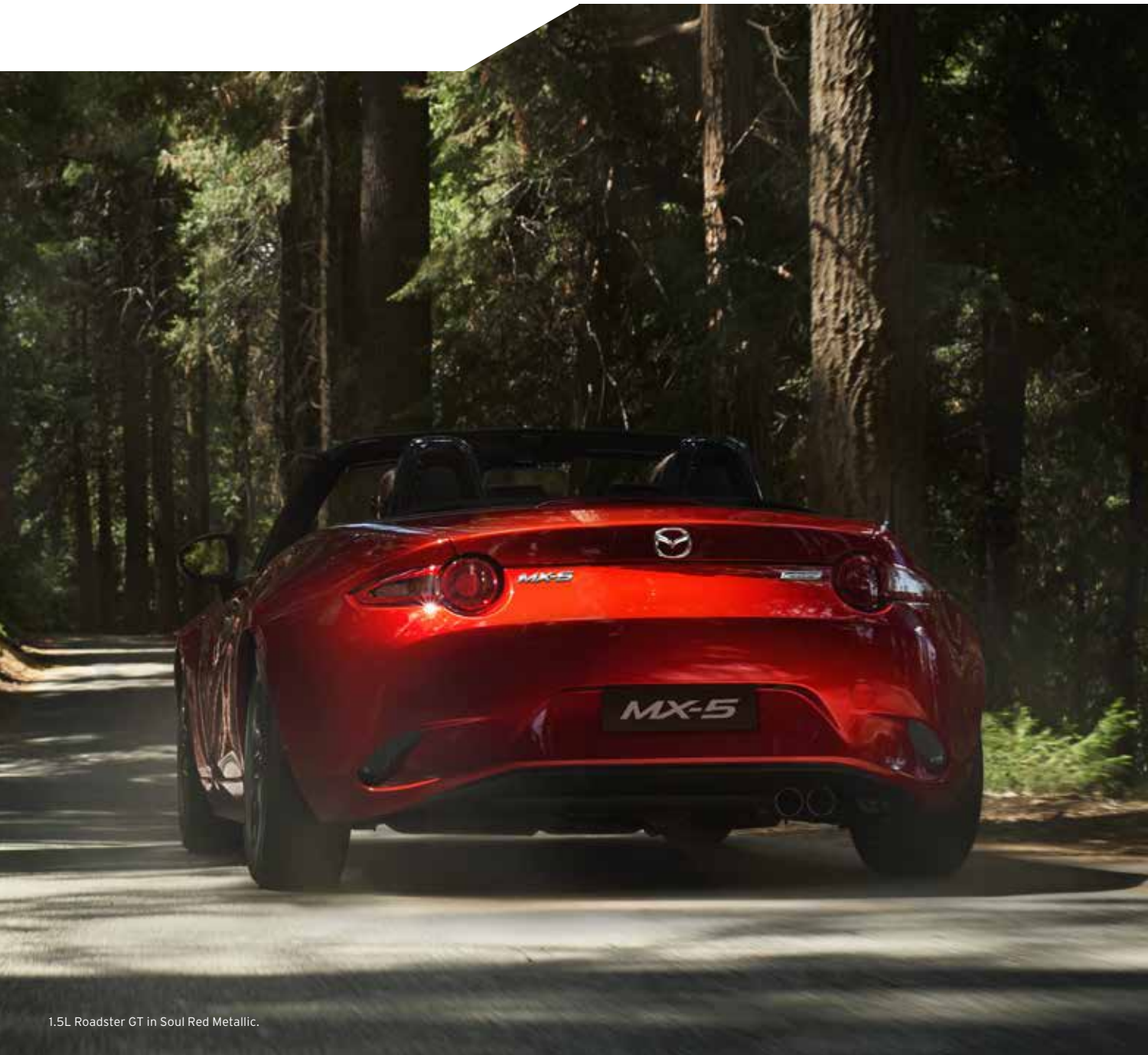

1.5L Roadster GT in Soul Red Metallic.

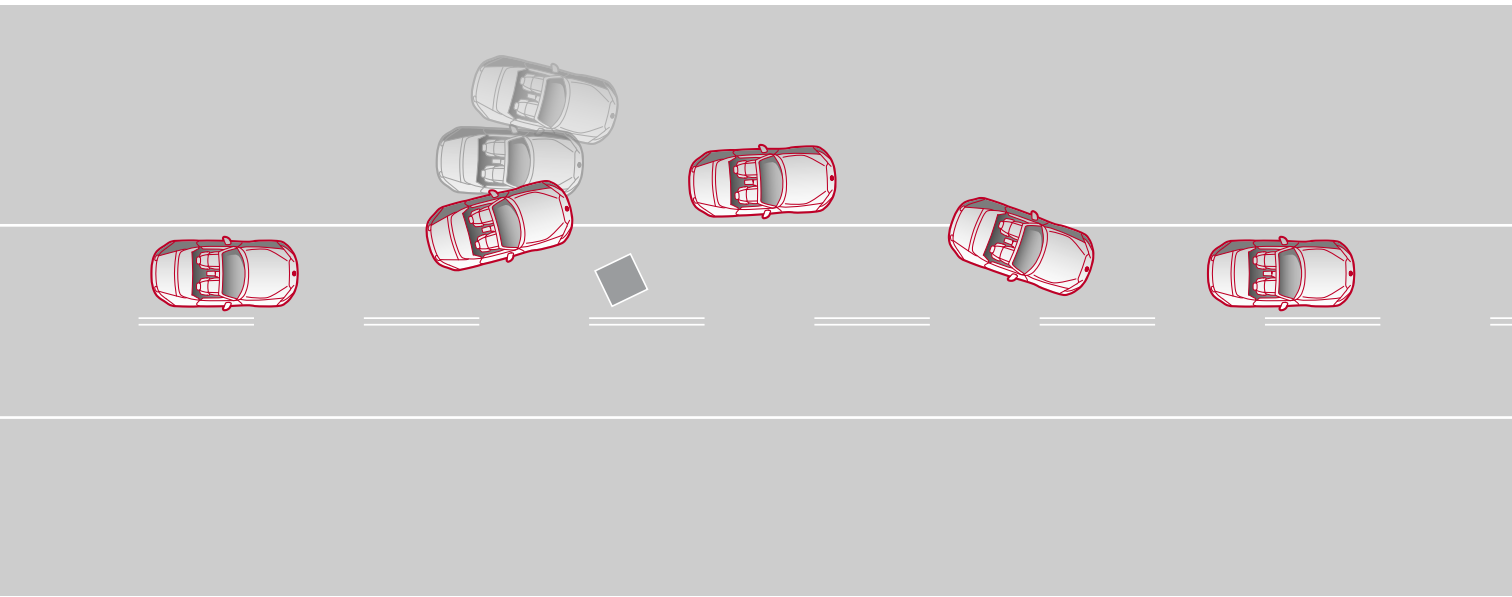

**SAFETY REFLEX**

Maintain control in an emergency braking situation with Dynamic Stability Control (DSC), which kicks in to assist steering. Traction Control System (TCS) limits skidding.

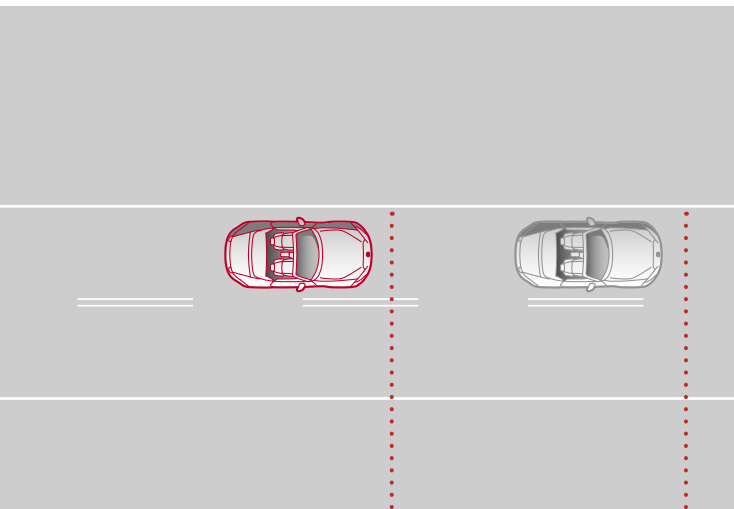

**BETTER BRAKING**

Stopping distance with  
EBA, ABS and EBD.

Stopping distance  
with no assistance.



**INCLINES MADE EASY**

Take your foot off the brake on a slope and Hill Launch Assist (HLA) will activate, keeping the brake on briefly and giving you time to apply the accelerator for a smooth take-off.

DRIVE WITH **CONFIDENCE**

Development of All-New Mazda MX-5 focused on creating an exhilarating drive, while also maximising safety and driver peace of mind. The high-strength SKYACTIV-BODY is engineered to minimise harm in the event of a collision. Front airbags for both passengers come as standard, and side-airbags with head-protecting cells safeguard against impact even with the top down.

ABS brakes feature Electronic Brake-force Distribution (EBD), which matches braking to vehicle load, while Emergency Brake Assist (EBA) boosts stopping power when emergency braking is sensed. An Emergency Stop Signal (ESS) activates the hazard lights to warn following drivers of sudden deceleration. Limited-Slip Differential (LSD) applies equal torque to both wheels, minimising wheel-spin (MT only). Armed with the latest in safety aids, you can enjoy every thrilling drive with confidence.

# 1.5L ROADSTER



1.5L Roadster in Crystal White Pearl Mica.



## 1.5L ROADSTER FEATURES INCLUDE:

- 16-inch alloy wheels with 195/50 tyres
- Cloth soft top
- Headlamps (LED)
- Power mirrors (body coloured)
- Seat trim: black cloth
- Air-conditioning
- Cruise control
- Leather-wrapped: steering wheel, handbrake handle and gearshift knob
- Audio system with: AM/FM tuner and 6 speakers
- Bluetooth® hands-free phone and audio capability<sup>2</sup>
- Advanced keyless push-button engine start
- Airbags SRS: front (driver and passenger) and side
- Emergency Stop Signal (ESS)
- Hill Launch Assist (HLA)
- Limited Slip Differential (MT only)
- Tyre Pressure Monitoring System (TPMS)

## MZD CONNECT OPTION:

- 7-inch touchscreen display (MZD Connect)
- Internet radio integration (Pandora®, Stitcher™ and Aha™)
- Multi-function commander control
- Satellite navigation

## POWERTRAIN:

- 1.5 litre in-line 4 cylinder 16 valve DOHC S-VT petrol (SKYACTIV-G) engine
- Fuel consumption (combined): 6.1l/100km<sup>3</sup> (manual) or 6.4 l/100km<sup>3</sup> (auto)
- Drivetrain: RWD
- Max power: 96kW @ 7,000rpm
- Max torque: 150Nm @ 4,800rpm
- Transmission: 6-speed manual (SKYACTIV-MT) or 6-speed auto



## SPORTING ALLURE

16-inch alloy wheels (silver) are the ultimate in stripped-back, functional beauty.

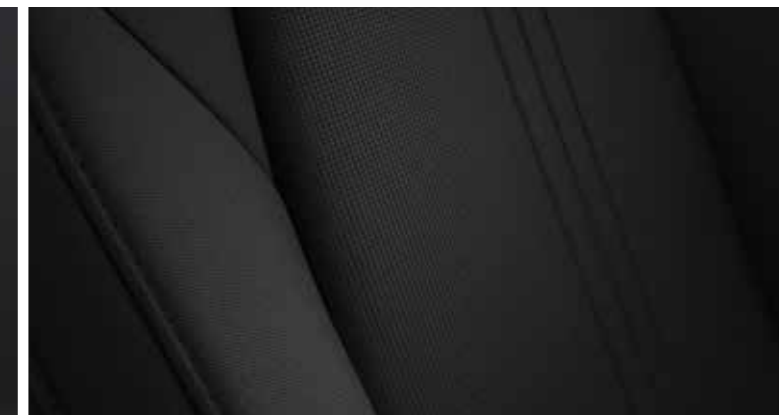

## PREMIUM TRIM

Black cloth seat trim created to suit open-top driving, with stitching to highlight each seat's rich curves.



## SUPERIOR SOUND

Audio system with AM/FM tuner and 6 speakers developed to deliver stunning sound quality, even with the top down.



## SET THE PACE

Cruise control maintains a consistent speed for a comfortable drive that can also save you fuel.

# 1.5L ROADSTER GT



1.5L Roadster GT in Soul Red Metallic.



### A SLEEK ADDITION

16-inch alloy wheels (gunmetal) with sleek, uncomplicated styling are made for performance first.

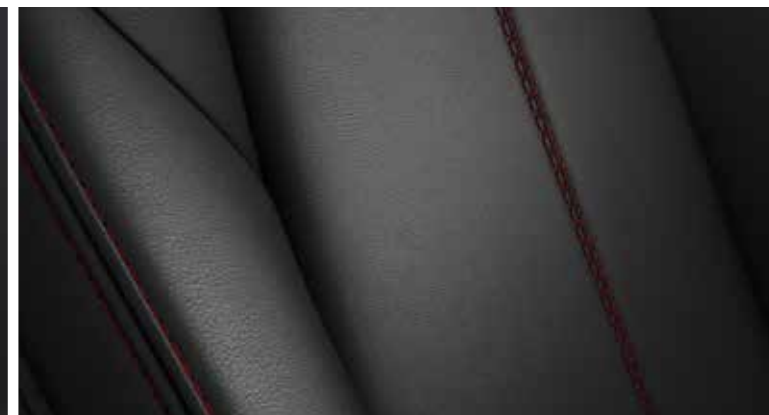

### CRAFTED FOR QUALITY

Black leather<sup>1</sup> seat trim adds cool elegance with quality craftsmanship and KODO diamond-shaped stitching.

### 1.5L ROADSTER GT FEATURES ADDITIONAL TO 1.5L ROADSTER INCLUDE:

- Daytime running lamps (LED)
- Headlamps auto on/off function
- Power mirrors (piano black with heating function)
- Rain-sensing wipers
- Seat trim: black or tan leather<sup>1</sup>
- Front seats with: heating function
- Rear-view mirror with auto dimming function
- Climate control air-conditioning
- 7-inch touchscreen display (MZD Connect)
- Internet radio integration (Pandora<sup>®</sup> Stitcher<sup>™</sup> and Aha<sup>™</sup>)
- Multi-function commander control
- Premium Bose<sup>®</sup> 203 watt amplifier with 9 speakers
- Satellite navigation
- Advanced keyless entry

### POWERTRAIN:

- 1.5 litre in-line 4 cylinder 16 valve DOHC S-VT petrol (SKYACTIV-G) engine
- Fuel consumption (combined): 6.1l/100km<sup>3</sup> (manual) or 6.4 l/100km<sup>3</sup> (auto)
- Drivetrain: RWD
- Max power: 96kW @ 7,000rpm
- Max torque: 150Nm @ 4,800rpm
- Transmission: 6-speed manual (SKYACTIV-MT) or 6-speed auto



### A PERFECT CABIN CLIMATE

Climate control air-conditioning maintains a comfortable environment, with temperatures adjusted to your preference.



### ALL AT YOUR FINGERTIPS

MZD Connect offers touchscreen connectivity and a large screen for easy viewing.

## 2.0L ROADSTER



2.0L Roadster in Blue Reflex Mica.



### 2.0L ROADSTER\* FEATURES INCLUDE:

- 17-inch alloy wheels with 205/45 tyres
- Cloth soft top
- Daytime running lamps (LED)
- Headlamps (LED)
- Power mirrors (piano black)
- Seat trim: black cloth
- Air-conditioning
- Cruise control
- Leather-wrapped: steering wheel, handbrake handle and gearshift knob
- Audio system with: AM/FM tuner and 6 speakers
- 7-inch touchscreen display (MZD Connect)
- Bluetooth® hands-free phone and audio capability<sup>2</sup>
- Internet radio integration (Pandora®, Stitcher™ and Aha™)
- Multi-function commander control
- Satellite navigation
- Advanced keyless push-button engine start
- Airbags SRS: front (driver and passenger) and side
- Emergency Stop Signal (ESS)
- Hill Launch Assist (HLA)
- Limited Slip Differential (MT only)
- Tyre Pressure Monitoring System (TPMS)

\*Available from late 2015.

### POWERTRAIN:

- 2.0 litre in-line 4 cylinder 16 valve DOHC S-VT petrol (SKYACTIV-G) engine
- Fuel consumption (combined): 6.9l/100km<sup>3</sup> (manual) or 7.1l/100km<sup>3</sup> (auto)
- Drivetrain: RWD
- Max power: 118kW @ 6,000rpm
- Max torque: 200Nm @ 4,600rpm
- Transmission: 6-speed manual (SKYACTIV-MT) or 6-speed auto



### LOOKS TO THRILL

17-inch alloy wheels (gunmetal) enhance without distracting for the ultimate sports car accessory.



### LET'S GO

Advanced keyless push button start operates when the driver is in the vehicle or within operational range.



### BE SEEN

LED daytime running lamps make you more visible to other drivers.



### WIRELESS SIMPLICITY

Enjoy hands-free phone<sup>2</sup> calls and wireless music playback with Bluetooth® connectivity.

## 2.0L ROADSTER GT



2.0L Roadster GT in Ceramic Metallic.



### 2.0L ROADSTER GT\* FEATURES ADDITIONAL TO 2.0L ROADSTER INCLUDE:

- Headlamps auto on/off function
- Power mirrors (body coloured with heating function)
- Rain-sensing wipers
- Seat trim: black or tan leather<sup>1</sup>
- Front seats with: heating function
- Rear-view mirror with auto dimming function
- Climate control air-conditioning
- Premium Bose® 203 watt amplifier with 9 speakers
- Advanced keyless entry

\*Available from late 2015.

### POWERTRAIN:

- 2.0 litre in-line 4 cylinder 16 valve DOHC S-VT petrol (SKYACTIV-G) engine
- Fuel consumption (combined): 6.9 l/100km<sup>3</sup> (manual) or 7.1l/100km<sup>3</sup> (auto)
- Drivetrain: RWD
- Max power: 118kW @ 6,000rpm
- Max torque: 200Nm @ 4,600rpm
- Transmission: 6-speed manual (SKYACTIV-MT) or 6-speed auto



### EXCITEMENT FROM THE GROUND UP

17-inch alloy wheels (bright silver) are the ultimate example of beauty in simplicity, enhancing Mazda MX-5's sleek sports aesthetic.



### CLASSIC LUXURY

The classic sport-luxe look of tan leather<sup>1</sup> seat trim gives you another reason to take the top down.



### MAKE SOME NOISE

Jointly developed with Bose® the premium audio system with 9 speakers is designed to produce stunning sound quality even with the top down.



### WHERE TO NEXT?

Relax and enjoy the drive with satellite navigation that's mapped out the journey for you.

# SPECIFICATIONS

Powertrain		1.5L I4 Petrol	2.0L I4 Petrol
Bore and stroke (mm)		74.5 x 85.8	83.5 x 91.2
Compression ratio		13.0 : 1	13.0 : 1
Drivetrain		RWD	RWD
Emissions standard		Euro stage V	Euro stage V
Engine capacity (cc)		1,496	1,998
Engine type		1.5 litre in-line 4 cylinder 16 valve DOHC S-VT petrol (SKYACTIV-G) engine	2.0 litre in-line 4 cylinder 16 valve DOHC S-VT petrol (SKYACTIV-G) engine
Fuel consumption (l/100km) <sup>2</sup> :			
Manual (combined)		6.1	6.9
Auto (combined)		6.4	7.1
Fuel system		----- Electronic direct injection -----	
Fuel tank capacity (litres)		45	45
Gear ratio - Manual/Auto:			
1st		5.087 / 3.538	5.087 / 3.538
2nd		2.991 / 2.060	2.991 / 2.060
3rd		2.035 / 1.404	2.035 / 1.404
4th		1.594 / 1.000	1.594 / 1.000
5th		1.286 / 0.713	1.286 / 0.713
6th		1.000 / 0.582	1.000 / 0.582
Reverse		4.696 / 3.168	4.696 / 3.168
Final drive		2.866 / 4.100	2.866 / 3.454
Maximum power (kW @ rpm)		96 @ 7,000	118 @ 6,000
Maximum torque (Nm @ rpm)		150 @ 4,800	200 @ 4,600
Recommended fuel		Premium unleaded (95RON or higher)	Premium unleaded (95RON or higher)
Throttle control		----- Electronic (drive-by-wire) -----	
Transmission:			
Manual		6-speed (SKYACTIV-MT)	6-speed (SKYACTIV-MT)
Auto		6-speed	6-speed

Model Availability		Roadster	Roadster GT
2-seat Convertible:			
1.5L I4 Petrol RWD / 6-speed manual		●	●
1.5L I4 Petrol RWD / 6-speed automatic		●	●
2.0L I4 Petrol RWD / 6-speed manual		●	●
2.0L I4 Petrol RWD / 6-speed automatic		●	●

Chassis		Roadster	Roadster GT
Brake diameter (mm):			
Front 1.5L I4 Petrol RWD		258	258
Front 2.0L I4 Petrol RWD		280	280
Rear 1.5L I4 Petrol RWD		255	255
Rear 2.0L I4 Petrol RWD		280	280
Brake type:			
Front		----- Ventilated disc -----	
Rear		----- Solid disc -----	
Steering type		----- Double-pinion electric power assist steering -----	
Suspension:			
Front		----- Double wishbone -----	
Rear		----- Multi-link -----	
Turning circle kerb to kerb (m)		9.4	9.4
Tyre size			
1.5L I4 Petrol RWD		195/50 R16	195/50 R16
2.0L I4 Petrol RWD		205/45 R17	205/45 R17
Tyre index			
1.5L I4 Petrol RWD		84V	84V
2.0L I4 Petrol RWD		84W	84W
Wheel size			
1.5L I4 Petrol RWD		16 X 6.5 J	16 X 6.5 J
2.0L I4 Petrol RWD		17 x 7.0 J	17 x 7.0 J
Wheel type		----- Alloy -----	

Weight and Capacities		Roadster	Roadster GT
Cargo room volume (litres)		130	130
Kerb weight (kg):			
1.5L I4 Petrol RWD / 6-speed manual		1,009	1,009
1.5L I4 Petrol RWD / 6-speed automatic		1,032	1,032
2.0L I4 Petrol RWD / 6-speed manual		1,033	1,033
2.0L I4 Petrol RWD / 6-speed automatic		1,057	1,057

Dimensions		Roadster	Roadster GT
Ground clearance unladen (mm)			
1.5L I4 Petrol RWD		140	140
2.0L I4 Petrol RWD		150	150
Overall length (mm)		3,915	3,915
Overall width (mm)		1,735	1,735
Overall height (mm)			
1.5L I4 Petrol RWD		1,225	1,225
2.0L I4 Petrol RWD		1,230	1,230
Track (mm):			
Front		1,495	1,495
Rear		1,505	1,505
Wheelbase (mm)		2,310	2,310

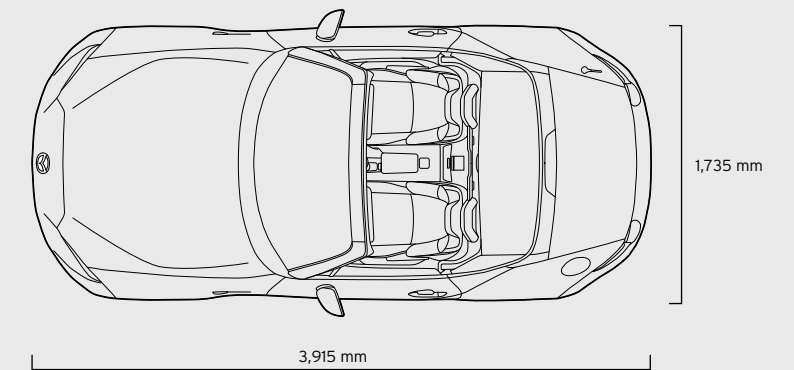
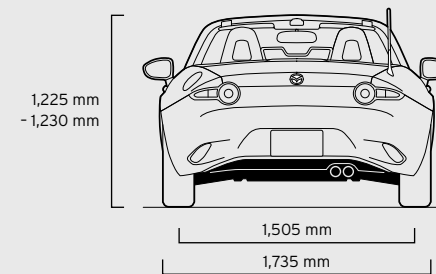
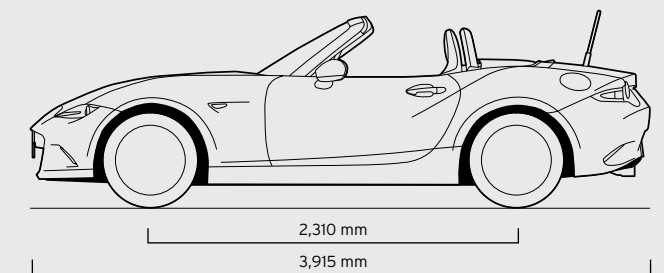
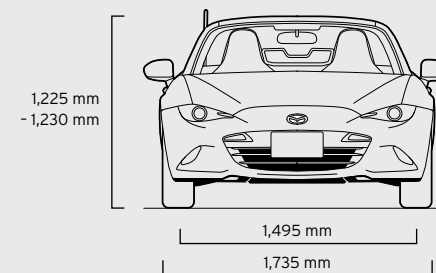

# SPECIFICATIONS

Exterior	Roadster	Roadster GT
Daytime running lamps (LED)	●*	●
Door handles (body coloured)	●	●
Exhaust extensions	●	●
Front and rear bumpers (body coloured)	●	●
Green-tinted windscreen, side and rear windows	●	●
Headlamps (LED)	●	●
Headlamps auto on/off function	-	●
Power mirrors	●	-
Power mirrors with heating function	-	●
Power windows	●	●
Soft top (cloth)	●	●
Tail-lamps (LED)	●	●
Window demister (rear)	●	●
Wipers (front) 2-speed with rain-sensing function	-	●
Wipers (front) 2-speed with variable intermittent function	●	-

Seats	Roadster	Roadster GT
Front seats with:		
Heating function	-	●
Rake and slide adjustment	●	●
Tilt adjustment (driver)	●	●
Seat trim:		
Black cloth	●	-
Black leather <sup>1</sup>	-	●
Tan leather <sup>1</sup>	-	○

Interior	Roadster	Roadster GT
Air-conditioning	●	-
Air-conditioning (climate control)	-	●
Ambient temperature display	●	●
Critical function warning lights/chimes	●	●
Cruise control	●	●
Cupholders	●	●
Instrument panel light dimmer	●	●
Interior illumination:		
Entry system with delayed fade	●	●
Map reading spot lamps	●	●
Power window switch	●	●
Leather-wrapped:		
Gearshift knob	●	●
Handbrake handle	●	●
Steering wheel	●	●
One touch (down) power windows	●	●
Puncture repair kit	●	●
Rear-view mirror with auto dimming function	-	●
Tachometer and electronic odometer/tripmeter	●	●
Tilt adjustable steering wheel	●	●
Trip computer <sup>4</sup>	●	●
Vanity mirrors	●	●

● = Standard, ●\* = Standard (2.0L I4 Petrol only), ○ = Option, - = Not available.

Infotainment	Roadster	Roadster GT
7-inch full colour touch screen display (MZD Connect)	○	●
AM/FM tuner	●	●
Auxiliary-audio input jack (3.5mm mini-stereo)	●	●
Bluetooth® hands-free phone and audio capability <sup>2</sup>	●	●
Internet radio integration (Pandora®, Stitcher™ and Aha™)	○	●
Multi-function commander control	○	●
Premium Bose® 203 watt amplifier and speakers	-	●
Radio Data System (RDS) program information	●	●
Satellite navigation	○	●
Speakers (6)	●	-
Speakers (9)	-	●
Steering wheel-mounted audio controls	●	●
USB-audio input port (iPod compatible)	●	●

Safety and Security	Roadster	Roadster GT
Advanced keyless entry	-	●
Advanced keyless push-button engine start	●	●
Airbags SRS:		
Front (driver and passenger)	●	●
Side	●	●
Anti-lock Braking System (ABS)	●	●
Dynamic Stability Control (DSC)	●	●
Electronic Brake-force Distribution (EBD)	●	●
Emergency Brake Assist (EBA)	●	●
Emergency Stop Signal (ESS)	●	●
Engine immobiliser	●	●
High mount stop lamp	●	●
Hill Launch Assist (HLA)	●	●
Intrusion-minimising brake pedal	●	●
Limited-Slip Differential (LSD)	●*	●*
Remote central locking (2 transmitters)	●	●
Seat-belt warning	●	●
Seat-belts 3-point lap-sash	●	●
Seat-belts (front) with pretensioners and load-limiters	●	●
Side impact door beams	●	●
Traction Control System (TCS)	●	●

● = Standard, ●\* = Standard (6-speed manual only), ○ = Standard (2.0L I4 Petrol) & Option (1.5L I4 Petrol), - = Not available.

# ENJOY MAZDA MX-5 WITH CONFIDENCE



# ENJOY MAZDA MX-5 COLOUR AND TRIM

## BODY COLOURS



Crystal White Pearl Mica

Ceramic Metallic

Blue Reflex Mica

Soul Red Metallic\*

Meteor Grey Mica

Jet Black Mica

## INTERIOR TRIMS



Black cloth  
(Roadster)

Black leather<sup>1</sup>  
(Roadster GT)

Tan leather<sup>1</sup>  
(Roadster GT)

### REST ASSURED - YOUR WARRANTY

The quality built into Mazda MX-5 is backed up by a 3-year, unlimited kilometre factory warranty and 6-year panel protection warranty.

### MAINTAIN THAT ZOOM-ZOOM

Your Mazda MX-5 deserves the best in care. Servicing with Mazda Service Select gives your car the advantage of factory trained Service Technicians and advanced computer diagnostic systems. As well as maintaining your Mazda in A1 condition, you'll also be protecting your vehicle's outstanding resale value.



### HELP IS AT HAND MAZDA ROADSIDE ASSISTANCE

Flat batteries, running out of fuel, flat tyres – everyone faces hiccups from time to time. When the unexpected happens, Mazda Roadside Assistance is there to keep you moving. You'll be covered 24 hours a day, 365 days a year, all around Australia. Better still, your Mazda will only be worked on by Mazda-approved technicians. Choose a Standard policy offering everything needed to get going again, or Premium with extras like accommodation, a rental car and vehicle recovery. Either can be purchased across the entire Mazda range. (Terms and conditions apply.)

\*2.0L Roadster and 2.0L Roadster GT available from late 2015. (1) Leather interior includes some Maztex material on selected high impact surfaces. (2) Please check the compatibility of your Bluetooth® device (particularly your mobile phone) with the specific Mazda vehicle you intend to purchase, as not all devices operate correctly. Visit [www.mazda.com.au/Bluetooth](http://www.mazda.com.au/Bluetooth) or consult your Mazda Dealer for further information. (3) Fuel consumption figures are based on ADR 81/02 test results. They are useful in comparing the fuel consumption of different vehicles. They may not be the fuel consumption achieved in practice. This will depend on traffic and road conditions and how the vehicle is driven. (4) Trip computer displays current and average fuel consumption, distance to empty and average vehicle speed.

All care is taken to ensure the accuracy of this brochure at the time of publication. Specifications, features and model availability may vary from State to State and may change without notice. Please refer to [mazda.com.au](http://mazda.com.au) or consult your Mazda Dealer prior to placing an order to ascertain current information on model availability, specifications, options, features and prices. Mazda Australia Pty Ltd will not be liable for any loss arising from the information in this brochure, whether in negligence or otherwise. Mazda Australia Pty Ltd ABN 78 004 690 804. 385 Ferntree Gully Road, Mt Waverley, Victoria 3149. iPod is a trademark of Apple Inc., registered in the U.S. and other countries. Due to the nature of the printing process, colours may vary from those shown in this brochure. Ask your Dealer to show you a product sample.

■ At extra cost.





mazda

zoom-zoom



Like us on the official Mazda Australia fan page for the latest pictures, videos, events, news and competitions. Ask questions, give feedback or upload your own photos. Join the conversation at [facebook.com/mazdaaus](https://facebook.com/mazdaaus)



Join the conversation on Twitter. Keep up with breaking Mazda news, videos and pictures from around the web. Tweet your questions, give feedback or post your own photos. [twitter.com/mazdaaus](https://twitter.com/mazdaaus)



Visit Mazda Australia's YouTube channel. You'll find video content with exclusive behind-the-scenes footage. [youtube.com/zoomzoom](https://youtube.com/zoomzoom)

# *MAZDA MX-5 ACCESSORIES*



mazda

*zoom-zoom*



*IMAGINATION DRIVES US*

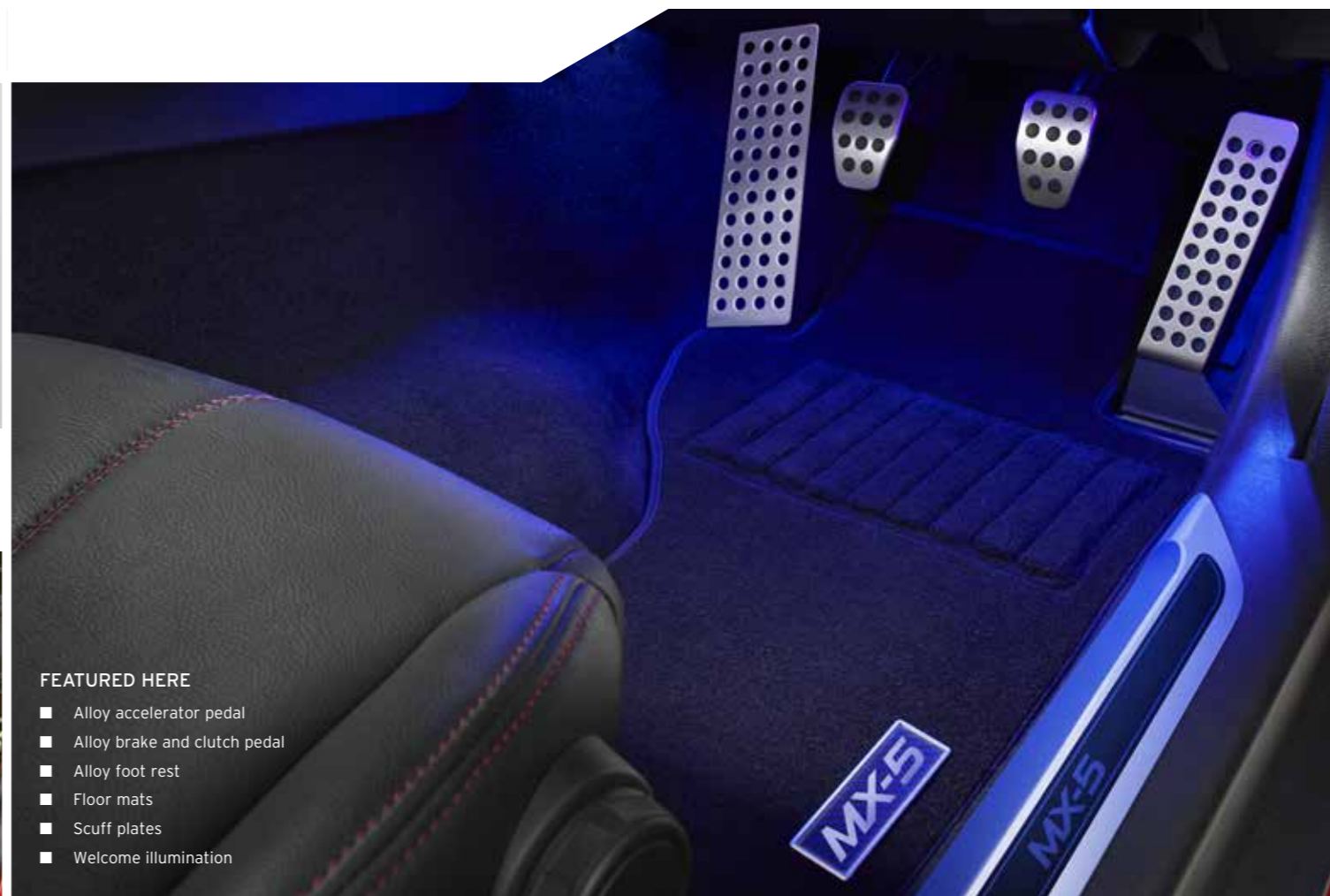

#### FRONT PARKING SENSORS

Audio alerts warn you of obstructions at the front of your car whilst parking.

#### REAR PARKING SENSORS

Park your MX-5 with ease. A warning tone helps prevent rear bumper damage by alerting you to obstacles.

#### FEATURED HERE

- Alloy accelerator pedal
- Alloy brake and clutch pedal
- Alloy foot rest
- Floor mats
- Scuff plates
- Welcome illumination



#### WIND BLOCKER

Reduce wind and noise in the cabin with this durable, seamlessly-integrated deflector.

#### STRUT TOWER BAR

Creates a solid brace between the two strut towers for the ultimate driving experience.

Welcome lighting radiates soft blue illumination from both foot wells, while select additions enhance the sense of occasion.



#### FRONT MUD GUARDS

Keeps bodywork free of dirt and road grime.

#### REAR MUD GUARDS

Stop mud and road grime collecting on the rear end of your car.

#### FLOOR MATS

Protect your carpet with these high-quality, tailor-made branded floor mats. Fastening systems enhance safety.

#### SCUFF PLATES

Guard your vehicle's doorsills from scratches and scuffs with this stylish protective plate.

**KUROI SPORTS PACK**

Give your MX-5 an even sportier edge with the Kuroi Sports Pack. Combined with the top down and the open road, these Genuine Accessories further enhance the ultimate driving experience. (Items sold individually)

**FEATURED HERE**

- Air deflector
- Front under spoiler
- Protection film
- Rear lip spoiler
- Rear under spoiler
- Side under spoiler
- 16-inch black alloy wheels



1.5L Roadster GT in Soul Red Metallic.

**MAKE YOUR MAZDA EVEN MORE REWARDING**

The Mazda MX-5 is Zoom-Zoom in its purest form, delivering an all-sensory thrill that's unique to the roadster driving experience. With the addition of Mazda Genuine Accessories, your MX-5 is even more captivating, and you protect its value. Styled to complement the existing design of the vehicle, they demonstrate exceptional quality, fit and safety, all backed by a Genuine Mazda Warranty. Mazda Genuine Accessories give you even more Zoom-Zoom.



### CARGO TRAY

A non-slip, custom-fitted tray to shield the cargo surface from liquids, dirt and scratches.



### MIRROR INTEGRATED PARKING CAMERA

Rear-view mirror displays the rear camera's image on an integrated 4.3" LCD, activated when reverse is selected. Screen brightness adjusts automatically to ambient light. (1.5L Roadster only)



### SCREEN INTEGRATED PARKING CAMERA

Visually assists with reversing by displaying rear camera image on the MZD Connect screen when reverse is selected!



### SCREEN INTEGRATED PARKING SENSORS

Adds a visual element to the audible front and rear parking sensors, with graphic guides appearing on the MZD Connect screen for added confidence!



### MAZDA HIGH SPECIFICATION ALARM

For added security and peace of mind, this alarm includes auto arm/disarm, battery back-up siren, door, hot-wire, bonnet and impact protection. Microwave sensors help protect your vehicles interior with the roof up or down.

### ALSO AVAILABLE

- Alloy brake pedal (AT only)
- Audio retractable Lightning cable
- Audio retractable Micro USB cable
- Black wheel lock set
- Chrome wheel lock set
- Mazda retractable audio cable (3.5mm male-to-male)
- 17-inch black alloy wheels

SEE THE FULL RANGE OF MAZDA GENUINE ACCESSORIES AT [MAZDA.COM.AU](http://MAZDA.COM.AU)



mazda

zoom-zoom

1. Compatible with vehicles fitted with MZD Connect screen only. All care is taken to ensure the accuracy of this brochure at the time of publication. Specifications, features and availability may vary from State to State and may change without notice. Please refer to [mazda.com.au](http://mazda.com.au) or consult your Mazda Dealer prior to placing an order to ascertain current information on availability, specifications, features and prices. Mazda Australia Pty Ltd will not be liable for any loss arising from the information in this brochure, whether in negligence or otherwise. Mazda Australia Pty Ltd ABN 78 004 690 804, 385 Ferntree Gully Road, Mount Waverley, Victoria 3149. All Mazda Genuine Accessories fitted at the point of sale of a new Mazda passenger vehicle are covered under the Mazda 3-year/unlimited kilometre warranty. Mazda Genuine Accessories fitted after the sale of a new Mazda vehicle are covered by the Mazda 2-year or 40,000 kilometre warranty (whichever should occur first). Published July 2015. MAZ11521 126.007