



zoom-zoom zoom-zoom zoom-zoom zoom-zoom zoom-zoom



MX-5



Mazda 6



Mazda 3



BT-50



Mazda 2



CX-9



CX-5



Like us on the official Mazda Australia fan page for the latest pictures, videos, events, news and competitions. Ask questions, give feedback or upload your own photos. **Join the conversation at [facebook.com/mazdaaus](https://www.facebook.com/mazdaaus)**



Join the conversation on Twitter. Keep up with breaking Mazda news, videos and pictures from around the web. Tweet your questions, give feedback or post your own photos. **twitter.com/mazdaaus**



Visit Mazda Australia's YouTube channel. You'll find video content with exclusive behind-the-scenes footage. **[youtube.com/zoomzoom](https://www.youtube.com/zoomzoom)**

Published March 2014. MAZ1114.126.002

For further information visit mazda.com.au or Freecall 1800 034 411

Mazda 2

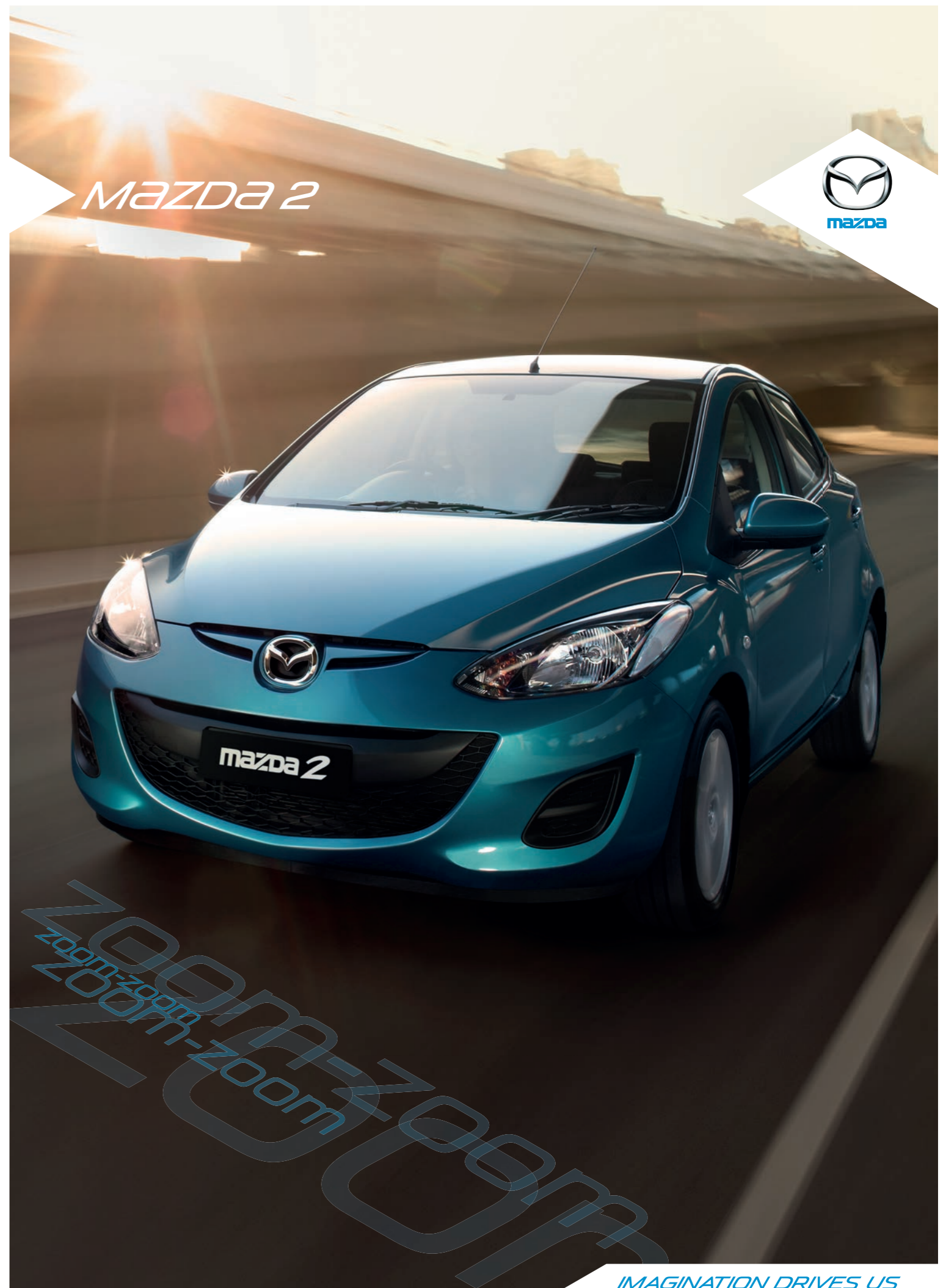

IMAGINATION DRIVES US

Mazda2 is compact

yet puts no limits on you

It's your key to freedom and adventure

because these are built into its personality

A more enjoyable drive

would be hard to imagine





*ALL THE BEST THINGS
IN ONE PLACE*

When lots of things you like come together, it makes for something special. It could be getting all your friends around one table. Or checking out a city that's bursting with life. Mazda2 also puts a lot that's great in one place. It's compact, but packs in everything you need to live large. It's light and streamlined to be more affordable to run, yet solid enough to keep you grounded.

The sporty design moves through town with agile ease, and responsive steering handles both city and country with confidence. And it's little enough to squeeze into the tightest spots. At its core is a 1.5 litre engine that's light on fuel, and still gives you all the go you need. In fact, its fuel economy is up there with the best.

While great style always seems effortless, a lot of work goes into looking good. So Mazda2 is crafted down to the tiniest detail - classy co-ordination and stylish highlights give its well-toned body plenty of street presence. For a car this size, it packs in a whole lotta Zoom-Zoom.



EVERYTHING CLICKS INSIDE

It's when you get to know the little things about Mazda2 that everything just clicks. Every detail feels like it's designed just for you, from clever ideas including a rack for things like maps and glossies, to the front console putting everything you need close by. Or perfectly placed cup-holders that keep your favourite refreshment handy. You know, the important stuff.

Power windows and mirrors make things easier still. And a big soundtrack is also important. That's why Mazda2 packs a CD player with four punchy speakers, USB and an auxiliary jack so you can hook up your MP3 player and go. You get cruise control across the range while Maxx Sport adds climate control air-conditioning, a leather wrapped steering wheel and a trip computer. And with a stylishly uncluttered instrument panel, everything feels roomier.

But the easy-to-get-along-with feeling doesn't stop there. Add enough carrying space for the biggest weekend away or the most serious shopping day, and you begin to see the big places that Mazda2 can take you.



Open for business, and for fun. A push button-operated hatch opens up a roomy luggage area.



Hit play. All models put audio controls right on the steering wheel.



Get in gear. Take your pick of a slick shifting 5-speed manual, or keep it simple with smooth 4-speed auto.



Switched on. Power window and mirror switches are a wrist flex away.

STAY OUT OF TROUBLE

The best way to be safe is to avoid trouble altogether - and that's where it's great to have Mazda2's agile, secure handling on your side. But it's also looking out for you in many other ways.

At its core is the Mazda Advanced Impact Distribution and Absorption System (MAIDAS), which absorbs and redirects impact energy away from the rigid occupant cell. Every model comes with ABS and Dynamic Stability Control (DSC), to help keep you headed to where you want to go, and stop you from going anywhere you don't. It's also good to know you're looked after by front, side and curtain airbags across the range. Front seatbelts are equipped with reminders, plus pretensioners and load-limiters.

Powerful brakes give you that extra confidence. They're backed up by ABS to help avoid skids under braking, plus Electronic Brake-force Distribution (EBD) that optimises braking according to the load on board. What's more, Emergency Brake Assist (EBA) recognises emergency braking and gives you added stopping power right when you need it.

And there's even more reason to feel secure. Mazda2 is equipped with an engine immobiliser and remote central locking to keep out unwelcome guests.



In control. Fully independent suspension delivers responsive, secure handling. Electric steering system enhances control.

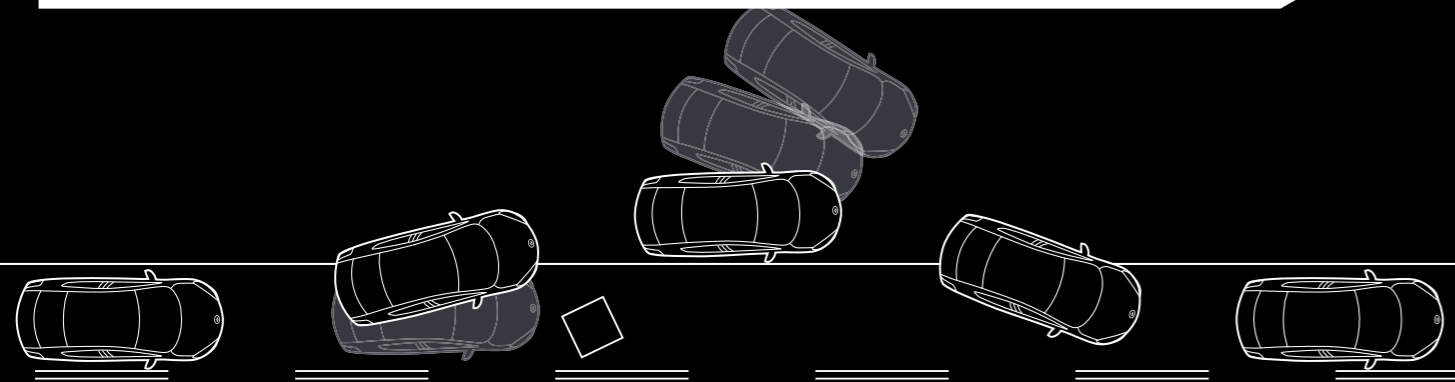

Prepared for the unexpected. So what if you're faced with an unanticipated hazard and have to react suddenly? DSC acts instantly, braking the inner rear wheel to counter understeer (or outer front wheel to counter oversteer). At the same time, the TCS reduces torque to the driven wheels to minimise slip. As a result, control is maintained and the vehicle can be safely steered around the obstacle.



Well handled. Every Mazda2 is fitted with high performance tyres for superior handling and safety.



Secure stopping.
Stopping distance with EBA, ABS and EBD.

Stopping distance with no assistance.

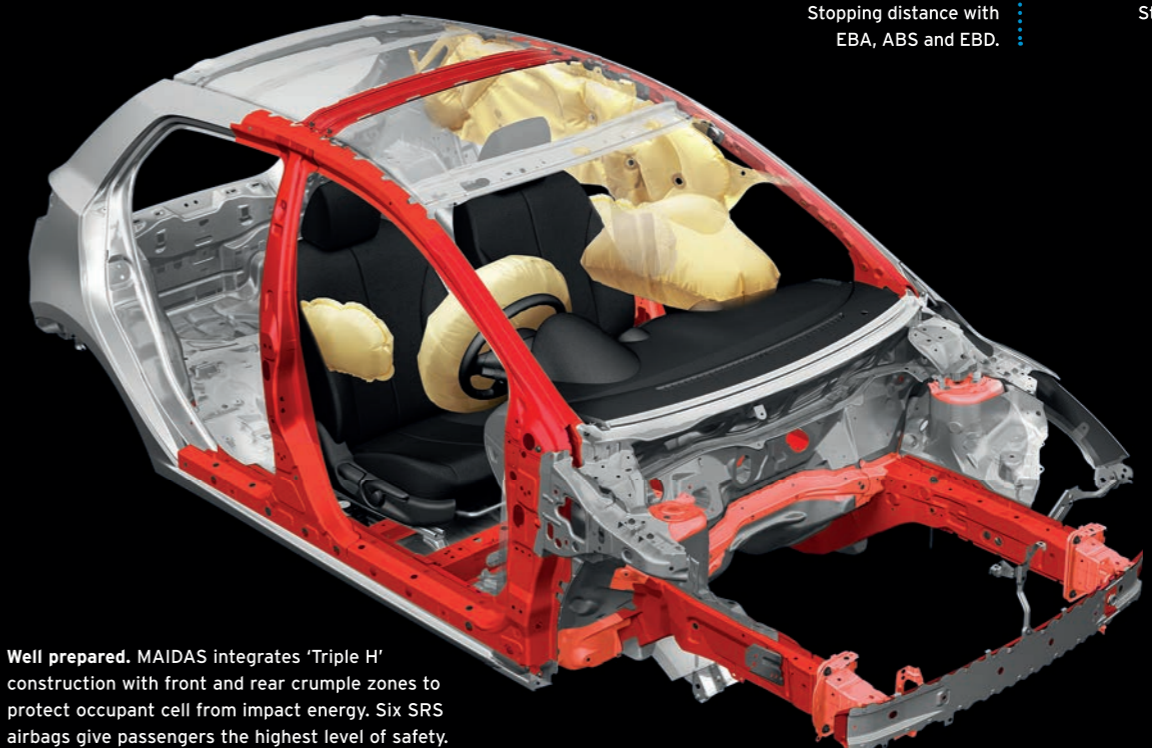

Well prepared. MAIDAS integrates 'Triple H' construction with front and rear crumple zones to protect occupant cell from impact energy. Six SRS airbags give passengers the highest level of safety.

NEO SPORT

Chic looks, smart features, and great economy too. Add Zoom-Zoom enjoyment and Neo Sport gives you all the best things in a small package.

- 1.5 litre in-line 4 cylinder DOHC S-VT
- Max. power: 76 kW @ 6,000 rpm
- Max. torque: 135 Nm @ 4,000 rpm
- 42 litre fuel tank capacity
- 5-speed manual or 4-speed automatic
- 15 inch alloy wheels
- Headlamps (Halogen)
- Power mirrors and windows
- Air-conditioning
- Cruise control
- Seat trim: cloth
- Seats (front) with: height adjustment (driver)
- Seats (rear) with: 60/40 split fold backrest
- Tilt adjustable steering wheel
- Vanity mirrors (front)
- Wipers (front) 2-speed with intermittent function
- Wiper (rear) with intermittent function
- AM/FM tuner with CD player, single disc (MP3 compatible) and 4 speakers
- Auxiliary input (3.5 mm MP3 player compatible)
- Steering wheel-mounted audio controls
- USB input (iPod® compatible)
- Airbags SRS: front (driver and passenger), side (front) and curtain (front and rear)
- Anti-lock Braking System (ABS)
- Dynamic Stability Control (DSC)
- Electronic Brake-force Distribution (EBD)
- Emergency Brake Assist (EBA)
- Remote central locking
- Traction Control System (TCS)
- 'Triple H' safety construction with front and rear crumple zones



Hatch



NEO SPORT IN BLUE REFLEX MICA

MAXX SPORT

With Maxx Sport you'll really make your mark. Luxury touches on the inside and sporty accents outside help you stand out.

Maxx Sport features additional to Neo Sport include:

- Exhaust extension (chrome)
- Fog-lamps (front)
- Rear roof spoiler
- Air-conditioning (climate control)
- Ambient temperature display
- Leather-wrapped gear shift knob (manual only)
- Leather-wrapped steering wheel
- Trip computer



Hatch



MAXX SPORT IN TRUE RED

SPECIFICATIONS

Neo Sport

Maxx Sport

Powertrain		
Engine type	1.5 litre in-line 4 cylinder 16 valve DOHC S-VT	
Engine capacity	1,498 cc	
Bore and stroke	78.0 mm x 78.4 mm	
Compression ratio	10.0 : 1	
Maximum power	76 kW @ 6,000 rpm	
Maximum torque	135 Nm @ 4,000 rpm	
Throttle control	Electronic (drive-by-wire)	
Fuel system	Electronic fuel injection	
Fuel tank capacity	42 litres	
Recommended fuel	Unleaded (91RON or higher) or E10	
Fuel consumption ¹	man (combined)	6.4 litres per 100 km
	auto (combined)	6.8 litres per 100 km
Emission standard	Euro stage IV	
Manual transmission	5-speed	
Automatic transmission	4-speed	
Gear ratio	1st - man / auto	3.416 / 2.816
	2nd	1.842 / 1.553
	3rd	1.290 / 1.000
	4th	0.972 / 0.695
	5th	0.775 / -
	reverse	3.214 / 2.279
	final drive	4.105 / 4.147

Chassis		
Brake type	front	Ventilated disc
	rear	Drum
Steering type	Electric power assist steering	
Steering wheel turns lock to lock	2.7	
Suspension	front	MacPherson strut
	rear	Torsion beam
Turning circle	kerb to kerb	9.8 m
Tyre size	185/55R15	
Tyre index	82V	
Wheel size	15 x 6.0 J	
Wheel type	Alloy	
Wheel type (spare)	Temporary	

Weights and capacities		
Cargo room	volume (VDA)	250 litres
	volume (VDA) ²	469 litres
Kerb weight man	man	1,010 kg
	auto	1,032 kg
Towing capacity ³	braked	700 kg
	unbraked	500 kg

Dimensions		
Ground clearance	laden	119 mm
Overall height		1,475 mm
Overall length		3,900 mm
Overall width		1,695 mm
Track	front	1,475 mm
	rear	1,465 mm
Wheelbase		2,490 mm

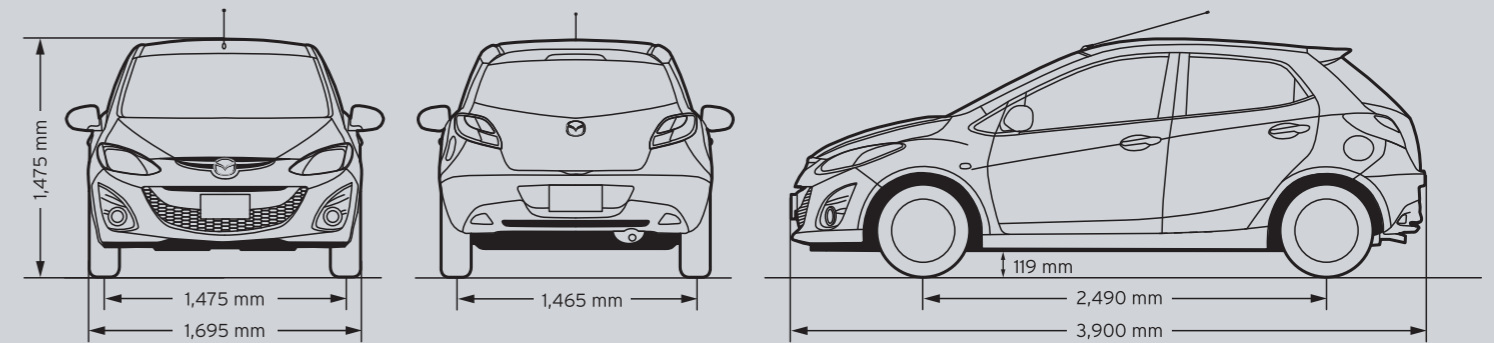

NEO SPORT IN AQUATIC BLUE MICA

SPECIFICATIONS

Neo Sport

Maxx Sport

Exterior

Door handles (body coloured)	●	●
Exhaust extension (chrome)	–	●
Fog-lamps (front)	–	●
Front and rear bumpers (body coloured)	●	●
Green-tinted windscreen, side and rear windows	●	●
Headlamps (Halogen)	●	●
Metallic/Mica paint	○	○
Mudflaps (front and rear)	●	●
Power mirrors and windows	●	●
Rear spoiler	–	●

Interior

12 volt power outlet	●	●
Air-conditioning	●	–
Air-conditioning (climate control)	–	●
Ambient temperature display	–	●
Cruise control	●	●
Cupholders	●	●
Digital clock	●	●
Door ajar warning light	●	●
Door map pockets (front)	●	●
Driver's left footrest	●	●
Glove box with magazine rack	●	●
Illuminated entry system with delayed fade	●	●
Instrument panel light dimmer	●	●
Interior illumination:		
cargo room lamp	●	●
dome lamp	●	●
Interior release for fuel filler door	●	●
Leather-wrapped:		
manual gear shift knob	–	●
steering wheel	–	●
Lights-left-on audible warning	●	●
Low fuel warning light	●	●
Passenger assist grip (front)	●	●
Rear console tray	●	●
Seat trim:		
cloth	●	●
Seats (front) with:		
adjustable head restraints	●	●
height adjustment (driver)	●	●
rake and slide adjustment	●	●
Seats (rear) with:		
60/40 split-fold backrest	●	●
adjustable head restraints	●	●
Tachometer and electronic odometer/tripmeter	●	●
Trip computer (current and average fuel consumption, distance to empty and average vehicle speed)	–	●
Vanity mirrors (front)	●	●
Ventilation pollen filter	●	●
Window demister (rear)	●	●
Wipers (front) 2-speed with intermittent function	●	●
Wiper (rear) with intermittent function	●	●

Neo Sport

Maxx Sport

Audio

AM/FM tuner	●	●
Auxiliary input (3.5 mm MP3 player compatible)	●	●
CD player, single disc (MP3 compatible)	●	●
Speakers (4)	●	●
Steering wheel-mounted audio controls	●	●
USB input (iPod® compatible)	●	●

Safety

Airbags SRS front (driver and passenger)	●	●
Airbags SRS side (front)	●	●
Airbags SRS curtain (front and rear)	●	●
Anti-lock Braking System (ABS)	●	●
Child restraint anchor points and childproof rear door locks	●	●
Collapsible steering column	●	●
Dynamic Stability Control (DSC) - switchable on/off	●	●
Electronic Brake-force Distribution (EBD)	●	●
Emergency Brake Assist (EBA)	●	●
Engine immobiliser	●	●
High mount stop lamp	●	●
Intrusion-minimising brake pedal	●	●
Left-hand-side convex (wide angle) exterior mirror	●	●
One touch (up and down) power window (driver)	●	●
Remote central locking (one transmitter with retractable key)	●	●
Seat-belt warning audible and visual (front)	●	●
Seat-belts 3-point lap-sash (all seats)	●	●
Seat-belts (front) with pretensioners, load-limiters and height adjustable shoulder anchorages	●	●
Side impact door beams	●	●
Traction Control System (TCS)	●	●
'Triple H' safety construction with front and rear crumple zones	●	●
Whiplash-minimising front seats	●	●



GRAM STRATEGY

LESS WEIGHT MEANS MORE ZOOM-ZOOM

If a car is lighter, it's more responsive and alive to drive. More fun, in other words. Not only that, but it uses less fuel and creates lower emissions. With Mazda2, we challenged ourselves to cut weight by 100kg - a huge amount for a small car. This goal was achieved by looking beyond major components such as the body, chassis and engine. We examined every last bolt and nut looking to save weight, while maintaining strength and safety. This 'gram strategy' came from the realisation that if every part could be made just a gram lighter, it would add up to several kilos. You'll appreciate this exacting approach from behind the wheel of Mazda2. Because at Mazda, Zoom-Zoom is something we're always looking to add more of.

Rest assured - your warranty

The quality built into Mazda2 is backed up by a 3-year, unlimited kilometre factory warranty and 6-year panel protection warranty. For further information on Mazda warranties, go to mazda.com.au



Help is at hand - Mazda Roadside Assistance

Flat batteries, running out of fuel and flat tyres - everyone faces hiccups from time to time. When the unexpected happens, Mazda Roadside Assistance is there to keep you moving. You'll be covered 24 hours a day, 365 days a year, all around Australia. Better still, your Mazda will only be worked on by Mazda-approved technicians. Choose a Standard policy offering everything needed to get going again, or the Premium policy with extra benefits like accommodation, a rental car and vehicle recovery. Either policy can be purchased across the entire Mazda range. (Terms and conditions apply.)

Maintain that Zoom-Zoom

Your Mazda2 deserves the best in care. Servicing through the Mazda Maintenance Program gives your car the advantage of factory trained Service Technicians and advanced computer diagnostic systems. As well as maintaining your Mazda in top condition, you'll also be protecting its outstanding resale value.

Accessories add enjoyment

Mazda2 packs a whole lot of enjoyment into a small car. And with Mazda Genuine Accessories, Mazda2 ownership is even more fun. They let you personalise your car, and protect its value. They also offer great design, quality and safety, plus the backing of a Mazda Genuine Warranty. Mazda Genuine Accessories give you even more Zoom-Zoom.

COLOURS

Exterior

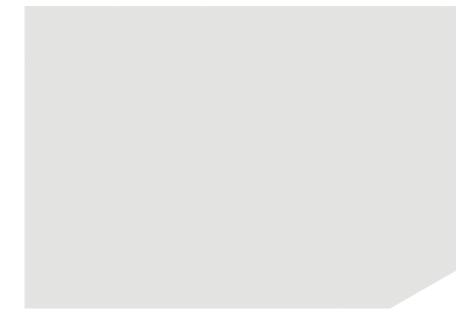

Crystal White Pearl
Mica



Aluminium
Metallic



Blue Reflex
Mica



Aquatic Blue
Mica



True Red



Meteor Grey
Mica



Deep Crystal Blue
Mica



Jet Black
Mica

Interior

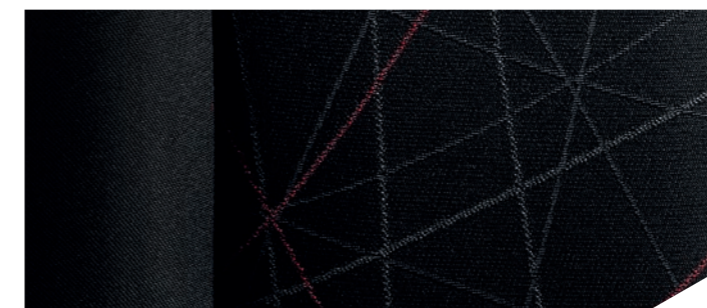

Neo Sport

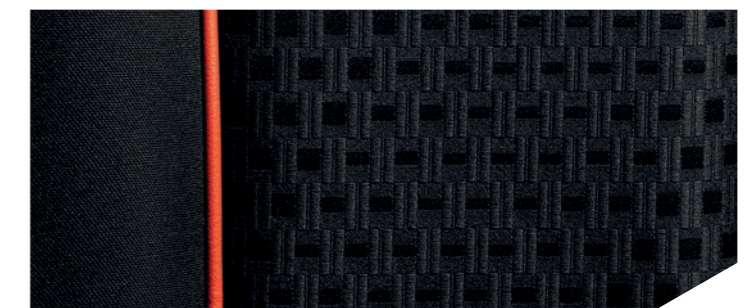

Maxx Sport