

The E-Class.

Saloon and Estate.



Mercedes-Benz

This Brochure is prepared by Daimler AG and it predominantly reflects the capabilities and performance of vehicles sold in Europe.

Some characteristics, capabilities, performance features and optional extras (e.g. towing systems) may not be available or may not apply in Australia under Australian conditions. The information in this Brochure is therefore indicative, illustrative and provided only for guidance and should not be relied on. To obtain current and accurate information on a vehicle and any options applicable to Australia, contact your local authorised Mercedes-Benz dealer.

The E-Class. In top form.

The E-Class makes many things easier for you. Apart from the decision about which model best suits your requirements. Because both the E-Class Saloon and the E-Class Estate cut a more dynamic figure than ever before, with considerably sharpened contours. Expressive highlights meet the elegant genes which have always characterised an E-Class – high culture, above all for the eyes.

The perspective from behind the steering wheel also offers a fine outlook. Where numerous safety and assistance systems have one thing above all in mind: ensuring that you are as comfortable as possible in every traffic situation. So whether you are simply enjoying the route for the sake of driving or travelling on the road you have to take: the E-Class makes it easy for you. With the estate the sky is virtually your limit when it comes to loading up, thanks to the above-average load capacity. Whichever way you look at it – with maximum elegance or a sumptuous amount of space: the E-Class more than meets your demands.

Guide to the vehicles shown here:

2 | Mercedes-Benz E 500 Saloon **iridium silver metallic**

AVANTGARDE line with AMG Sports package, 5-twin-spoke AMG light-alloy wheels, crystal grey nappa leather upholstery, dark textured-grain aluminium trim

12 | Mercedes-Benz E 400 Estate **obsidian black metallic**

ELEGANCE line, multi-spoke light-alloy wheels, porcelain nappa leather upholstery, brown open-pore ash wood trim

22 | Mercedes-Benz E 63 AMG S-Model 4MATIC **diamond white metallic BRIGHT**

10-spoke AMG light-alloy wheels, black nappa leather upholstery, high-gloss black ash wood trim

The equipment options at a glance:

34 | Drive system and chassis

46 | Safety

52 | Comfort

62 | AMG

72 | Equipment and appointments

100 | Services

102 | Facts and colours

The illustrations may include accessories and optional extras which do not form part of the standard specification.

For the record:

Executive post filled.





Where does the pursuit of happiness end?

On the road in this case.

From the initial visual impression to the tingling in the fingertips, and from the first to the last moment of an encounter, it's hard not to be impressed by the E-Class AVANTGARDE. Its appeal is further enhanced by the optional AMG Sports package, with the focus firmly on dynamic design and an even keener awareness of style. Once you've experienced its power and agility on the road, you'll know why those initial emotions were so intense. → Page 80–83, 88–89





Presentation:

Impresses from the first second.

A human being can read the feelings and intentions of the character before them by looking at their face. This is where an entire book on strength, determination, assertiveness and vigour is presented. Two piercing eyes, behind which there is both a powerplant that teases emotions from the driver and also many systems which safely shape the route to the destination through attentiveness. → Page 46-49



Block your diary:

Agenda for the whole week:
Sportiness and refinement.



Harmony is a recurring theme throughout the E-Class. Be it the axle load distribution or the design. And the range of available engines covering all a driver could wish for – sporty refinement for pleasure or long-distance comfort for business. But it's best to experience it for yourself. → Page 36–41





Memo:

The ideal place to forget about time.

When was the last time you felt at home when out on the road? An attractive aluminium trim and a centre console with an analogue clock bring refinement to the cockpit and create a space that is far away from the ordinary. Not least because we leave the other equipment and appointments for your E-Class to your good taste and sound judgement. One thing's for sure: there's no shortage of choice.





Like:

Always shows its best side.
Whichever way you look at it.

The E-Class redefines the meaning of size. Its stature signals powerful forwards thrust. The feature lines in the side sections signify dynamism and strength of purpose. Powerful and efficient engines then deliver on this promise. For a grand entrance calls for a spectacular start.

Safety check:

All systems active.

Safety is always also a question of trust. The answer comes courtesy of the Mercedes-Benz Intelligent Drive technologies, which offer you all the assistance you need when you need it most. You see better and are better seen. You brake harder when it really matters. For everyone knows that a few seconds of foresight can sometimes be worth years. → Page 34, 46–49



Time to unwind:

Look for detours more often than short cuts.





In an ideal scenario, driving a car means less stress – not more. In the E-Class you are assisted by a multitude of helpful systems. For example, you can see current speed limits and overtaking bans on the instrument cluster, while your car can detect signs of drowsiness and advise you to take a break. As you're in such good hands, you might sometimes voluntarily take the longer route. Purely for relaxation purposes, of course. → Page 46, 54–55

Reply to all:

There's enough space for everyone.

Life always throws up new challenges. It's good to know that there's a car prepared for them. The E-Class Estate gives you what you would expect: freedom rather than restrictions, enjoyment rather than obligations and solutions rather than problems. There's even an optional folding bench seat in the load compartment. So you can do what you want. And lots more besides.
→ Page 58–61







Reminder:

The best lights come in threes.

The E-Class adapts to your requirements at the touch of a button. In the case of the ELEGANCE and AVANTGARDE design and equipment lines, for instance, you can choose from three different ambient lighting colours, depending on your mood. This provides a particularly stylish showcase for the expressively grained wood elements in ash plus numerous seat appointments. Good taste is your trusty passenger here. → Page 76–83





Note:

There's no trend that can catch up with real dynamism.

Nowadays, anyone who sees themselves at the top has to have something special to offer. Like the E 63 AMG S-Model 4MATIC, for example. Its unique acceleration and impressive handling are the result of decades of developments at the highest level. You can now distribute the immense power planted on the road equally between all four wheels: this vehicle is the first performance saloon from Mercedes-AMG that underlines the ambition to lead with the AMG-specific 4MATIC all-wheel drive system.
→ Page 64–67

This evening:

Circuit training – for the muscle
beneath the bonnet.

Brace yourself for an encounter of an impressive nature. Because it's not only the engines of the AMG models that ensure lasting fascination. You will find the exclusive equipment and appointments just as difficult to resist as the light-alloy wheels. An ideal opportunity to increase your lead – even whilst at a standstill. → Page 62–71







On the wish list:

585 horses with red brake callipers.

To make the best use of the power produced by the E 63 AMG S-Model 4MATIC, you have to be able to control it, which is why the brakes are as effective as the powerful drive system they counteract. Red-painted callipers signal that there is an immense amount of horsepower to be kept in check here. And demonstrate in action that at Mercedes-AMG everything is designed with a view to performance. Including the brakes, of course.





Top:

Pole position for every seat.

And so that no misunderstandings arise inside the AMG model either, great care was taken to adapt every last detail to the sporty character. The special AMG interior with the E-SELECT lever or AMG DRIVE UNIT is designed to make you feel like a top athlete, too. Whether you're sprinting or going long distance.

It's not just Oscar who helps keep you safe. Uwe, Gabi and Martin also do their bit.

The outside temperature display in the E-Class shows minus 18 °C. The windows are iced up. But it's a pleasant 21 °C inside. When the driver's door opens, Dr Oscar eases out of his seat, his joints grating a little. "All the measurements are done," says a colleague. But Dr Oscar doesn't join in with the discussion because he doesn't actually have a PhD. In fact, he's never even studied. He's more the object of studies. With his help, the developers are able to measure the perception of hot and cold from temperatures in excess of 70 °C down to minus 18 °C so that important safety questions can be answered. After all, a person can only control a vehicle reliably if they are in a fit state to do so. From head to toe. Our experts call this 'driver-fitness safety'. And when many details come together perfectly, it's all the higher. A pleasant interior temperature, an ergonomic seat position, intuitive controls and intelligent assistance systems are just a few examples.

Important indicators here include body temperature and heart rate. That's why, in addition to using Dr Oscar, we work with real people with real senses. People like you. The more relaxed our testers are, the more reliable their reactions. Even though palpitations are a sign of excitement, the driver's heart beats for relaxation in the E-Class.

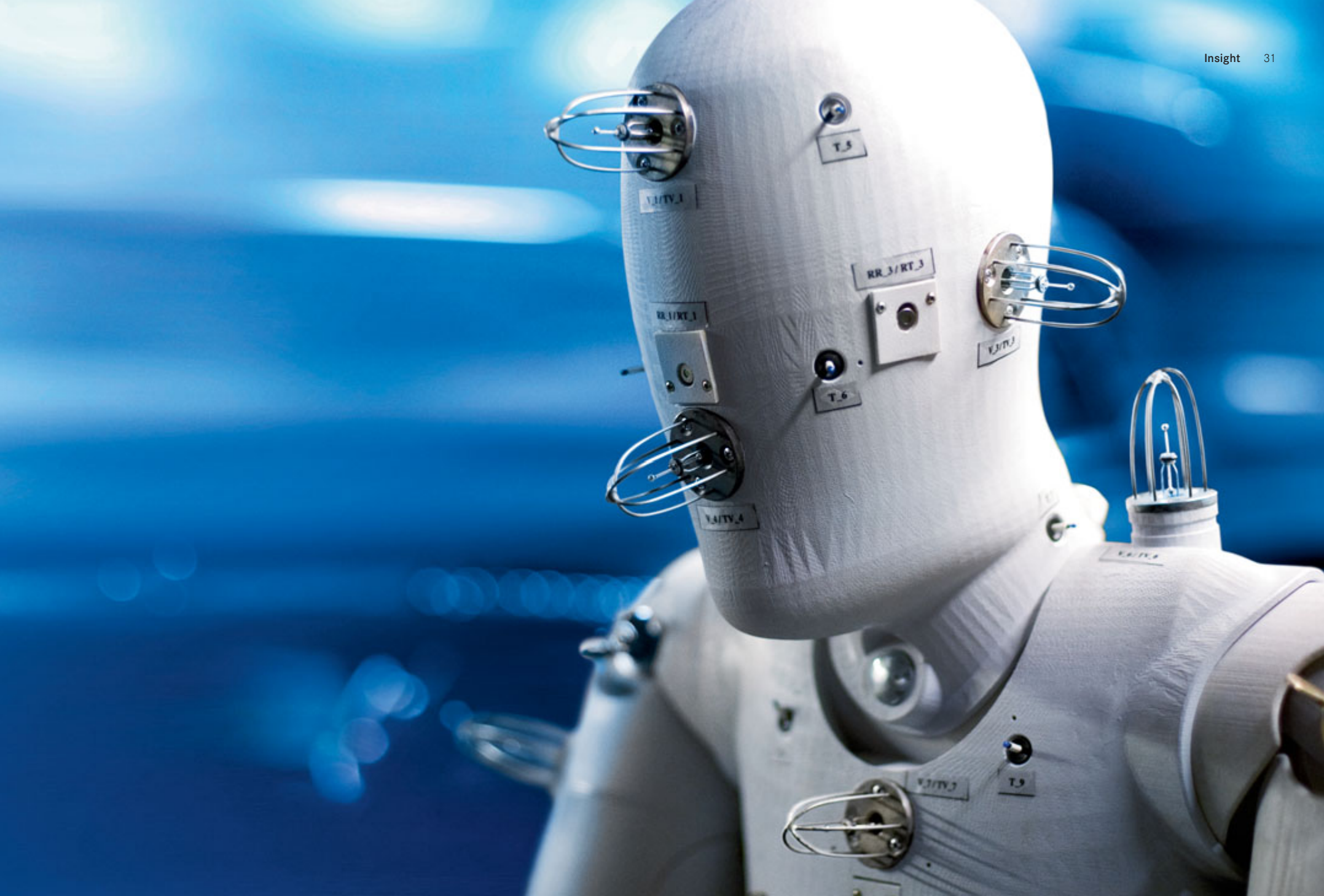

The E-Class in detail.

Drive system and chassis.

- 34 | Mercedes-Benz Intelligent Drive and Mercedes-Benz Connect
- 35 | BlueEFFICIENCY
- 36 | Diesel engines
- 38 | Petrol engines
- 40 | Alternative drive systems
- 42 | Transmissions
- 44 | Chassis & suspension

Safety.

- 46 | Integral safety concept
- 50 | E-Guard

Comfort.

- 52 | Multimedia systems
- 54 | Assistance systems
- 56 | Climate control
- 57 | Seats
- 58 | Load compartment management
- 60 | Space

AMG.

- 62 | E 63 AMG
- 64 | E 63 AMG S-Model 4MATIC
- 66 | E 63 AMG technical details
- 68 | AMG Performance Studio
- 70 | E 63 AMG packages

Equipment and appointments.

- 72 | Standard equipment/equipment lines
- 84 | Equipment packages
- 92 | Standard equipment (selection)
- 94 | Optional extras (selection)
- 96 | Wheels
- 98 | Genuine accessories

Services.

- 100 | Services

Facts and colours.

- 102 | Technical data
- 108 | Dimensions
- 108 | Paintwork

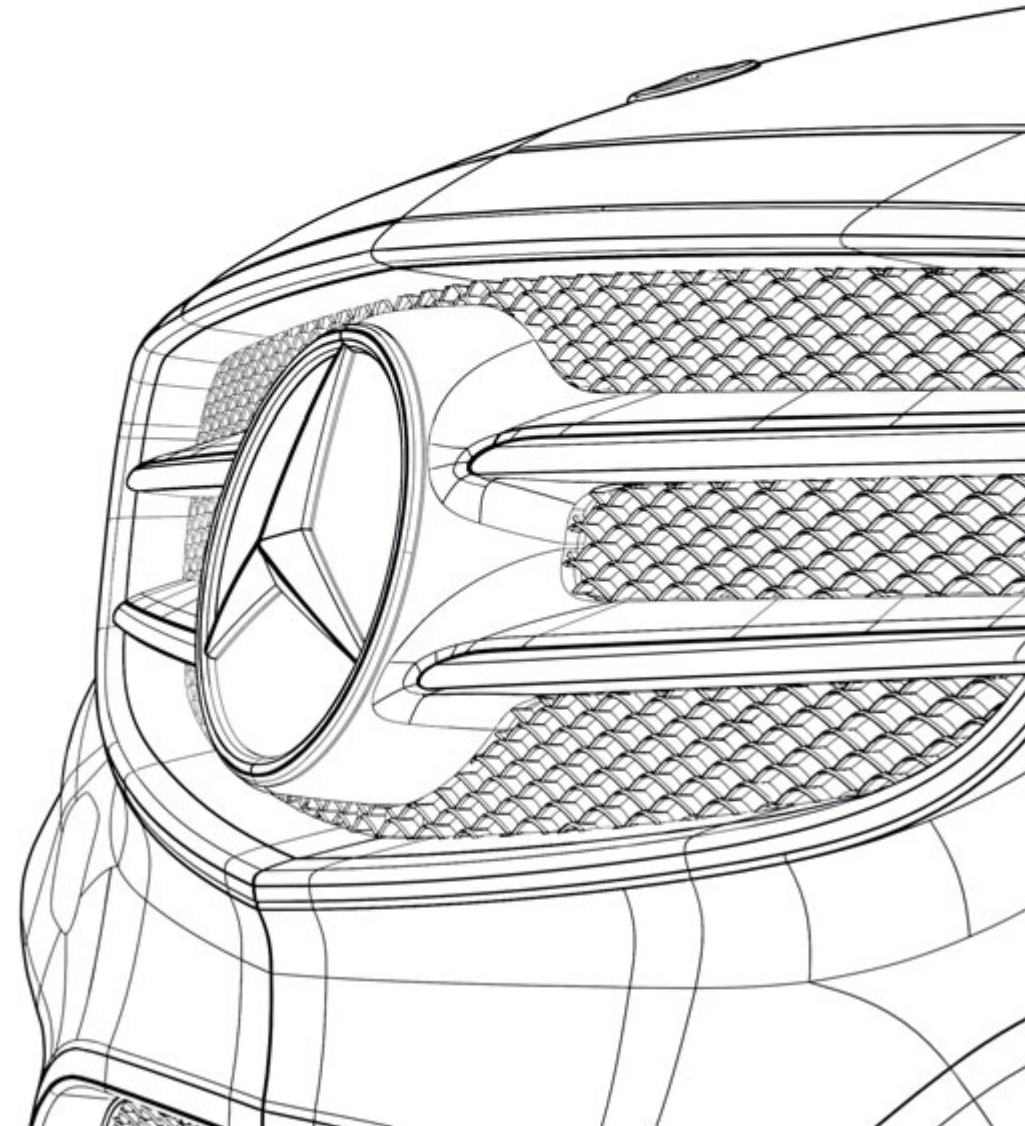

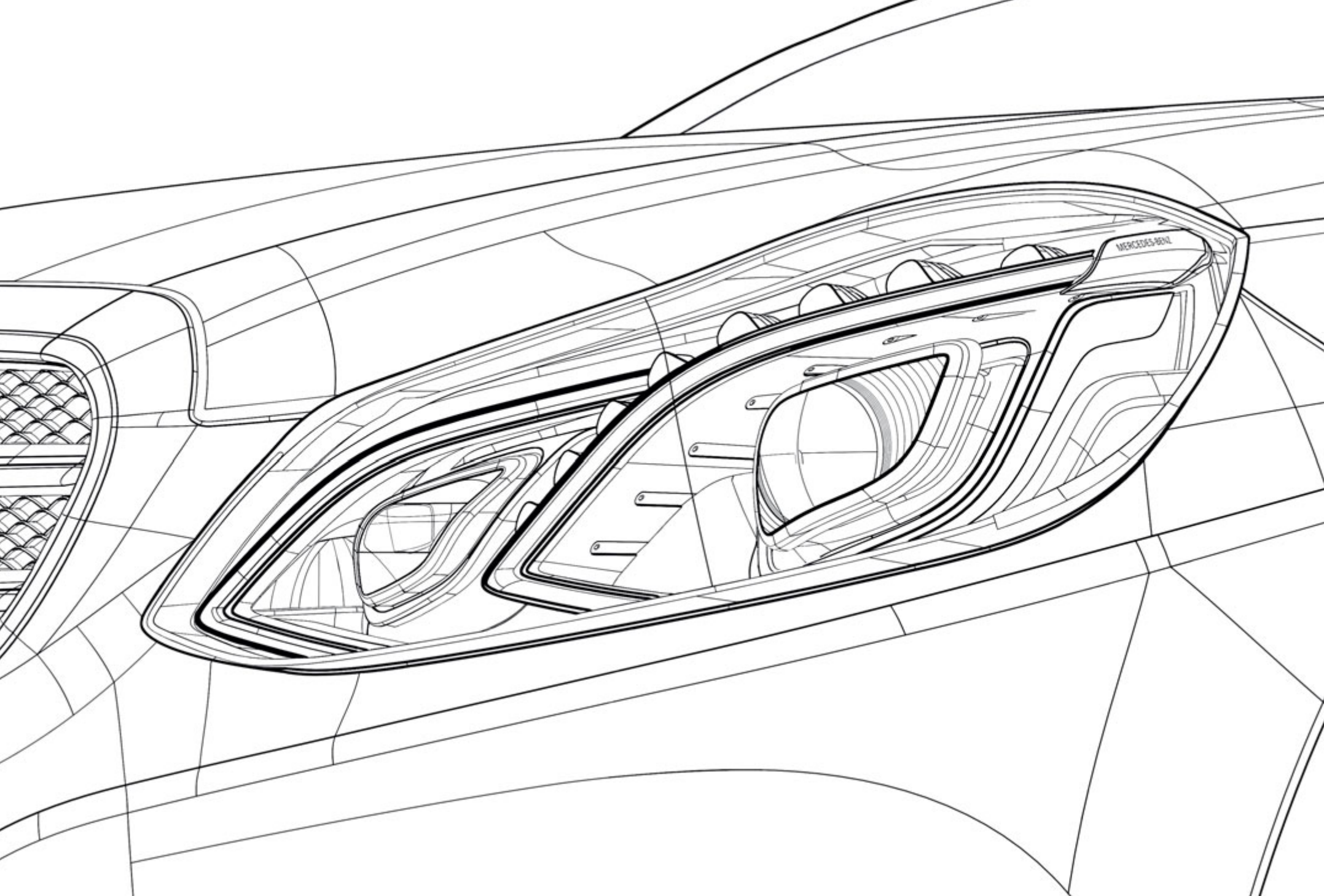

Connected with all senses.

With Mercedes-Benz Intelligent Drive and Mercedes-Benz Connect we have taught vehicles to think – and are thus a decisive step closer to the vision of accident-free, autonomous driving.

Our engineers focus on the future every day, their aim being to implement innovative technology. This aspiration has resulted in developments that have had a lasting impact on automotive engineering. In other words, we are working to make sure that a Mercedes-Benz will always be ahead of its time.

Innovative technologies such as the PRE-SAFE® anticipatory occupant protection system and DISTRONIC PLUS proximity control first made it onto the road in a Mercedes-Benz, setting new standards in vehicle safety. It was the first time active and passive systems had been combined – for even better protection and ride comfort. We have developed one groundbreaking solution after another to get closer to realising our aim of accident-free and autonomous driving. And now we have taken one step further.

Mercedes-Benz Intelligent Drive. This is the intelligent linking of the sensor system in the driver assistance and safety systems. It meets high vehicle and road safety standards to an unprecedented degree.

One of the ways in which this is achieved is through the optimum interplay of diverse functions in the Driving Assistance package Plus. For instance, the BAS PLUS system with Cross-Traffic Assist helps prevent rear-end collisions plus accidents at road junctions and supports the driver in a critical braking situation through additional brake pressure. The PRE-SAFE® Brake with pedestrian recognition warns the driver if the danger of a collision with a vehicle or pedestrian is detected. If there is no reaction it can reduce the speed autonomously – right through to a full brake application.

The driver assistance system DISTRONIC PLUS with Steering Assist and Stop&Go Pilot represents a significant step towards autonomous driving. The Steering Assist relieves the burden on the driver in their lateral guidance of the vehicle and helps them to stay in their lane. In order to do this the system uses a stereo camera to orientate itself by the road markings and also by the vehicle in front at lower speeds. The system brakes, where necessary, and accelerates again, where possible, to the desired speed selected. This means an increase in ride comfort, in particular on long routes.

Mercedes-Benz Connect. This is the intelligent fusion of the car and the internet. Mercedes-Benz Connect turns your car into a reliable digital companion with lots of trendsetting comfort, safety and information services. The following equipment items and systems are just some of those under the umbrella of Mercedes-Benz Connect: COMAND Online, Live Traffic Information, the Mercedes-Benz emergency call system plus numerous individual Mercedes-Benz Apps. Your vehicle can become acquainted with your driving habits and adapt in accordance with your preferences. It will support you with concrete recommendations for action and will be able to interact with your social networks. The vision of seamlessly networked mobility is thus becoming reality. Mercedes-Benz Connect will sustainably change future motoring and make it even more comfortable, even more efficient and even safer.

Today a Mercedes-Benz is a car which can register the road and traffic conditions at any time, warn the driver about dangers and, if need be, react autonomously. And our vehicles are becoming ever more intelligent. So with a Mercedes-Benz you are not just driving anywhere – you are driving directly into the future.

BlueEFFICIENCY – fast forward to tomorrow.

Mercedes-Benz brings the future of motoring to the road faster. With ever more efficient vehicles and a production process that wastes fewer and fewer resources. We call this all-encompassing approach BlueEFFICIENCY. By way of example, BlueTEC technology for the diesel engine reduces the nitrogen oxides in the exhaust gases by up to 90%,

while the Natural Gas Drive NGD drastically reduces emissions and fuel costs. Our hybrid models, featuring an intelligent combination of internal combustion engine and electric drive, can reduce fuel consumption significantly. What's more, electromobility is also moving into the fast lane with the SLS AMG Coupé Electric Drive. Meanwhile,

technical and aerodynamic enhancements right down to the last detail make the BlueEFFICIENCY Editions available in selected model series true champions of efficiency.

But every E-Class model already boasts a raft of BlueEFFICIENCY features – holistic vehicle optimisation measures that have been adapted specifically for this model series.



- 1 Efficient alternator recharges in overrun mode.
- 2 Optimised aerodynamics thanks to variable radiator shutter for 4-cylinder models.
- 3 4-cylinder petrol engine with very low fuel consumption (E 200 and E 250).
- 4 Optimised V6 and V8 petrol engines, including direct injection and turbocharging (E 400 and E 500).
- 5 Some diesel and petrol engines already meet the requirements of the Euro 6 emissions standard.
- 6 ECO start/stop function – switches the engine off when at a standstill.
- 7 Fuel consumption history shown as a bar chart on the display (in conjunction with optional COMAND Online).
- 8 Electromechanical Direct-Steer system only requires energy when actually steering.
- 9 ECO display.
- 10 Tyres with optimised rolling resistance (depending on the particular wheel and tyre combination).

Diesel engines.

Maximum pulling power and extremely smooth-running – with lower fuel consumption and emissions: the diesel engines for the E-Class combine these characteristics – something which was considered impossible for a long time.

4-cylinder in-line engines. The 4-cylinder diesel power-plant, available with a choice of three power outputs, displays contemporary qualities, including impressively rich torque and low fuel consumption. This is made possible by a complete package of consumption-reducing technologies.

The current-generation common-rail diesel technology impresses by virtue of an injection pressure increased to up to 2000 bar, optimised combustion chambers, and extremely fast and precisely controlled piezo injectors. High torque is available in every engine speed range thanks to the high ignition pressure and the turbocharger, while the requisite refinement comes courtesy of two Lanchester balancer shafts. The radiator shutter reduces the air resistance if the engines require only moderate cooling.

The 4-cylinder diesel engine is available in the following variants:

- In the E 200 CDI with 100 kW (136 hp) and a maximum torque of 360 Nm
- In the E 220 CDI with 125 kW (170 hp) and a maximum torque of 400 Nm
- In the E 220 BlueTEC with 125 kW (170 hp) and a maximum torque of 400 Nm, only as a Saloon model
- In the E 220 BlueTEC BlueEFFICIENCY Edition with 125 kW (170 hp) and a maximum torque of 400 Nm, only as a Saloon model
- In the E 250 CDI with 150 kW (204 hp) and a maximum torque of 500 Nm
- In the E 250 CDI 4MATIC with 150 kW (204 hp) and a maximum torque of 500 Nm

V6 engines. The 170 kW (231 hp) E 300 BlueTEC and the 185 kW (252 hp) E 350 BlueTEC/E 350 BlueTEC 4MATIC boast V6 diesel engines with particularly low-emission BlueTEC technology. Fast and precisely switching piezo injectors, a high injection pressure plus a maximum torque of 540 Nm for the E 300 BlueTEC and 620 Nm for the E 350 BlueTEC mean effortlessly superior pulling power in every driving situation. BlueTEC is currently one of the cleanest diesel drive systems, thanks to the cleaning and aftertreatment of exhaust gases, resulting in exemplary emission figures and classification as emissions class Euro 6.

In addition, the ECO start/stop function ensures that the engine is stopped temporarily when the vehicle is at a standstill, and thus saves fuel. Furthermore, the ECO display in the instrument cluster provides information about the efficiency of your driving style and recommends gear changes for even greater efficiency.



The optimised E 350 BlueTEC combines its high pulling power with appropriately low consumption and emission figures.

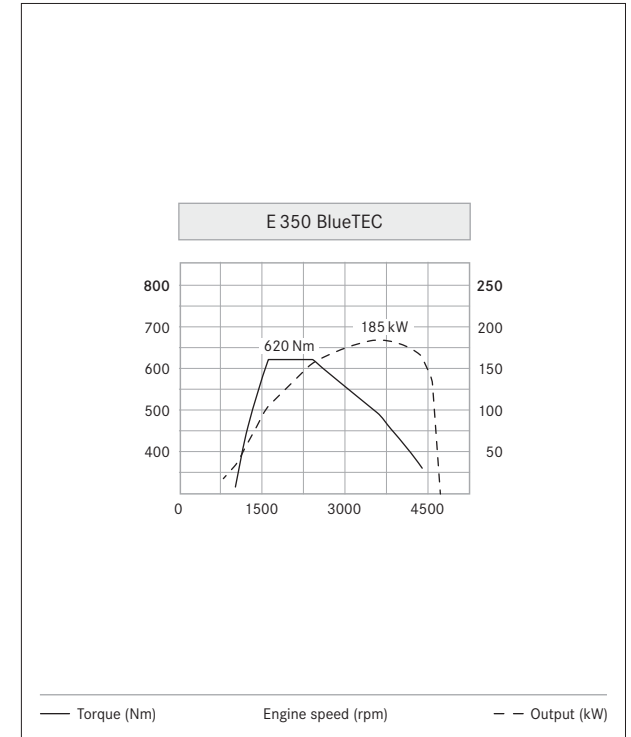

The E 350 BlueTEC reaches its peak torque quickly.

Petrol engines.

Highly developed efficiency – more agility and motoring pleasure coupled with lower fuel consumption: a wide selection of petrol engines with innovative technologies reduces the burden on the environment ever further. The ECO start/stop function which comes as standard with all of the petrol models makes this tangible each time you come to a halt.

4-cylinder in-line engines. The 4-cylinder petrol engine with direct injection, variable valve control and turbocharging boasts better output and torque figures than its predecessor as well as low consumption and emission figures. The multiple direct petrol injection with fast-switching piezo injectors optimises the air/fuel mixture, thus facilitating almost complete combustion of the fuel. The reduced engine weight plus the lower internal friction also contribute to the reduction in fuel consumption and emissions, as does the standard-fit ECO start/stop function.

The 4-cylinder petrol engine comes with a choice of two power outputs:

- In the E 200 with 135 kW (184 hp) and a maximum torque of 270 Nm (manual transmission) or 300 Nm (7G-TRONIC PLUS)
- In the E 250 with 155 kW (211 hp) and a maximum torque of 350 Nm

V6 engines. The 6-cylinder petrol engines from the BlueDIRECT engine family are now supplemented by the E 400. The twin turbochargers result in a significant increase in the torque and output – with a lower displacement. Fundamentally, all the engines impress with their lower fuel consumption and correspondingly low CO₂ emissions. The third generation of direct injection petrol engines from Mercedes-Benz operates using spray-guided combustion and high-pressure injection. All the engine versions are also optionally available with the all-wheel drive system 4MATIC.

The power outputs of the 6-cylinder petrol engine:

- In the E 300/E 300 4MATIC with 185 kW (252 hp) and a maximum torque of 340 Nm
- In the E 350/E 350 4MATIC with 225 kW (306 hp) and a maximum torque of 370 Nm
- In the E 400/E 400 4MATIC with 245 kW (333 hp) and a maximum torque of 480 Nm

V8 engines. This powerplant in the BlueDIRECT engine family offers what are for this size class comparatively favourable consumption figures. This is also thanks to the lightweight design, the direct petrol injection and the BlueEFFICIENCY technologies. What's more, high-calibre driving dynamics are palpable at all times in the E 500 and E 500 4MATIC, thanks to twin turbochargers and an intercooler. To put this into figures: an output of 300 kW (408 hp), a peak torque of 600 Nm available from just 1 600 rpm and outstanding acceleration. All of which makes for effortless superiority in practically any driving situation.

The power outputs of the AMG V8 engines:

- In the E 63 AMG/E 63 AMG 4MATIC with 410 kW (557 hp) and a maximum torque of 720 Nm
- In the E 63 AMG S-Model 4MATIC with an immense 430 kW (585 hp) and a maximum torque of 800 Nm

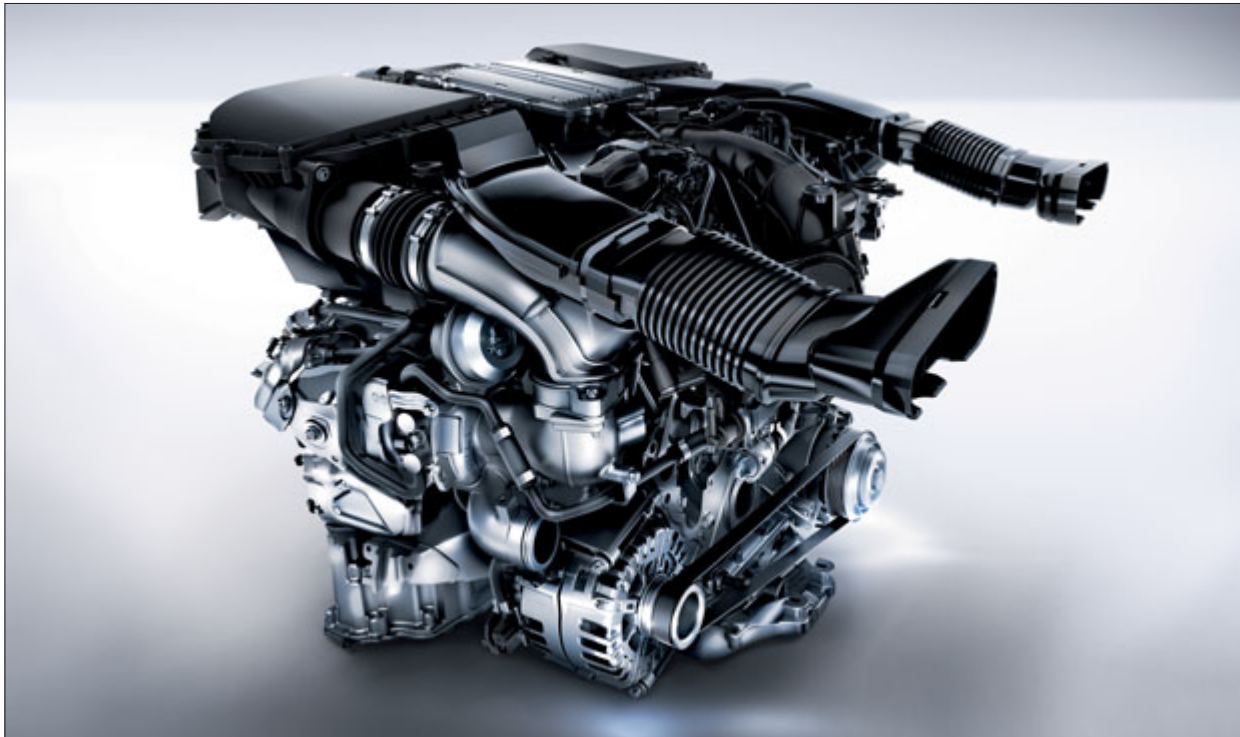

The E 400 has a peak torque of 480 Nm – and supreme pulling power on tap in every driving situation.

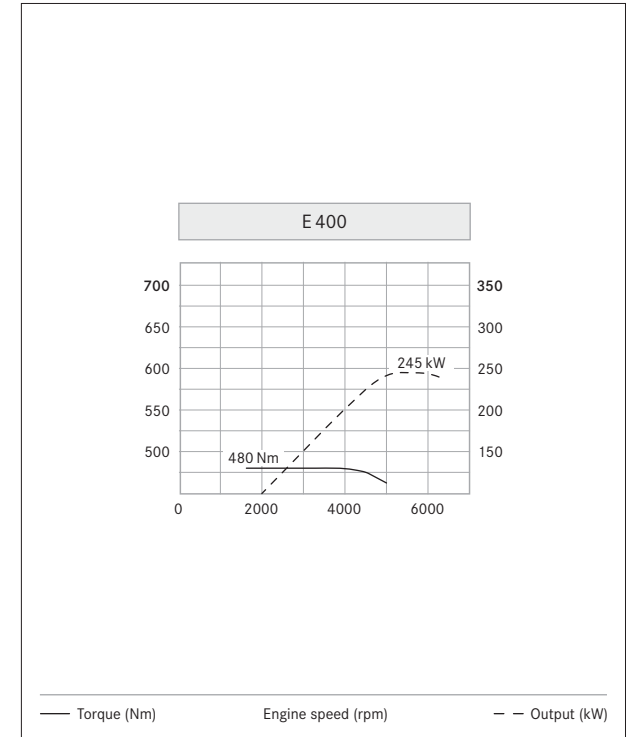

The E 400 offers the ideal combination of driving enjoyment and efficiency.

Alternative drive systems.

Mercedes-Benz underlines its innovative prowess with technologies that lower fuel consumption and further reduce CO₂ emissions. With the E 300 BlueTEC HYBRID, which intelligently combines both a diesel engine and an electric motor; or the E 200 Natural Gas Drive, whose engine can be powered either by petrol or by natural gas.

E 300 BlueTEC HYBRID. Available as both a saloon and as an estate, the E 300 BlueTEC HYBRID is one of the most efficient models in its class. The 4-cylinder diesel model boasts 150 kW (204 hp) and a peak torque of 500 Nm. Together with a compact electric motor with 20 kW and 280 Nm, the result is an efficient overall concept. To put this into figures: combined consumption of 4.2–4.1 litres per 100 kilometres. Exemplary CO₂ emissions are almost a matter of course, as is the familiarly generous space concept. The hybrid concept offers a unique driving experience. The internal combustion engine can be disconnected from the powertrain whilst driving, thus allowing emission-free “sailing” at speeds of up to 160 km/h. Electric driving

at low speed reduces fuel consumption, especially in stop-and-go traffic or when driving at constant speed. For rapid acceleration, the electric motor assists the diesel engine, making more torque available. Optimum control of the link-up between the diesel engine and the electric motor is assured automatically.

E 200 Natural Gas Drive. You can relax when driving with natural gas. In the E 200 Natural Gas Drive the bivalent drive system boasts low CO₂ emissions of 120–116 g/km in gas operation and will reach destinations up to 1350 km away. This is thanks to a frugal, turbocharged 2-litre engine which, in contrast to a pure petrol engine, has been

expanded to include a central injection channel for gas operation. The engine delivers a powerful 115 kW (156 hp) of output and has a maximum torque of 270 Nm. The engine has strikingly quiet yet powerful running characteristics; and the driver can only tell from looking at the display whether the engine is running on petrol or natural gas at any given time. The driver may, of course, choose which tank is feeding the engine simply by pressing a button. And with a boot capacity of 400 litres, the E 200 NGD is not just a low-consumption vehicle with a long range, but a classic touring saloon.



Transmissions.

The 6-speed manual transmission as well as the 7G-TRONIC PLUS and new 9G-TRONIC automatic transmission are precisely tuned to every engine. What's more, they all impress with their intuitive and ergonomic operability.

6-speed manual transmission. The 4-cylinder models (except E 250 CDI 4MATIC, E 300 BlueTEC HYBRID and E 250) are paired with a 6-speed manual transmission as standard, offering impressively short and precise shift travel and facilitating sporty, rapid gear changes. Here the gear ratios and the rear axle ratio are optimally tuned to the engine output in each case. A display on the instrument cluster indicates recommended gear changes to further encourage a highly efficient driving style.

7G-TRONIC PLUS. The E 250 CDI 4MATIC, E 300 BlueTEC HYBRID and E 250 models, as well as the V6 and V8 models, are equipped with the 7-speed automatic transmission 7G-TRONIC PLUS as standard. The transmission is controlled using the DIRECT SELECT lever, while

the driver is able to influence the gear changes using the steering-wheel shift paddles. The seven forward gears allow an optimum engine speed at all times, thus helping to reduce fuel consumption. Compared to the preceding 7G-TRONIC transmission, the electrohydraulic control unit has been enhanced, while the engine and transmission software has been optimised, resulting in further improved gear shift dynamics and gearshift quality. Furthermore, the 7G-TRONIC PLUS gives the driver more direct vehicle response to changes in the accelerator pedal position.

9G-TRONIC. The 9-speed automatic transmission system is available as standard with the E 350 BlueTEC. The system, with nine forward gears, is impressive for its fast and finely-tuned gearshifts, providing the ultimate in shift quality.

Its high level of efficiency makes average savings of 6.5% in consumption and emissions possible compared to the 7G-TRONIC PLUS. This makes an important contribution to its ecological way of driving – without, however, compromising driving enjoyment.

ECO start/stop (standard). The engine is automatically switched off whenever the vehicle is at a standstill – in this simple way the ECO start/stop function achieves a considerable reduction in fuel consumption and emissions, for instance when stopped in a traffic jam or at traffic lights.

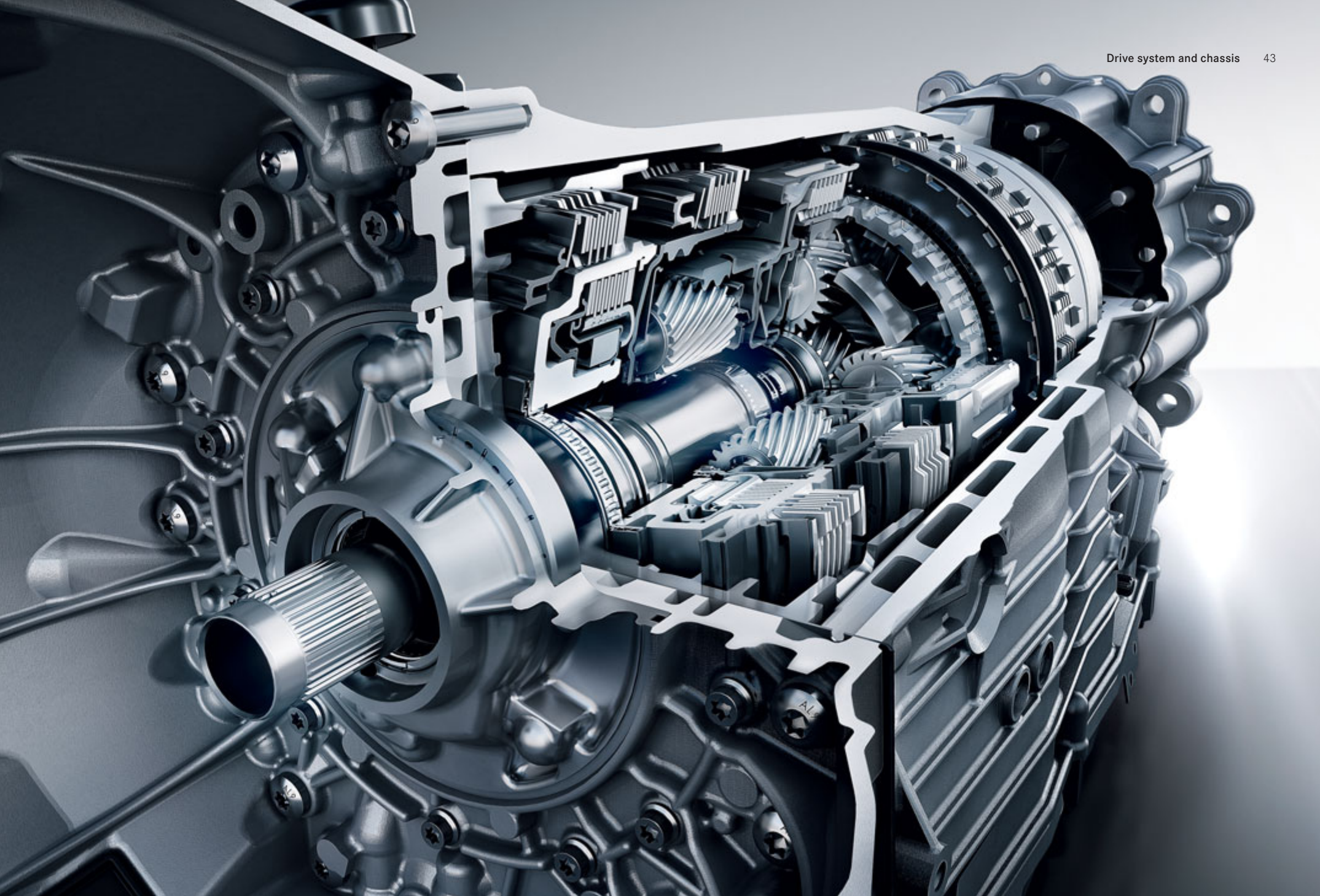

Chassis & suspension.

The optionally available permanent all-wheel drive system 4MATIC provides impressive traction as well as enhanced driving stability. The DIRECT CONTROL suspension and the AIRMATIC air suspension really come into their own on the road. They offer a high level of comfort and are also tuned to ensure a sporty driving style and driving enjoyment.

4MATIC (optional). As the all-wheel drive system 4MATIC is always active, it responds almost instantaneously in poor weather conditions such as rain, black ice or snow. 4MATIC is assisted by the Electronic Stability Program ESP^{®1} and the electronic traction system 4ETS. The latter enables controlled braking of spinning wheels and, as a consequence, increases the drive torque at the wheels

offering good traction, allowing plenty of power to be planted on the road when moving off and when accelerating, even on poor road surfaces. 4MATIC makes conventional differential locks superfluous: the automatic braking pulses make it easier to move off on slippery ground as well as enhancing stability during critical manoeuvres. A further advantage of the system is the fact that it is hardly any

heavier than the rear-wheel drive version on account of the compact design, intelligent choice of materials and high level of efficiency. 4MATIC is available for the E 250 CDI model as well as in conjunction with the V6 and V8 engines (E 350 BlueTEC, E 300, E 350, E 400 and E 500).

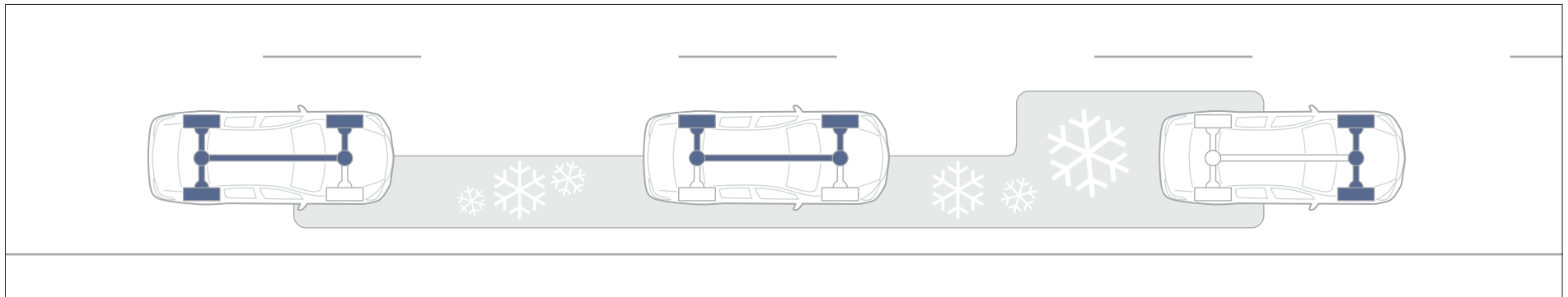

The electronic traction system 4ETS sends the drive torque to the wheels offering sufficient grip and thus facilitates even better traction in wet conditions, on ice or in snow.

¹ Integral component of Mercedes-Benz Intelligent Drive. More on page 34.

DIRECT CONTROL suspension (standard). The DIRECT CONTROL suspension with selective damping system combines agility and ride comfort, as the damping effect is adjusted to suit the current driving situation. The enhanced damping and vehicle stability are particularly noticeable – and welcome – on poor road surfaces. The DIRECT CONTROL suspension has sports tuning and the body has been lowered

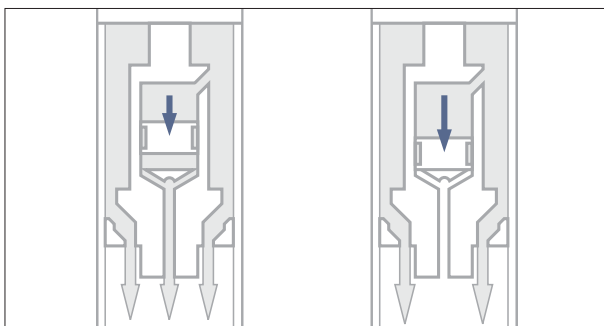

Blends agility with a high level of comfort – the DIRECT CONTROL suspension adjusts the shock absorbers automatically.

by 15 mm (standard with the AVANTGARDE line). The E-Class Estate features air suspension with integral level control on the rear axle. Fitted as standard, this system ensures constant spring travel and ground clearance – irrespective of the vehicle load.

Direct-Steer system (standard). The Direct-Steer system has a more direct steering ratio in the case of large steering angles and reduces the steering effort required, for example when taking tight bends, thus enhancing the car's agility and steering comfort.

AIRMATIC (optional for 4- and 6-cylinder models, standard for E 500/E 500 4MATIC). AIRMATIC air suspension, with adaptive shock absorbers, adapts itself automatically in line with the current road conditions, vehicle load and driving situation. The driver can also select comfort-oriented plus sporty settings manually – for improved roadholding and individual driving enjoyment.

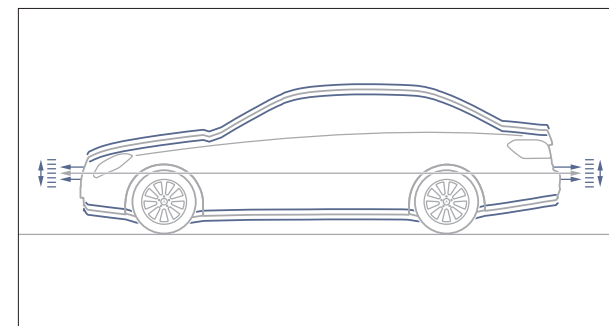

AIRMATIC keeps the vehicle at a constant ride height, irrespective of the vehicle load, or it can lower and raise the ride height as and when required.

Integral safety concept.

The vision of accident-free driving drives us forward. Our integral safety concept brings us a step closer to achieving this aim – a comprehensive approach that can enhance safety in any situation.

As the inventor of the car we feel that we have a special responsibility for road safety. This is why we are the first car manufacturer to have developed an integral safety concept which seamlessly blends active and passive safety measures for comprehensive protection. This extensive concept is split into four phases and provides safety solutions for almost any situation. It includes systems for safe driving which help to avoid risks by warning you and coming to your aid in good time. Our unique PRE-SAFE® system¹ kicks in in the event of danger and activates preventive measures for occupant protection. If a collision should still occur in spite of all the preventive measures, further technologies ensure protection as needed. We have also borne in mind the time immediately following an accident and developed solutions which can help prevent worse things happening and facilitate rapid help.

A selection of these technologies for the “Safe driving”, “In the event of danger”, “In an accident” and “After an accident” phases is presented on the pages which follow.

Safe driving: ATTENTION ASSIST¹ (standard). This attention detection system can be useful on long trips in particular. Between 60 and 200 km/h sensors analyse driving behaviour and can detect deviations from a previously determined, individual driver profile, enabling timely alerts in the event of serious lapses in concentration or increasing drowsiness. A dedicated menu in the instrument cluster provides the driver with additional information.



If signs of increased driver drowsiness are detected, ATTENTION ASSIST advises taking a break.

Safe driving: LED headlamps (standard). The lighting units with LEDs for the headlamps, daytime running lamps and position light ensure maximum brightness in road traffic, whilst at the same time offering less glare, minimum energy consumption and a longer life. The LED Intelligent Light System¹ (optional) can also flexibly adjust the light distribution to the driving situation and the course of the road, and all the light functions here feature LED technology.



The efficient LED technology for the headlamps is available in two versions.

¹ Integral component of Mercedes-Benz Intelligent Drive. More on page 34.

Safe driving: Adaptive Highbeam Assist Plus¹ (optional).

When there are oncoming vehicles or vehicles in front, part of the main beam light cone is left out so as not to dazzle other road users. This means that the main beam can also be used when there is oncoming traffic and traffic in front of you. Over and above this, the control function dims main beam where there are highly reflective signs at the edge of the light beam.

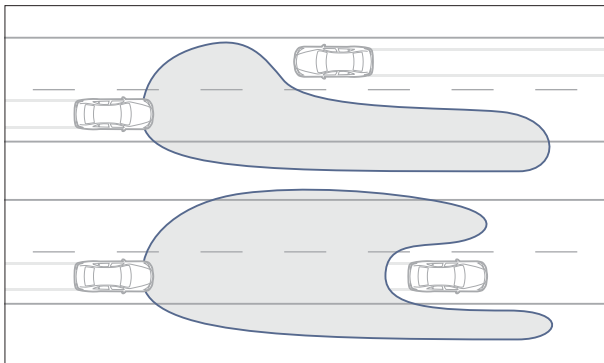

Adaptive Highbeam Assist Plus always provides the best possible headlamp range automatically.

Safe driving: Driving Assistance package Plus¹ (optional).

DISTRONIC PLUS with STEER CONTROL¹ assists the driver at speeds of 0 to 200 km/h by maintaining the desired distance from the vehicle in front. STEER CONTROL makes the driver's job easier by helping with lane guidance and allows semi-autonomous driving when following a traffic jam. Further components include PRE-SAFE[®] Brake¹ with pedestrian protection, Active Lane Keeping Assist, Active Blind Spot Assist¹ and BAS PLUS with Cross-Traffic Assist¹.

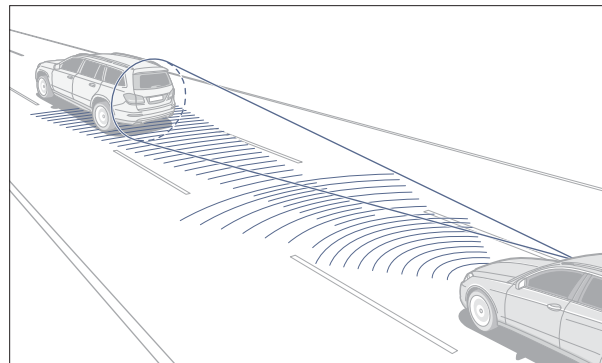

The DISTRONIC PLUS proximity control with STEER CONTROL can brake the car to a standstill and then start the car moving again.

Safe driving: Lane Tracking package¹ (optional).

Lane Keeping Assist (available as an option) recognises the continuous white lines as well as broken lane markings. The system can warn the driver via vibrations on the steering wheel if they leave their lane unintentionally. The Blind Spot Assist¹ (optional extra) monitors the blind spot alongside the vehicle from a speed of 30 km/h and can give audible and visual warnings if dangers are detected in this area.

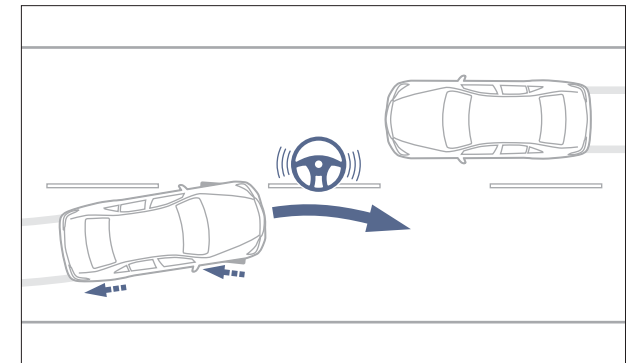

Active Lane Keeping Assist can warn the driver against leaving their lane unintentionally and help keep the car in its lane.

In the event of danger: PRE-SAFE® anticipatory occupant protection system (standard). The preventive occupant protection system is able to recognise critical driving situations in advance and, as a precaution, it can activate safety systems. To do this, the PRE-SAFE®¹ system continuously monitors sensor data from systems such as the ESP®¹ and BAS¹, and can thus, for example, analyse driving situations such as oversteer/understeer as well as emergency braking. If a critical driving situation is detected, in fractions of seconds the belts on the front seats can be reversibly tensioned and the side windows automatically closed, so that the belts and airbags are able to deploy their full protective effect should an impact occur. In addition to this the enhanced PRE-SAFE® PLUS¹ system (integral component of the optional Driving Assistance package Plus¹) can also use a radar sensor in the rear bumper to detect potential hazards in the rear area and initiate additional effective safety measures. If an impact is imminent, the rear indicators flash at a faster frequency to warn the traffic behind. Furthermore, the vehicle is, for instance, stalled in order to prevent secondary collisions to the front in the case of any rear-end collisions which may occur. This also lessens the forces exerted on the occupants by the forwards jolt.

¹ Integral component of Mercedes-Benz Intelligent Drive. More on page 34.

² Available in 19 European countries for the entire life of the vehicle.

In the event of danger: COLLISION PREVENTION ASSIST¹ (standard). The system can detect insufficient distance between the car and the vehicle in front and then give the driver an audible warning. If there is a risk of a collision with a slower moving or stopping vehicle within defined speed ranges, the driver receives audible and visual warnings. During braking, Active Brake Assist can provide the braking force required to avoid an imminent collision or at least reduce its severity.

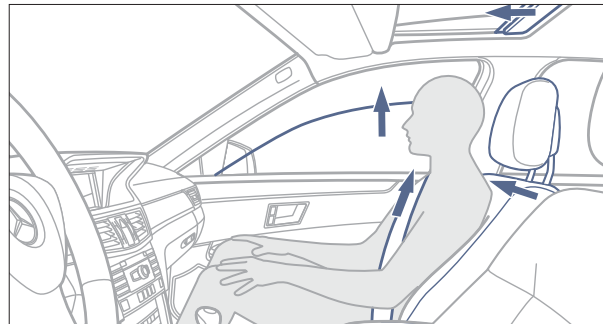

The PRE-SAFE® anticipatory occupant protection system can recognise critical driving situations and initiate measures to protect the occupants.

In the event of danger: BAS PLUS with Cross-Traffic Assist¹ (integral component of the optional Driving Assistance package Plus). The anticipatory braking assistance system BAS PLUS¹ calculates the braking pressure which is required in order to prevent a collision or reduce the severity of the accident. It then initiates partial or even full braking if the driver does not hit the brakes hard enough. BAS PLUS can also intervene to provide assistance in situations involving crossing vehicles. Plus the system can detect pedestrians in the area ahead of the vehicle and augment the braking power applied when the driver presses the brake pedal if necessary.

In the event of danger: PRE-SAFE® Brake with active pedestrian detection¹ (integral component of the optional Driving Assistance package Plus). As a three-stage warning and braking system PRE-SAFE® Brake is able to intervene before an impending rear-end collision at speeds of up to 200 km/h: if the driver fails to react to a first warning, autonomous partial braking is performed. The system can then trigger autonomous emergency braking if there is still no reaction from the driver. Autonomous braking can help prevent rear-end collisions with stationary vehicles and collisions with pedestrians in the area ahead of the car at speeds of up to 50 km/h.

In an accident: active bonnet (standard). The active bonnet can reduce the risk of injury to pedestrians or cyclists if they are involved in a collision with the bonnet in a speed range between 25 and 55 km/h. To cushion the blow, the bonnet is raised approximately five centimetres at the rear, which can reduce the risk of severe injuries.

In an accident: airbags (standard). 3-point seat belts, belt tensioners, belt-force limiters and airbags are optimally coordinated with each other. Nine airbags can all help to prevent injuries. In order to protect the occupants two adaptive front airbags are installed, which are deployed depending on the severity of the accident. What's more, there are sidebags and pelvisbags fitted in the front seats, and two large windowbags are also integrated. The knee-bag can further reduce the forces exerted on the driver during an accident. Belt tensioners and belt force limiters are fitted as standard for the outer rear seats. The optional Rear Seat Safety package provides additional protection in the form of sidebags which are fitted in the rear on the left and right hand sides.

In an accident: NECK-PRO head restraints (standard). The NECK-PRO head restraints for the driver and front passenger can be activated in a rear impact: a spring mechanism moves the head restraints forwards and upwards; the head can thus be supported earlier and the strain on the spine can be reduced.

After an accident: Mercedes-Benz emergency call system² (component of COMAND Online). This system can make an emergency call automatically using a mobile phone which is on standby and connected to the vehicle as soon as the restraint system detects an accident. At the same time, the GPS position data and other data about

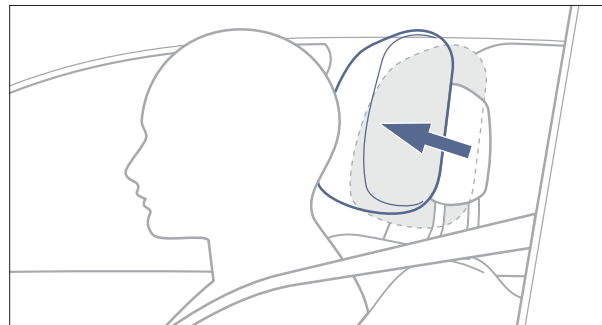

The NECK-PRO head restraints can reduce the risk of whiplash significantly in a rear impact.

the vehicle are transmitted to the Mercedes-Benz emergency call centre, after which a voice connection is established. The emergency call system can also be triggered manually.

Measures after an accident. In order to reduce consequential damage and, where necessary, to support the rescue of the occupants, Mercedes-Benz has developed further measures. These include the automatic engine cut-off or the activation of the hazard warning lamps and the emergency interior lighting. The central locking also opens automatically, and crash joints between the door and the wing make it easier to open the doors after an accident. In addition Mercedes-Benz makes Guidelines for Rescue Services available; helpers can download them in different languages all over the world from the internet at www.mercedes-benz.de/rettungsleitfaden. As you can see, at Mercedes-Benz consideration has been given to safety in every situation.

E-Guard.

The E-Class Saloon with ex-factory ballistic protection continues the tradition of armoured vehicles at Mercedes-Benz, which stretches back more than 80 years. When it comes to your personal protection, the E-Guard is just the one for the job.

Mobile protection – the E-Guard. Tested and certified by internationally recognised official organisations in accordance with ballistic protection level VR4 and higher – fore-armed for extreme situations. Like every Mercedes-Benz Guard model, the E-Guard has been designed specifically for its own operating conditions. It may look exactly like a series-production model on the outside, but this outer skin conceals a whole network of protective components. In order to achieve the same structural rigidity, dimensional accuracy, corrosion protection and surface quality as for the series-production models, the E-Guard passes

through the same body stations on the assembly line. As a fully-fledged 5-seater, the E-Guard Saloon provides all the space and comfort you would expect. Virtually all the comfort and safety features available for the series-production models can be ordered. Refinement and dynamism are also on a par with the E-Class. The available engines range from a V6 diesel to a V8 petrol engine with twin turbochargers. Plus there is a vast selection of individually configurable optional extras all designed to enhance the level of protection offered by the E-Guard.

One of the ballistic tests involves checking the E-Guard for resistance to projectile penetration. And it goes without saying that the car also has to pass all the usual Mercedes quality and safety tests as well as display full everyday practicality. What's more, all the safety components – such as the electronic control systems, the brakes, the chassis and the suspension – have been adapted to take into account the vehicle's heavier weight. The E-Guard is therefore an impressive combination of protection and comfort, as one would expect from a Mercedes.



Multimedia systems.

The multimedia functions in the E-Class can be operated intuitively via an easy-to-use Controller located on the centre console, via buttons on the devices themselves or the multifunction steering wheel.

COMAND Online (optional). The multimedia system boasts a high-resolution 17.8 cm display with TFT technology and a flat-frame look. The system's functions include a radio, speed-sensitive volume control, the Music Register with a 10 GB hard disc, hard-disc navigation and free European map data updates for three years. The online function facilitates access to the internet and Mercedes-Benz mobile services via an internet-enabled mobile phone. In this way the Live Traffic Information¹ service receives up-to-the-minute, precise traffic information in real time, enabling optimised dynamic route guidance and more accurate ETA information. The data for this is transferred with the help of a communication module with an integral SIM card, which provides the connection to the internet, including data roaming. A USB connection, a slot for SD memory cards and a Bluetooth® interface and the optional Media Interface allow connection to external data storage media. And with the optional telephone module the system can also be fitted with its own SIM card. Navigation is via the COMAND Controller and via the multifunction steering wheel. With LINGUATRONIC,

¹ 3 years* use free of charge, available in 12 countries.

COMAND Online can also be controlled by voice entry. The Digital Owner's Manual contains the complete descriptions for operating the vehicle and the COMAND Online system. It can be called up quickly and easily via the system.



COMAND Online is a combination of audio and navigation systems as well as telephone functions.

SPLITVIEW (optional). SPLITVIEW is a display technology that allows the driver and front passenger to each see a different picture on the same screen. While the driver looks at navigation information, for example, the front passenger can compile their own personal entertainment programme and listen through wireless headphones.



SPLITVIEW displays two different images at the same time – for the driver and front passenger – on a single screen.

Becker® MAP PILOT (optional). The Becker® MAP PILOT allows the Audio 20 CD to be extended, making it a fully fledged built-in navigation device. A GPS receiver and computer unit form part of the device. The system is operated via the central Controller in front of the armrest, whilst addresses can also be entered via speech. Current map data are available via a simple update from the internet.



Audio 20 CD with optional Becker® MAP PILOT.

Harman Kardon® Logic 7® surround sound system (optional). The 610-watt high-performance system with fully digital surround sound turns every journey into an acoustic experience, too. 14 high-performance loudspeakers, Logic 7® multi-channel surround sound technology plus the automatic volume adjustment offer listening pleasure that is optimally tuned to the interior of the vehicle.



Harman Kardon® Logic 7® surround sound system.

Bang & Olufsen BeoSound AMG (optional). With 15 high-performance loudspeakers, a 16-channel DSP amplifier and an ICEpower amplifier this 1200-watt high-end surround sound system ensures first-class acoustics. The surround sound playback can be individually adjusted to the entire passenger compartment. 3D surround sound and speed-sensitive volume control ensure constant listening pleasure.



15 loudspeakers and 1200 watts delight the ears: the Bang & Olufsen high-end sound system.

Assistance systems.

Just like in real life: assistance systems are tasked with making our life easier. In this respect, features such as the 360° camera, the Traffic Sign Assist and the Active Parking Assist enhance the feeling of comfort and safety in the E-Class.



The 360° camera system uses four cameras to provide views all around the vehicle.

Parking package with 360° camera¹ (optional).

The Parking package includes the 360° camera, as well as Active Parking Assist including PARKTRONIC. The Parking package with the 360° camera feature comprises a close-range camera system with four networked cameras and a control unit which can display a homogenous all-round view. One camera is mounted at the front, there is one in each exterior mirror and one in the centre at the rear of the car. Based on the information, the system calculates various views around the vehicle as well as a true-colour image of the vehicle and its surroundings from a bird's-eye perspective. The different perspectives can be selected using the COMAND Controller. The 360° camera is activated when reverse gear is engaged or by selecting it in the COMAND system. The images appear on the multimedia system display and can be changed automatically depending on the direction of travel. Dynamic guide lines make it easier to get one's bearings and help with manoeuvring back onto a trailer's drawbar if a trailer coupling is fitted, for example.

¹ Integral component of Mercedes-Benz Intelligent Drive. More on page 34.

Traffic Sign Assist¹ (option in conjunction with COMAND Online). A camera registers the surroundings, can detect signposted speed limits by comparing with data from the navigation system, and indicate the detected maximum speed on the instrument cluster and central display. Furthermore, other traffic signs – like those indicating additional speed limit information and “no overtaking” signs, signs signalling the end of restrictions and “no entry” signs (currently only applies to Germany) – can be detected and displayed.



As well as speed restrictions, the Traffic Sign Assist also indicates “no overtaking” signs and “no entry” signs at motorway junctions.

Reversing camera¹ (optional). The reversing camera records the area immediately behind the vehicle. It automatically switches itself on when reverse gear is engaged and affords the driver more safety when parking. Static and dynamic guide lines help when manoeuvring. The reversing camera is only available in conjunction with the COMAND Online, which also comes as an option.



During parking, the COMAND Online central display shows the area behind the car.

Active Parking Assist with PARKTRONIC¹ (optional). When driving slowly, twelve ultrasonic sensors monitor the surroundings and can detect suitable parking spaces, indicating them in the instrument cluster. A control unit processes the signals and calculates the best line to take to get into the space. Additionally the E-Class offers functions for automatically entering perpendicular parking spaces and for automatically entering and exiting parallel parking spaces with active steering and braking intervention.



The display in the instrument cluster gives a clear picture of the parking manoeuvres at all times.

Climate control.

A pleasant interior climate is paramount when it comes to ensuring a high level of driver-fitness safety. The climate control system for the E-Class is therefore exceptionally versatile and can be adjusted to meet the needs of each individual occupant.

THERMATIC (standard). The THERMATIC automatic climate control system controls the temperature and ventilation separately for the driver and front passenger with the aid of sensors. For example, a sun sensor on the windscreen registers the intensity of the sun and the beam direction. Also standard: air recirculation, a cooled glove compartment and the particulate matter activated charcoal filter,

which filters out dust, soot and pollen and reduces odours and pollutants in the air, plus improves overall air quality.

THERMOTRONIC (optional). The THERMOTRONIC luxury automatic climate control system (standard for V8 models) allows the driver, front passenger and rear passengers each to set their own temperature separately; the rear

passengers have their own control unit. The air distribution is separately controllable for the driver and front passenger. The automatic air recirculation ensures good air quality in the vehicle. What is more, the automatic mode can be adapted to individual needs as there are three climate styles to choose from.

Climatised front seats (optional). The airflow for the climatised seats has been configured to ensure a well-balanced seat climate. There is a choice of three-stage seat heating and three-stage active ventilation for cooling the seats. The output of the climatised seats is reduced automatically after a certain time. The settings for the driver and front passenger are controlled separately using the controls on the centre console.



The controls for the THERMOTRONIC luxury automatic climate control system are ergonomic and intuitive.

Seats.

The seats combine ride comfort with ergonomics and safety – both at the front and in the rear.



The active multicontour seats are designed to meet the highest requirements in terms of individual seating comfort, ergonomics and safety.

The front seats with standard-specification NECK-PRO head restraints are ergonomically shaped and provide firm support. Their height and backrest angle can be electrically adjusted. With the optionally available climatized seats the front seats are actively ventilated and heated. In the version which features multicontour seats (optional), for which ventilation and heating are also offered, inflatable air chambers are integrated. The outer rear seats are equipped with belt force limiters and belt tensioners as standard.

Active Multicontour Seat package (optional). The active multicontour seat ensures comfortable driving and lateral support. Air chambers and seat side bolsters adjust dynamically to suit the current driving situation. Further-enhanced comfort is assured by a 7-zone dynamic massage function, NECK-PRO luxury front head restraints, and pneumatic adjustability of the seat cushion length, the backrest side bolsters and the 4-way lumbar support.

Load compartment management.

The E-Class Estate has plenty of stowage space. Intelligent solutions are required to enable this to be used efficiently – such as the EASY-PACK load compartment management system.

EASY-PACK quickfold (standard). For easier loading, there is an actuating lever on the left and right at the D-pillars, enabling the rear seat backrests to be folded down easily from the load compartment. The release handle in the rear seat backrest area is another practical feature: one move is all it takes to fold the backrest forward. Even when it is upright again, the regular boot capacity is an impressive 695 litres (up to 1950 litres when folded down).



Release handle makes light work of folding down the rear armrests.

EASY-PACK folding load compartment floor (standard). Concealed beneath the load compartment floor is an additional stowage space of 132 litres, which can also be used for stowing an optional spare wheel. The principle of the EASY-PACK folding load compartment floor makes it possible to open it in stages, which aids loading.



The EASY-PACK folding load compartment floor facilitates opening in stages.

EASY-PACK load-securing kit (optional). In combination with the second load compartment level, the Estate can be supplied with the EASY-PACK load-securing kit. It includes a telescopic bar which attaches to cargo rails at the sides and allows the load compartment to be divided flexibly into different zones. And items can be secured to the luggage compartment sides using the retractable load-restraining belt. The EASY-PACK rear sill protector can protect the bumper and load compartment sill against scratches and damage during loading and unloading.



More load capacity equals more versatility.



Space.

With its exemplary load compartment concept and up to 1950 litres of load space, the Estate is a class leader in the new generation, too.

EASY-PACK tailgate (standard). The EASY-PACK tailgate can be operated electromechanically. It can be opened at the push of a button on the driver's door, on the tailgate, or by using the ignition key. It can also be closed again using a switch on the tailgate. Plus it can be stopped in a lower position, for example to prevent contact with low garage ceilings.



The EASY-PACK tailgate can also be opened and closed in a lower position at the push of a button.

EASY-PACK load compartment cover (standard).

A combined load compartment cover and net is positioned in the C-pillar area. The load compartment cover, colour-coded to match the interior appointments, shields luggage from the sun and prying eyes. For easy loading, it moves upwards automatically when the tailgate is opening and



The EASY-PACK load compartment cover moves upwards with the tailgate when the latter is opened.

returns to its starting position when the tailgate is closed. Further features in the load compartment enable items to be stowed tidily, for instance nets integrated in the side panelling for the convenient stowage of smaller items and a 12-volt socket providing an additional power supply in the load compartment.



The optional folding bench seat in the load compartment can carry two people, each with a max. height of 140 cm and weight of 50 kg.

Load compartment (standard). The dimensions of the E-Class Estate – with a length of 4.91 metres, a width of 1.85 metres and a height of 1.51 metres – form the basis for its large load compartment. Equipped with the optional folding seat bench in the load compartment, the Estate can either carry up to seven people or transport a load volume of up to 1950 litres. The latter is possible if the rear seat backrests are all folded down. These can, of course, also be folded down separately, with a 1/3 : 2/3 split.

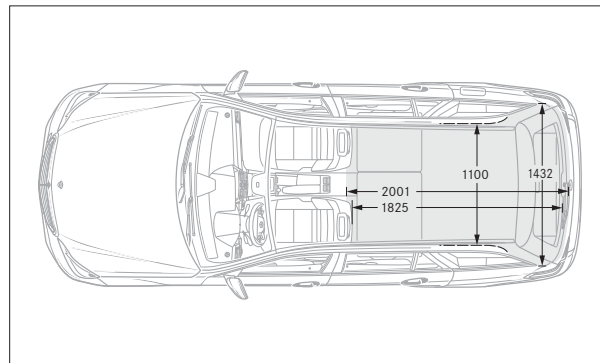

2-seater.

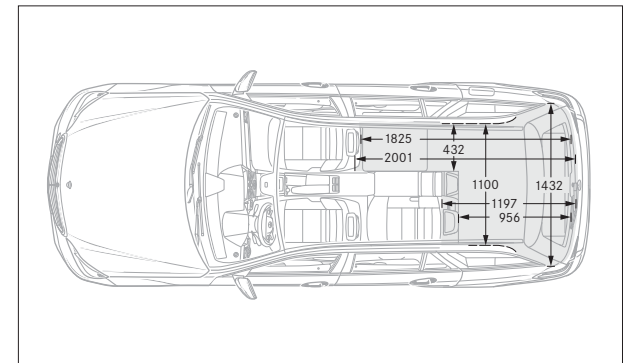

4-seater.

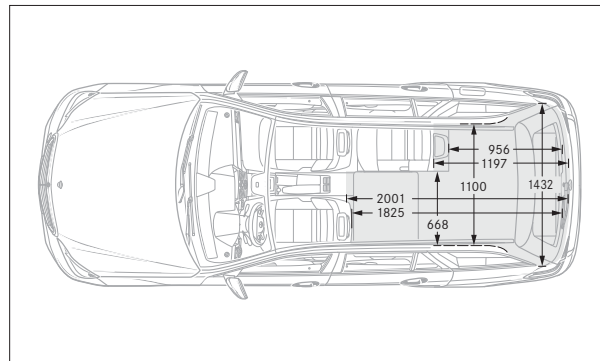

3-seater.

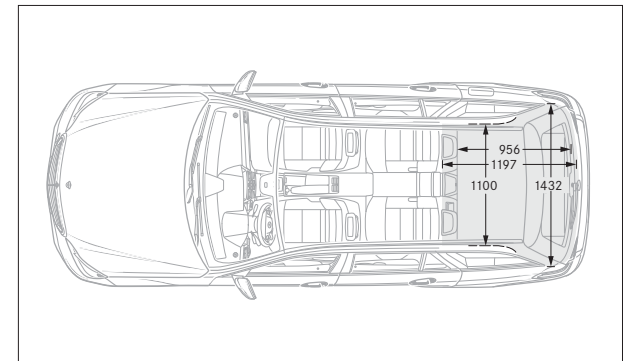

5-seater.



E 63 AMG.

The AMG design idiom signals driving dynamics and offers many different options for differentiation. The E 63 AMG is available both with rear-wheel drive and also with the AMG-specific 4MATIC all-wheel drive system. The AMG SPEEDSHIFT MCT 7-speed sports transmission, with four modes and a “Race Start” function, combines exciting dynamics with impressive efficiency. This exclusive performance is reflected in the interior, too.

Exterior

AMG bodystyling with front and rear apron plus side sill panels

AMG radiator grille with twin louvre in silver chrome and the Mercedes star

AMG sports exhaust system – 2 twin tailpipes in stainless steel with AMG logo

Distinctive flared front wings with “V8 BITURBO” lettering

LED Intelligent Light System

Interior

AMG 3-spoke performance steering wheel in nappa leather

AMG door sill panels in brushed stainless steel with “AMG” lettering

AMG DRIVE UNIT with aluminium E-SELECT lever

AMG instrument cluster, incl. RACETIMER, AMG main menu and AMG Start-up indicator

AMG sports seats in nappa leather offering optimised lateral support

AMG-specific analogue clock in IWC design

Armrests in doors, centre console & door centre panels in nappa leather; dashboard & beltline of doors in ARTICO man-made leather with topstitching

Chrome-look electronic master key with AMG emblem

Upholstery available in black nappa leather (Code 861), silk beige nappa leather (Code 865) or crystal grey nappa leather (Code 868)





E 63 AMG S-Model 4MATIC.

Impressive features reveal the special character of the E 63 AMG S-Model 4MATIC. By way of example, the AMG 5.5-litre V8 biturbo engine has been endowed with 430 kW (585 hp) and 800 Nm. The Saloon covers the sprint from 0 to 100 km/h in a mere 3.6 seconds, and the Estate in 3.7 seconds. The AMG-specific 4MATIC all-wheel drive system ensures rear-biased torque distribution and the best possible combination of traction and neutral handling – an AMG hallmark.

Exterior

10-spoke AMG light-alloy wheels, painted titanium grey matt and rim flange with high-shine finish, with 255/35 R 19 front tyres and 285/30 R 19 rear tyres

AMG front apron with A-wing in high-gloss black, A-wing trim strip and front splitter in silver chrome

AMG rear apron with diffuser fins, trim strip in silver chrome

AMG sports exhaust system in a design unique to the S-Model

Brake callipers painted red

Insert on the side sill panels in silver chrome

“S-Model” lettering on the boot lid

Interior

AMG door sill panel, illuminated with white LEDs at the front

AMG emblem in the front head restraints, embossed

AMG instrument cluster with red appliqué and “S-Model” lettering

Light contrasting topstitching in the case of black upholstery (Code 821)

Silver-coloured seat belts (except in the case of silk beige upholstery)

Upholstery available in silk beige nappa leather or crystal grey nappa leather



E 63 AMG technical details.

The E 63 AMG impresses with its emotive driving feel, dynamism plus power, and always lets the driver choose between a sporty or a more comfort-oriented driving style.

→ www.mercedes-amg.com

AMG 5.5-litre V8 engine. The AMG V8 engine impresses both with its exciting dynamism and with what is a high level of efficiency for an engine with a rated output of 410 kW (557 hp) and torque of 720 Nm. It achieves this through direct petrol injection with spray-guided combustion, biturbocharging, alternator management and the Controlled Efficiency driving program with a start/stop function.



Tried-and-tested technology: the AMG 5.5-litre V8 engine with biturbocharging.

AMG SPEEDSHIFT MCT 7-speed sports transmission.

The high-tech transmission gives you all the freedom you want. For in addition to the “Race Start” function, it also provides four other individual driving programs: “Controlled Efficiency” stands for particularly consumption-optimised driving, the “S” (Sport), “S+” (Sport Plus) and “M” (Manual) programs increase dynamism. They allow for gear changes in less than 100 ms.



The AMG SPEEDSHIFT MCT 7-speed sports transmission.

AMG RIDE CONTROL sports suspension. The wider front axle used for the AMG sports suspension enhances lateral dynamics, while the electronically controlled damping system allows lightning-fast changes between agility and ride comfort. The sports suspension also impresses with its individuality. Available for selection are the suspension modes “Comfort”, “Sport” and “Sport Plus”. Over and above this, drivers have the opportunity to determine for themselves the support from the dynamic driving system ESP^{®1} in three stages.

AMG-specific 4MATIC all-wheel drive system. The effortlessly superior output of the AMG 5.5-litre V8 biturbo engine can be combined with a performance-oriented 4MATIC all-wheel drive system developed by Mercedes-AMG. The torque distribution is 33% (front axle) to 67% (rear axle). This means that neutral cornering is ensured even during powerful acceleration. Depending on the ESP[®] stage selected, wheel-selective brake actuations counteract the understeer, thus making sure that the vehicle turns into the centre of the bend agilely and at the same time comfortably.

¹ Integral component of Mercedes-Benz Intelligent Drive. More on page 34.





AMG Performance Studio.

In order to emphasise the sporty side of the E 63 AMG to an even greater extent, the AMG Performance Studio offers a wide range of individually selectable optional extras. The AMG Performance Studio even meets customer requirements regarding personalised vehicles – right down to unique one-off specimens.



10-spoke AMG light-alloy wheels, painted matt black and rim flange with high-sheen finish (Code 752), with 255/35 R 19 front tyres and 285/30 R 19 rear tyres

5-twin-spoke AMG forged wheels with a wheel bolt cover, painted titanium grey and surfaces with a high-sheen finish (Code 785), with 255/35 R 19 front tyres and 285/3 R 19 rear tyres

AMG carbon-fibre engine cover

AMG ceramic high-performance compound braking system with a weight saving of around 40% and the life of the brake discs increased several times over

AMG Driver's package with top speed increased to 300 km/h (Saloon)/280 km/h (Estate) and participation in a driver training session at the AMG Driving Academy

AMG performance steering wheel in black nappa leather/Alcantara®

AMG rear-axle limited-slip differential for better traction and lateral dynamics (standard in the case of the E 63 AMG S-Model 4MATIC)

AMG RIDE CONTROL performance suspension (only for E 63 AMG Saloon)





E 63 AMG packages.

AMG Night package. It emphasises the expressivity and sportiness of the E 63 AMG in an extravagant way: The A-wing and the front sliver are painted in high-gloss black, as are the inserts in the AMG side sill panels, the exterior mirror housings and the trim strip on the rear apron. The thrilling conclusion comes in the form of two black twin tailpipe trims in stainless steel featuring a V8 design, or, in the case of the E 63 AMG S-Model 4MATIC, in the specific design for the S-Model.



Elements of the AMG Night package

A-wing, trim strip and front splitter of the AMG front apron in high-gloss black

AMG sports exhaust system with 2 black twin tailpipe trims in stainless steel featuring a V8 design or a specific design for the S-Model in the case of the E 63 AMG S-Model 4MATIC

Exterior mirror housings in high-gloss black

Inserts in the side sill panels in high-gloss black

Trim strip in AMG rear apron in high-gloss black

AMG Exterior Carbon-Fibre packages I and II. Boasting an array of sporty details, the two AMG Exterior Carbon-Fibre packages deliver a visible luxury dimension to the E 63 AMG with sporty details and lend the vehicle considerably more dynamism in visual terms. They offer an effective contrast to the vehicle paint finish and emphatically underline its motorsport credentials.



Elements of the AMG Exterior Carbon-Fibre package I

AMG front apron A-wing in carbon fibre

Insert in AMG side sill panels in carbon fibre

Upper panel of the AMG rear apron in carbon fibre

Elements of the AMG Exterior Carbon-Fibre package II

AMG spoiler lip in carbon fibre (only for E 63 AMG Saloon)

Exterior mirror housings in carbon fibre





Standard equipment.

The E-Class turns heads, and this starts with the expressively styled front section. The interior also impresses with its 3-tube instrument cluster, centre console with an analogue clock and central display featuring a contemporary flat-screen look. Technologies such as the Direct-Steer system, the ATTENTION ASSIST¹, the COLLISION PREVENTION ASSIST¹ plus the PRE-SAFE[®] anticipatory occupant protection system make the vehicle as sophisticated as it is safe.



Exterior

9-spoke light-alloy wheels

DIRECT CONTROL suspension, comfort-tuned

LED daytime running lamps

Radiator grille in stone grey with 3 chromed louvres

Shoulderline trim strip in chrome look

Tail lights with LED technology

Interior

3-tube instrument cluster with 5 analogue round dials

Ambient lighting, single-tone

Analogue clock with Mercedes star in the centre console

Electrically adjustable front seats

Light longitudinal-grain aluminium trim

Multifunction steering wheel trimmed in nappa leather, with 12 buttons, 4 spokes, with two chrome inserts

Strasbourg fabric upholstery, seat design with horizontal seamlines



¹ Integral component of Mercedes-Benz Intelligent Drive. More on page 34.



The standard specification includes upholstery in fabric, whereby there is a choice between the colour schemes black and crystal grey. Over and above this customers can choose between optional seat covers in ARTICO man-made leather or in real leather. Here there are also two upholstery colours available respectively, which can also be found on the insides of the doors, the lower part of the dashboard plus the carpet. The beltline and the upper part of the dashboard are both in black. In addition, the steering wheel plus the shift lever (in conjunction with the 6-speed manual transmission) are covered with nappa leather.

black

- 011 Strasbourg fabric
- 111 ARTICO man-made leather¹
- 211 Leather¹
- 241 Leather²
- 611 ARTICO man-made leather/DINAMICA microfibre²

crystal grey/seashell grey

- 018 Strasbourg fabric
- 118 ARTICO man-made leather¹
- 218 Leather¹

Trim

- H76 Light longitudinal-grain aluminium
- H09 Open-pore brown ash wood¹
- H14 High-gloss brown burr walnut wood¹
- H73 AMG carbon fibre/piano lacquer¹
- H79 Dark textured-grain aluminium trim¹
- 734 High-gloss brown eucalyptus wood¹
- 736 High-gloss black ash wood¹

¹ Optional extra. ² Optional extra, only in conjunction with AMG Sports package and sports seats.

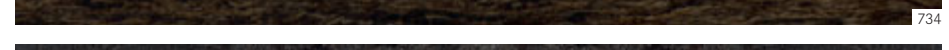
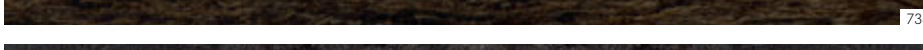
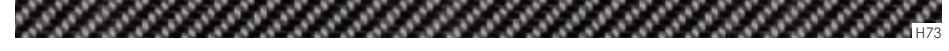
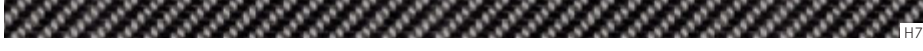
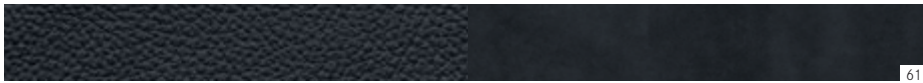
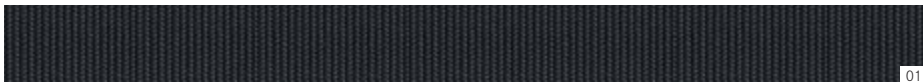



ELEGANCE line.

The optional ELEGANCE design and equipment line emphasises the distinctive side of the E-Class. Exterior features include chrome highlights, the Mercedes star on the bonnet and multi-spoke light-alloy wheels. The interior has a harmonious and comfortable feel courtesy of the exclusive fabric upholstery, refined trim and stylish, dimmable ambient lighting which can be adjusted to three colours.



Exterior

Chrome trip strips on the sides and on the front and rear bumper

DIRECT CONTROL suspension, comfort-tuned

Multi-spoke light-alloy wheels

Radiator grille with 3 chromed louvres, silver-metallic mesh

Interior

Ambient lighting can be set to one of 3 colours, dimmable

High-gloss brown burl walnut wood trim

Illuminated stowage box in centre console and in front of centre armrest

Shift lever trimmed in nappa leather, with insert in high-gloss brown burl walnut wood (in conjunction with manual transmission)

Stowage compartment under the front seats

Strasbourg fabric upholstery, seat design with vertical seamlines





black

- 011 Strasbourg fabric
- 111 ARTICO man-made leather¹
- 211 Leather¹
- 241 Leather²
- 611 ARTICO man-made leather/DINAMICA microfibre²
- 811 Nappa leather¹

crystal grey/seashell grey

- 018 Strasbourg fabric
- 118 ARTICO man-made leather¹
- 218 Leather¹
- 818 Nappa leather¹

crystal grey/black

- 058 Strasbourg fabric
- 158 ARTICO man-made leather¹
- 258 Leather¹
- 858 Nappa leather¹

silk beige/espresso brown

- 115 ARTICO man-made leather¹
- 215 Leather¹
- 815 Nappa leather¹

porcelain/black

- 255 Leather¹
- 855 Nappa leather¹

chestnut brown/black

- 274 Leather¹
- 854 Nappa leather¹

Trim

- H14 High-gloss brown burr walnut wood
 - H09 Open-pore brown ash wood¹
 - H73 AMG carbon fibre/piano lacquer¹
 - H79 Dark textured-grain aluminium trim¹
 - 736 High-gloss black ash wood¹
-

¹ Optional extra. ² Optional extra, only in conjunction with AMG Sports package and sports seats.

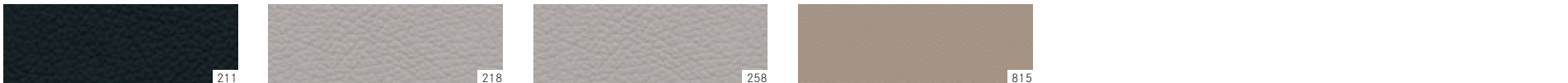
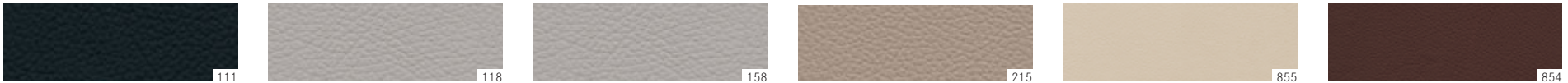
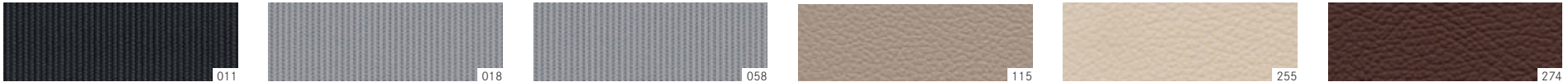



AVANTGARDE line.

The optional AVANTGARDE line lends the E-Class an innovative, sporty character. The exterior has a more striking effect, with the Mercedes star in the radiator grille, rectangular tailpipe trims and the light-alloy wheels. The sportiness continues in the interior: the 3-spoke multifunction steering wheel, for example, is a fitting accompaniment.

Exterior

5-twin-spoke light-alloy wheels

Chrome trim strips on sides and on rear bumper

DIRECT CONTROL suspension, sports tuning and lowered body

Radiator grille with a 2-louvre look and an integral Mercedes star

Twin-pipe exhaust system with rectangular tailpipes in stainless steel integrated in the bumper

Interior

ARTICO man-made leather/Grenoble fabric upholstery, seat design with horizontal seamlines

Dark textured-grain aluminium trim

Dimmable ambient lighting can be set to one of 3 colours

Illuminated stowage box in centre console and in front of centre armrest

Instrument cluster featuring 3 tubes with a sporty design and silver-coloured backplates

Multifunction steering wheel covered in nappa leather, with 12 buttons, in 3-spoke design

Shift lever covered in nappa leather, with chrome trim (in conjunction with manual transmission)





black

411 ARTICO man-made leather/Grenoble fabric

111 ARTICO¹ man-made leather

211 Leather¹

241 Leather³

611 ARTICO man-made leather/DINAMICA microfibre³

811 Nappa leather²

crystal grey/seashell grey

118 ARTICO man-made leather¹

218 Leather¹

818 Nappa leather²

crystal grey/black

158 ARTICO man-made leather¹

258 Leather¹

858 Nappa leather²

silk beige/espresso brown

115 ARTICO man-made leather¹

215 Leather¹

815 Nappa leather²

porcelain/black

255 Leather¹

855 Nappa leather²

chestnut brown/black

274 Leather¹

854 Nappa leather²

Trim

H79 Dark textured-grain aluminium

H14 High-gloss brown burr walnut wood¹

H73 AMG carbon fibre/piano lacquer¹

H09 Open-pore brown ash wood¹

736 High-gloss black ash wood¹

¹ Optional extra.

² Optional extra, not available for AMG models.

³ Optional extra, only in conjunction with AMG Sports package and sports seats.

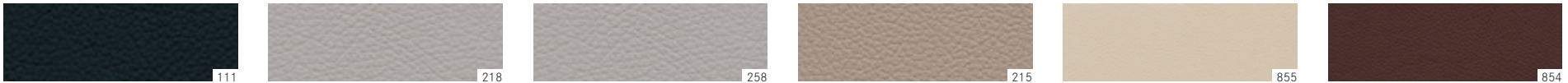
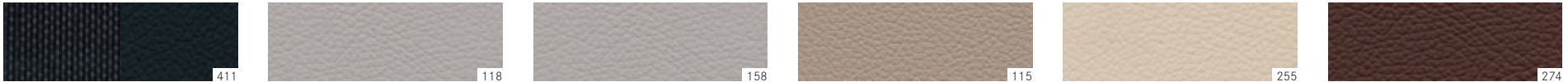



Exclusive package.

The finest materials and elegant visual accents – the optional Exclusive package further enhances the high-quality interior of the ELEGANCE and AVANTGARDE lines, adding to the host of equipment – which is sure to satisfy even very discerning customers.



Interior

Armrests on centre console and doors and door centre panels in nappa leather

Dashboard and beltline with a high-quality cover in ARTICO man-made leather with topstitching

Roof lining, pillars and sun visors in DINAMICA microfibre

Seats with upholstery in nappa leather in black, silk beige or crystal grey

Velour floor mats with nubuck strip in appointments colour



Exterior Sports package.

The optional Exterior Sports package lends the E-Class an even more individual character with a sporty touch. It is above all the DIRECT CONTROL sports suspension and 5-spoke light-alloy wheels which emphasise both the dynamism of the design and a more agile driving feel.



Exterior

5-twin-spoke light-alloy wheels with 245/40 R 18 tyres at the front and 265/35 R 18 tyres at the rear (4MATIC models 245/40 R 18 all round)

DIRECT CONTROL sports suspension (not for 4MATIC models) (Code 486)

Larger, perforated brake discs with "Mercedes-Benz" lettering on the callipers on the front axle

Radiator grille with a 2-louvre look and an integral Mercedes star

Twin-pipe exhaust system with rectangular tailpipes in stainless steel integrated in the bumper



AMG Sports package.

The sporty appearance of the E-Class Saloon and of the E-Class Estate comes to a striking conclusion with the optionally available AMG Sports package – clearly visible and tangible and with special emphasis on the individuality both on the exterior and in the interior.

Exterior

5-twin-spoke AMG light-alloy wheels with 245/40 R 18 tyres at the front and 265/35 R 18 tyres at the rear (4MATIC models have 245/40 R 18 tyres all round)

AMG bodystyling (front/rear apron and side sill panels)

DIRECT CONTROL sports suspension (not for 4MATIC models) (Code 486)

Larger, perforated brake discs with “Mercedes-Benz” lettering on the callipers on the front axle

Radiator grille with a 2-louvre look and an integral Mercedes star

Interior

AMG 3-spoke multifunction sports steering wheel, in black nappa leather, with a flattened bottom section (in conjunction with 7G-TRONIC PLUS)

Brushed stainless-steel sports pedals with rubber studs

DIRECT SELECT steering-wheel gearshift paddles and manual shift mode M (in conjunction with 7G-TRONIC PLUS)

Shift lever covered in nappa leather, with chrome trim (in conjunction with manual transmission)

Sports seats, front, with upholstery in black ARTICO man-made leather/ DINAMICA microfibre with light contrasting topstitching (Code 611)





designo.

Exclusive designo paintwork, exquisite leather upholstery, high-quality trims and roof linings in the finest DINAMICA microfibre are available for the most discerning and highly individualised customer requirements. Further designo appointments and information can be found in the price list or at www.mercedes-benz.com/designo



Exterior

One designo mystic paint finish

Two designo magno paint finishes with matt-finish clearcoat

Two designo metallic paint finishes

Interior

Armrests in the doors plus centre console armrest lid in black designo nappa leather

designo black fabric roof lining

designo DINAMICA microfibre roof lining in 3 colour shades

designo leather appointments in 9 colours

designo leather steering wheel, two-tone

designo wood trim in 3 versions

Door centre panels in designo leather with leather piping in contrasting colour

Specific designo seat upholstery layout with leather piping in a contrasting colour and designo badge in the front seat backrests

Velour floor mats with edging in designo black leather and with metal badge



Standard equipment | Selection.



Roof rails in an aluminium look (Estate only).



Tail lights with LED technology.



Instrument cluster featuring round dials in a tube look.



Heated exterior mirrors left and right, electrically adjustable from inside.



12-button multifunction steering wheel in nappa leather, with 2 chrome inserts.



Front door sill panels in stainless steel.



Audio 20 CD.



DIRECT SELECT lever (in conjunction with 7G-TRONIC PLUS).



Controls on the armrest.



THERMATIC automatic climate control.



NECK-PRO front head restraints.



Single-tone ambient lighting.

Optional extras | Selection.



LED Intelligent Light System¹.



Sliding glass sunroof, electrically operated.



EASY-PACK boot box (for saloon only).



Blind Spot Assist¹ (visual warning).



Electric panoramic sliding glass sunroof.



Trailer coupling, manually folding.

¹ Integral component of Mercedes-Benz Intelligent Drive. More on page 34.



EASY-PACK load-securing kit load compartment management (for Estate only).



Memory package.



KEYLESS-GO package with HANDS-FREE ACCESS.



Fire extinguisher, mounted at the front of the driver's seat.



Wood/leather steering wheel.



Controls for climatized front seats.

Wheels.



9-spoke light-alloy wheels (standard) with 205/60 R 16 tyres (not for Estate) or 225/55 R 16 tyres (depending on engine for 4- and 6-cylinder models, Code R12/R13).



5-twin-spoke light-alloy wheels with 245/45 R 17 tyres (standard for AVANTGARDE for 4- and 6-cylinder models, Code 44R/R38²).



10-spoke light-alloy wheels with 225/55 R 16 tyres, himalayas grey (option for 4- and 6-cylinder models without 4MATIC, depending on the engine without extra charge, Code 55R).



5-spoke light-alloy wheels with 245/40 R 18 tyres at the front and 265/35 R 18 tyres at the rear (option, Code R08/52R).



Multi-spoke light-alloy wheels with 245/45 R 17 tyres (standard on ELEGANCE for 4- and 6-cylinder versions and for all 4MATIC models except E 500 4MATIC, Code 08R/04R¹).



7-spoke light-alloy wheels with 205/60 R 16 tyres (option for E 200 CDI, E 220 CDI and E 200, not for Estate, Code 34R).



5-spoke light-alloy wheels with 245/45 R 17 (option for 4- and 6-cylinder models, Code 02R).



5-twin-spoke light-alloy wheels with 245/40 R 18 tyres at the front and 265/35 R 18 at the rear, in the case of 4MATIC 245/40 R 18 all round (part of the Exterior Sports package, Code 22R/66R).



5-twin-spoke light-alloy wheels with 245/35 R 19 tyres at the front and 275/30 R 19 tyres at the rear (option, Code R17).



5-twin-spoke AMG light-alloy wheels with 245/40 R 18 tyres at the front and 265/35 R 18 tyres at the rear, 4MATIC with 245/40 R 18 tyres all round (option, Code 795/791).



10-spoke AMG light-alloy wheels with 255/35 R 19 tyres at the front and 285/30 R 19 tyres at the rear, painted titanium grey matt, rim flange with high-sheen finish (standard only for E 63 AMG S-Model 4MATIC, Code 662).



10-spoke AMG light-alloy wheels with 255/35 R 19 tyres at the front and 285/30 R 19 tyres at the rear, painted matt black, rim flange with high-sheen finish (option for AMG models, Code 752).



5-twin-spoke AMG light-alloy wheels with 245/40 R 18 tyres at the front and 265/35 R 18 tyres at the rear, 4MATIC with 245/40 R 18 tyres all round (part of AMG Sports package, Code 660/794).



10-spoke AMG light-alloy wheels with 255/35 R 19 tyres at the front and 285/30 R 19 tyres at the rear, with high-sheen finish (Code 797³/796⁴).



7-twin-spoke AMG light-alloy wheels with 245/35 R 19 tyres at the front and 275/30 R 19 tyres at the rear (option, Code 770).



5-twin-spoke AMG forged wheels with 255/35 R 19 tyres at the front and 285/30 R 19 tyres at the rear, painted titanium grey with high-sheen finish (option for AMG models, Code 785).

¹ Light-alloy wheels with identical design to Code 08R, but with 245/40 R 18 tyres, Code 04R (standard for E 500 and E 500 4MATIC). ² Light-alloy wheels with identical design to Code 44R, but with 245/40 R 18 tyres, Code R38. ³ AMG light-alloy wheels with identical design to Code 797, but with 255/40 R 18 tyres at the front and 285/35 R 18 tyres at the rear, Code 796. Standard for E 63 AMG, not for Estate. ⁴ Standard for E 63 AMG 4MATIC, optional for E 63 AMG (Saloon), no-cost option for E 63 AMG S-Model 4MATIC.

Genuine accessories.

The Mercedes-Benz genuine accessories offer you everything you need to make optimum use of all the opportunities at your disposal where the E-Class Saloon and Estate are concerned. Whether it's the exterior, interior or telematics – all the products are optimally matched to the vehicles. → www.mercedes-benz-accessories.com



The best in entertainment for the rear passengers (also available as an optional extra ex factory).

Rear Seat Entertainment System. With the Rear Seat Entertainment System, your enjoyment doesn't have to take a back seat. For the elegant DVD system allows favourite films, images and even video games¹ to be shown on two brilliant 17.8 cm LCD colour screens. The rear passengers can view a film together or each watch their own choice of content thanks to separate DVD players. In addition to this, further storage media can be used via the USB interface or the SD card slot. The Rear Seat Entertainment System requires no factory pre-installations whatsoever and can be integrated easily.

¹ External devices such as games consoles can be connected.

Light-alloy wheels. The flamboyant design of the light-alloy wheels from the Mercedes-Benz accessories range underlines the dynamic presence of the E-Class. The light-alloy wheels come in a range of different sizes and designs, such as 10-twin-spoke wheels painted in tremolite with a high-shine finish paired with 245/40 R 18 tyres.



10-twin-spoke light-alloy wheels with 245/40 R 18 tyres.²

Child seat. The KidFix child seat also offers the younger passengers a high degree of safety and is thus ideal for children aged between around 3½ and 12 years (15 to 36 kg). The raised seat and height-adjustable backrest ensure optimum side impact protection.



Comfort and safety for the younger passengers.

Basic carrier bars. With the “Alustyle” basic carrier bars you can transport sports equipment and pieces of luggage flexibly. The basic carrier bars can be combined with various roof attachments, for example with the Mercedes-Benz roof boxes. These are available in the sizes 330 and 450 litres. The “New Alustyle Comfort” ski and snowboard rack can transport up to six pairs of skis or four snowboards.



Tailor-made transport solution thanks to innovative technology (also available as an optional extra ex factory).

² Genuine-accessory wheels are supplied without tyres, wheel hub covers and wheel bolts; availability depends on engine variant and selected equipment; further details can be obtained from your authorised Mercedes-Benz dealer.

Services.

Mercedes-Benz Financial Services. Our sophisticated leasing and financing products are tailored to your individual financial needs, giving you the opportunity to drive your dream car while staying financially flexible. Once you have chosen a model, you can enjoy the peace of mind of knowing that both the vehicle itself and our insurance products will keep you particularly well protected. What's more, our range of service products is designed to ensure that your car stays in top shape while offering transparent, manageable conditions. For further details, speak to your Mercedes-Benz dealer, who will be glad to go through the latest financial services and terms and conditions with you.

Test drive. The unique feeling of driving a Mercedes cannot be put into words. We'd like to invite you to experience it for yourself – take a test drive and find out first hand how it feels to drive your dream car. Your nearest authorised Mercedes-Benz dealer is looking forward to your call.

Mercedes-Benz mobility. Your new car comes complete with the promise of feeling safe on the road, but if you should ever need assistance, then Mercedes-Benz Service24h is there to help. Just call the freephone service hotline on 00800 1 777 7777¹. The newly integrated telematics service, Mercedes-Benz Contact², is even more customer friendly: a touch of a button is all it takes to contact the Mercedes-Benz customer centre. If you wish, the relevant vehicle- and position-related data can be transmitted at the same time, thereby allowing the centre to react quickly and provide rapid on-the-spot assistance. Also standard with your new car at no extra charge is the Mercedes-Benz Mobilo³ mobility package. Whether you have lost your key, had a breakdown which cannot be repaired immediately or suffered damage to the vehicle due to an accident or vandalism, Mobilo is there to help you reach your destination – anywhere in Europe.

Mercedes-Benz Museum. Discover what has been moving the world for over 125 years, and embark on a fascinating journey through automotive history in the Mercedes-Benz Museum. More than 1500 exhibits covering an area of 16,500 square metres chart the unique heritage and innovative flair of the inventor of the motor car. You will find one automotive legend after another awaiting you: unique exhibits such as the oldest Mercedes still in existence from 1902, supercharged cars or the awe-inspiring gull-wings. The museum is a spectacular sight in its own right too, thanks to an architecture that breaks away from traditional concepts and creates an unprecedented sense of space. Welcome to the Mercedes-Benz Museum – a world of innovation. www.mercedes-benz-classic.com/museum.



¹ Alternative: +49 69 95 30 72 77. ² Requires a factory-fitted radio, connected to an operational mobile phone. The only charge incurred is the cost of the mobile phone call to the landline network. ³ Once the mobility guarantee has expired (four years), Mobilo can be extended to provide cover in the event of breakdown and insurance claims one year at a time for a maximum of 30 years, provided that regular maintenance is carried out by your Mercedes-Benz service partner.

Interactive Owner's Manual, Mercedes-Benz Guides and Digital Owner's Manual. The website also offers an interactive tour, enabling you to acquaint yourself with your dream car. You can view key functions in detail, gain an insight into the car's inner workings or look at the benefits of each model. For further details, go to your national website. The "Mercedes-Benz Guides" app lets you explore the highlights of the individual models both online and offline. The app is available free of charge from the Apple® iTunes® Store (iOS) as well as the Google Play store (Android). Using the Digital Owner's Manual, information can also be conveniently called up in the vehicle itself via the central display (depending on the model series).

Mobile internet. The entire world of Mercedes-Benz can be accessed at any time with your web-capable mobile device – including specially adapted content for both smartphones and tablets. As well as an overview of all the passenger car models, there are insights into the entire brand world along with a wealth of entertainment offers and direct links to our range of services at www.mercedes-benz.com

Mercedes-Benz ServiceContracts. You need never worry about unexpected workshop costs⁴ again: depending on the specific contract, a Mercedes-Benz ServiceContract can cover unforeseen repairs, maintenance or wear parts. As a result, your vehicle stays in great condition – thanks to the Mercedes-Benz quality you can expect from our highly qualified workshop specialists and Mercedes-Benz genuine parts. Your Mercedes-Benz dealer will be pleased to tell you more about the available service contracts and terms and conditions.

Accident repairs. Should the worst happen and you find yourself in need of repairs, with Mercedes-Benz accident repairs you will receive the right assistance for your

vehicle and ensure that its high-quality safety features are properly maintained. Whether you need paint, body or glass repair work carried out, the highly trained specialists at your Mercedes-Benz service partner will repair your Mercedes-Benz and get you quickly back on the road again. Further information is available from your authorised Mercedes-Benz dealer.



⁴ In accordance with the terms and conditions of the Mercedes-Benz ServiceContracts.

Technical data for the Saloon.

	Diesel engines							
	E 200 CDI	E 220 CDI	E 220 BlueTEC	E 220 BlueTEC BE ⁶ Edition	E 250 CDI	E 250 CDI 4MATIC	E 300 BlueTEC HYBRID	E 300 BlueTEC
No. of cylinders/arrangement	4/in-line	4/in-line	4/in-line	4/in-line	4/in-line	4/in-line	4/in-line	6/V
Total displacement in cc	2143	2143	2143	2143	2143	2143	2143	2987
Rated output ¹ in kW (hp) at rpm	100 (136)/2800-4600 [100 (136)/2800-4600]	125 (170)/3000-4200 [125 (170)/3000-4200]	- [125 (170)/3000-4200]	- [125 (170)/3000-4200]	150 (204)/3800 [150 (204)/3800]	- [150 (204)/3800]	- [150 (204)/4200*]	- [170(231)/3800]
Rated torque ¹ in Nm at rpm	360/1600-2600 [360/1600-2600]	400/1400-2800 [400/1400-2800]	- [400/1400-2800]	- [400/1400-2800]	500/1600-1800 [500/1600-1800]	- [500/1600-1800]	- [500/1600-1800]	- [540/1550-2400]
Acceleration from 0 to 100 km/h in s	10.2 [9.5]	8.7 [8.4]	- [8.4]	- [8.4]	7.7 [7.5]	- [7.9]	- [7.5]	- [7.1]
Top speed approx. in km/h	210 [207]	228 [227]	- [227]	- [227]	240 [242]	- [238]	- [242]	- [250 ²]
Tyre size, front	205/60 R 16	205/60 R 16	205/60 R 16	205/60 R 16	205/60 R 16	245/45 R 17	225/55 R 16	225/55 R 16
Tyre size, rear	205/60 R 16	205/60 R 16	205/60 R 16	205/60 R 16	205/60 R 16	245/40 R 17	225/55 R 16	225/55 R 16
Fuel	Diesel fuel	Diesel fuel	Diesel fuel	Diesel fuel	Diesel fuel	Diesel fuel	Diesel fuel	Diesel fuel
Fuel consumption ³ (l/100 km)								
Urban	6.0-5.8 [6.1-6.0]	6.1-5.8 [6.1-5.6]	- [5.6-5.5]	- [5.6-5.4]	6.2-5.9 [6.2-5.7]	- [6.6-6.4]	- [4.2-4.1]	- [7.2-6.9]
Extra-urban	4.5-4.2 [4.6-4.2]	4.3-4.1 [4.4-4.1]	- [4.1-3.9]	- [4.1-3.7]	4.4-4.2 [4.5-4.2]	- [5.0-4.6]	- [4.2-4.1]	- [5.1-4.7]
Combined	5.1-4.8 [5.2-4.9]	5.0-4.7 [5.0-4.6]	- [4.6-4.5]	- [4.6-4.4]	5.1-4.8 [5.1-4.7]	- [5.7-5.4]	- [4.2-4.1]	- [5.9-5.5]
CO ₂ emissions ³ (g/km) combined	134-125 [135-127]	129-123 [131-123]	- [122-117]	- [122-114]	132-126 [134-126]	- [149-140]	- [110-107]	- [154-144]
Emissions class ⁴	Euro 5	Euro 5	Euro 6	Euro 6	Euro 5	Euro 5	Euro 5	Euro 6
Efficiency class	A [A]	A [A]	- [A+]	- [A+]	A [A]	- [A]	- [A+]	- [A]
Tank capacity, incl. reserve, approx. in l	59/8.0	59/8.0	59/8.0	59/8.0	59/8.0	59/8.0	59/8.0	59/8.0
Load capacity in l	540	540	490	540	540	540	505	490
Turning circle diameter in m	11.28	11.28	11.28	11.28	11.28	11.28	11.28	11.28
Kerb weight ⁵ in kg	1735 [1735]	1735 [1735]	- [1795]	- [1795]	1765 [1775]	- [1845]	- [1845]	- [1885]
Payload in kg	565 [565]	565 [565]	- [565]	- [475]	565 [555]	- [565]	- [585]	- [555]
Perm. GVW in kg	2300 [2300]	2300 [2300]	- [2360]	- [2270]	2330 [2330]	- [2410]	- [2430]	- [2440]

¹ Electric motor 20 kW. ² Figures in accordance with Directive 80/1269/EEC in the currently applicable version. ³ Electronically governed. ⁴ The figures shown were obtained in accordance with the prescribed measuring process (Directive (EC) 715/2007 in the currently applicable version in each case). The figures are not based on an individual model and do not constitute part of the product offer; they are provided solely for purposes of comparison between the different vehicle models. ⁵ Information only valid within the European Union.

Technical data for the Saloon.

	Diesel engines		Petrol engines						
	E 350 BlueTEC	E 350 BlueTEC 4MATIC	E 200	E 200 Natural Gas Drive	E 250	E 300	E 300 4MATIC	E 350	E 350 4MATIC
No. of cylinders/arrangement	6/V	6/V	4/in-line	4/in-line	4/in-line	6/V	6/V	6/V	6/V
Total displacement in cc	2987	2987	1991	1991	1991	3498	3498	3498	3498
Rated output ¹ in kW (hp) at rpm	- [185 (252)/3600]	- [185 (252)/3600]	135 (184)/5500 [135 (184)/5500]	- [115 (156)/5000]	- [155 (211)/5500]	- [185 (252)/6500]	- [185 (252)/6500]	- [225 (306)/6500]	- [225 (306)/6500]
Rated torque ¹ in Nm at rpm	- [620/1600-2400]	- [620/1600-2400]	270/1200-4000 [300/1200-4000]	- [270/1250]	- [350/1200-4000]	- [340/3500-4500]	- [340/3500-4500]	- [370/3500-5250]	- [370/3500-5250]
Acceleration from 0 to 100 km/h in s	- [6.6]	- [6.7]	8.2 [7.9]	- [10.4]	- [7.4]	- [7.1]	- [7.4]	- [6.3]	- [6.6]
Top speed approx. in km/h	- [250 ²]	- [245]	233 [233]	- [220]	- [243]	- [250 ²]	- [245]	- [250 ²]	- [250 ²]
Tyre size, front	225/55 R 16	245/45 R 17	205/60 R 16	225/55 R 16	225/55 R 16	225/55 R 16	245/45 R 17	225/55 R 16	245/45 R 17
Tyre size, rear	225/55 R 16	245/45 R 17	205/60 R 16	225/55 R 16	225/55 R 16	225/55 R 16	245/45 R 17	225/55 R 16	245/45 R 17
Fuel	Diesel fuel	Diesel fuel	Premium petrol	Premium petrol/natural gas	Premium petrol	Premium petrol	Premium petrol	Premium petrol	Premium petrol
Fuel consumption ³ (l/100 km)									
Urban	- [6.7-6.4]	- [7.7-7.3]	8.4-8.0 [7.7-7.5]	- [8.5-8.3/5.8-5.8 ^{7,8}]	- [7.7-7.5]	- [9.5-9.5]	- [9.9-9.9]	- [9.5-9.5]	- [9.9-9.9]
Extra-urban	- [5.1-4.7]	- [5.5-5.1]	5.3-5.0 [5.1-4.8]	- [5.4-5.2/3.6-3.3 ^{7,8}]	- [5.1-4.8]	- [5.6-5.3]	- [6.0-5.9]	- [5.6-5.3]	- [6.0-5.9]
Combined	- [5.6-5.3]	- [6.4-5.9]	6.5-6.1 [6.1-5.8]	- [6.6-6.3/4.4-4.3 ^{7,8}]	- [6.1-5.8]	- [7.0-6.8]	- [7.5-7.4]	- [7.0-6.8]	- [7.5-7.4]
CO ₂ emissions ³ (g/km) combined	- [148-138]	- [169-159]	151-142 [142-135]	- [153-147/120-116 ⁷]	- [142-135]	- [164-159]	- [176-174]	- [164-159]	- [176-174]
Emissions class ⁴	Euro 6	Euro 6	Euro 6	Euro 6	Euro 6	Euro 5	Euro 5	Euro 5	Euro 5
Efficiency class	- [A]	- [B]	B [B]	- [B/A+ ⁷]	- [A]	- [C]	- [C]	- [C]	- [C]
Tank capacity, incl. reserve, approx. in l	59/8.0	59/8.0	59/8.0	59/8.0/20.0 ⁷ /2.0 ⁷	59/8.0	59/8.0	59/8.0	59/8.0	59/8.0
Load capacity in l	490	490	540	400	540	540	540	540	540
Turning circle diameter in m	11.28	11.28	11.28	11.28	11.28	11.28	11.28	11.28	11.28
Kerb weight ⁵ in kg	- [1885]	- [1955]	1615 [1655]	- [1795]	- [1680]	- [1735]	- [1825]	- [1735]	- [1825]
Payload in kg	- [555]	- [545]	565 [555]	- [505]	- [565]	- [565]	- [565]	- [565]	- [565]
Perm. GVW in kg	- [2440]	- [2500]	2180 [2210]	- [2300]	- [2245]	- [2300]	- [2390]	- [2300]	- [2390]

¹ Figures according to Directive 92/21/EC, version 95/48/EC (kerb weight with fuel tank 90% full, driver, 68 kg, and luggage, 7 kg) for standard-specification vehicles. Optional extras and accessories will generally increase this figure and reduce the payload capacity accordingly.

² BlueEFFICIENCY. ³ In natural-gas mode. ⁴ kg/100 km. Figures in square brackets refer to models with automatic transmission. Further technical data can be found at www.mercedes-benz.com

Technical data for the Saloon.

	Petrol engines						
	E 400	E 400 4MATIC	E 500	E 500 4MATIC	E 63 AMG	E 63 AMG 4MATIC	E 63 AMG S-Model 4MATIC
No. of cylinders/arrangement	6/V	6/V	8/V	8/V	8/V	8/V	8/V
Total displacement in cc	2996	2996	4663	4663	5461	5461	5461
Rated output ¹ in kW (hp) at rpm	- [245 (333)/5250-6000]	- [245 (333)/5250-6000]	- [300 (408)/5000-5750]	- [300 (408)/5000-5750]	- [410 (557)/5500]	- [410 (557)/5500]	- [430 (585)/5500]
Rated torque ¹ in Nm at rpm	- [480/1600-4000]	- [480/1600-4000]	- [600/1600-4750]	- [600/1600-4750]	- [720/1750-5250]	- [720/1750-5250]	- [800/1750-5000]
Acceleration from 0 to 100 km/h in s	- [5.3]	- [5.3]	- [4.9]	- [4.8]	- [4.2]	- [3.7]	- [3.6]
Top speed approx. in km/h	- [250 ²]	- [250 ²]	- [250 ²]	- [250 ²]	- [250 ²]	- [250 ²]	- [250 ²]
Tyre size, front	245/45 R 17	245/45 R 17	245/40 R 18	245/40 R 18	255/40 ZR 18 XL	255/35 ZR 19 XL	255/35 ZR 19 XL
Tyre size, rear	245/45 R 17	245/45 R 17	245/40 R 18	245/40 R 18	285/35 ZR 18 XL	285/30 ZR 19 XL	285/30 ZR 19 XL
Fuel	Premium petrol	Premium petrol	Premium petrol	Premium petrol	Super Plus petrol	Super Plus petrol	Super Plus petrol
Fuel consumption ³ (l/100 km)							
Urban	- [10.8-10.4]	- [11.6-11.2]	- [12.6-12.6]	- [13.0-13.0]	- [13.8-13.8]	- [14.4-14.4]	- [14.4-14.4]
Extra-urban	- [6.2-5.8]	- [6.8-6.4]	- [6.7-6.7]	- [7.2-7.2]	- [7.5-7.5]	- [7.9-7.9]	- [7.9-7.9]
Combined	- [7.9-7.5]	- [8.5-8.1]	- [8.9-8.9]	- [9.4-9.4]	- [9.8-9.8]	- [10.3-10.3]	- [10.3-10.3]
CO ₂ emissions ³ (g/km) combined	- [185-175]	- [199-189]	- [209-209]	- [219-219]	- [230-230]	- [242-242]	- [242-242]
Emissions class ⁴	Euro 6	Euro 6	Euro 5	Euro 5	Euro 6	Euro 6	Euro 6
Efficiency class	- [C]	- [D]	- [E]	- [E]	- [F]	- [F]	- [F]
Tank capacity, incl. reserve, approx. in l	59/8.0	59/8.0	80/9.0	80/9.0	66/14	66/14	66/14
Load capacity in l	540	540	540	540	540	540	540
Turning circle diameter in m	11.28	11.28	11.28	11.28	11.35	11.75	11.75
Kerb weight ⁵ in kg	- [1785]	- [1845]	- [1925]	- [1985]	- [1845]	- [1920]	- [1940]
Payload in kg	- [565]	- [565]	- [555]	- [535]	- [545]	- [505]	- [485]
Perm. GVW in kg	- [2350]	- [2410]	- [2480]	- [2520]	- [2390]	- [2425]	- [2425]

^{*} Electric motor 20 kW. ¹ Figures in accordance with Directive 80/1269/EEC in the currently applicable version. ² Electronically governed. ³ The figures shown were obtained in accordance with the prescribed measuring process (Directive (EC) 715/2007 in the currently applicable version in each case). The figures are not based on an individual model and do not constitute part of the product offer; they are provided solely for purposes of comparison between the different vehicle models. ⁴ Information only valid within the European Union.

Technical data for the Estate.

	Diesel engines					
	E 200 CDI	E 220 CDI	E 250 CDI	E 250 CDI 4MATIC	E 300 BlueTEC HYBRID	E 300 BlueTEC
No. of cylinders/arrangement	4/in-line	4/in-line	4/in-line	4/in-line	4/in-line	6/V
Total displacement in cc	2143	2143	2143	2143	2143	2987
Rated output ¹ in kW (hp) at rpm	100 (136)/2800-4600 [100 (136)/2800-4600]	125 (170)/3000-4200 [125 (170)/3000-4200]	150 (204)/3800 [150 (204)/3800]	- [150 (204)/3800]	- [150 (204)/4200*]	- [170 (231)/3800]
Rated torque ¹ in Nm at rpm	360/1600-2600 [360/1600-2600]	400/1400-2800 [400/1400-2800]	500/1600-1800 [500/1600-1800]	- [500/1600-1800]	- [500/1600-1800]	- [540/1550-2400]
Acceleration from 0 to 100 km/h in s	10.9 [10.1]	8.8 [8.6]	7.8 [7.8]	- [8.1]	- [7.8]	- [7.4]
Top speed approx. in km/h	205 [203]	220 [216]	232 [232]	- [230]	- [232]	- [240]
Tyre size, front	225/55 R 16	225/55 R 16	225/55 R 16	245/45 R 17	225/55 R 16	225/55 R 16
Tyre size, rear	225/55 R 16	225/55 R 16	225/55 R 16	245/45 R 17	225/55 R 16	225/55 R 16
Fuel	Diesel fuel	Diesel fuel	Diesel fuel	Diesel fuel	Diesel fuel	Diesel fuel
Fuel consumption ³ (l/100 km)						
Urban	6.4-6.2 [6.5-6.4]	6.1-6.0 [6.4-6.2]	6.1-6.0 [6.5-6.3]	- [6.7-6.6]	- [4.5-4.5]	- [7.2-7.0]
Extra-urban	4.8-4.5 [4.8-4.6]	4.6-4.4 [4.8-4.5]	4.7-4.5 [4.9-4.6]	- [5.2-5.0]	- [4.6-4.4]	- [5.3-5.0]
Combined	5.4-5.2 [5.4-5.3]	5.2-5.0 [5.4-5.2]	5.3-5.1 [5.5-5.3]	- [5.9-5.7]	- [4.5-4.4]	- [6.1-5.7]
CO ₂ emissions ³ (g/km) combined	141-135 [141-137]	135-132 [141-133]	138-134 [145-135]	- [155-150]	- [119-116]	- [159-150]
Emissions class ⁴	Euro 5	Euro 5	Euro 5	Euro 5	Euro 5	Euro 6
Efficiency class	A [A]	A [A]	A [A]	- [A]	- [A+]	- [A]
Tank capacity, incl. reserve, approx. in l	59/8.0	59/8.0	59/8.0	59/8.0	59/8.0	59/8.0
Load capacity in l	695-1950	695-1950	695-1950	695-1950	650-1905	600-1855
Turning circle diameter in m	11.28	11.28	11.28	11.28	11.28	11.28
Kerb weight ⁵ in kg	1845 [1845]	1845 [1845]	1885 [1885]	- [1955]	- [1955]	- [1955]
Payload in kg	595 [595]	595 [595]	595 [595]	- [595]	- [595]	- [595]
Perm. GVW in kg	2440 [2440]	2440 [2440]	2480 [2480]	- [2550]	- [2550]	- [2550]

¹ Figures according to Directive 92/21/EC, version 95/48/EC (kerb weight with fuel tank 90% full, driver, 68 kg, and luggage, 7 kg) for standard-specification vehicles. Optional extras and accessories will generally increase this figure and reduce the payload capacity accordingly. Figures in square brackets refer to models with automatic transmission. Further technical data can be found at www.mercedes-benz.com

Technical data for the Estate.

	Diesel engines		Petrol engines				
	E 350 BlueTEC	E 350 BlueTEC 4MATIC	E 200	E 250	E 300	E 300 4MATIC	E 350
No. of cylinders/arrangement	6/V	6/V	4/in-line	4/in-line	6/V	6/V	6/V
Total displacement in cc	2987	2987	1991	1991	3498	3498	3498
Rated output ¹ in kW (hp) at rpm	- [185 (252)/3600]	- [185 (252)/3600]	135 (184)/5500 [135 (184)/5500]	- [155 (211)/5500]	- [185 (252)/6500]	- [185 (252)/6500]	- [225 (306)/6500]
Rated torque ¹ in Nm at rpm	- [620/1600-2400]	- [620/1600-2400]	270/1200-4000 [300/1200-4000]	- [350/1200-4000]	- [340/3500-4500]	- [340/3500-4500]	- [370/3500-5250]
Acceleration from 0 to 100 km/h in s	- [6.9]	- [7.0]	8.5 [8.3]	- [7.8]	- [7.5]	- [7.8]	- [6.7]
Top speed approx. in km/h	- [250 ²]	- [240]	226 [225]	- [233]	- [250 ²]	- [243]	- [250 ²]
Tyre size, front	225/55 R 16	245/45 R 17	225/55 R 16	225/55 R 16	225/55 R 16	245/45 R 17	225/55 R 16
Tyre size, rear	225/55 R 16	245/45 R 17	225/55 R 16	225/55 R 16	225/55 R 16	245/45 R 17	225/55 R 16
Fuel	Diesel fuel	Diesel fuel	Premium petrol	Premium petrol	Premium petrol	Premium petrol	Premium petrol
Fuel consumption ³ (l/100 km)							
Urban	- [6.8-6.6]	- [7.9-7.7]	8.6-8.4 [7.8-7.5]	- [7.9-7.6]	- [9.7-9.6]	- [10.3-10.3]	- [9.7-9.6]
Extra-urban	- [5.1-4.9]	- [5.7-5.4]	5.6-5.2 [5.3-5.0]	- [5.4-5.1]	- [5.8-5.6]	- [6.6-6.4]	- [5.8-5.6]
Combined	- [5.7-5.5]	- [6.5-6.4]	6.7-6.4 [6.2-6.0]	- [6.3-6.1]	- [7.2-7.1]	- [7.9-7.8]	- [7.2-7.1]
CO ₂ emissions ³ (g/km) combined	- [150-144]	- [173-170]	157-149 [145-139]	- [147-141]	- [169-165]	- [186-184]	- [169-165]
Emissions class ⁴	Euro 6	Euro 6	Euro 6	Euro 6	Euro 5	Euro 5	Euro 5
Efficiency class	- [A]	- [B]	B [B]	- [A]	- [C]	- [C]	- [C]
Tank capacity, incl. reserve, approx. in l	59/8.0	59/8.0	59/8.0	59/8.0	59/8.0	59/8.0	59/8.0
Load capacity in l	600-1855	600-1855	695-1950	695-1950	695-1950	695-1950	695-1950
Turning circle diameter in m	11.28	11.28	11.28	11.28	11.28	11.28	11.28
Kerb weight ⁵ in kg	- [1955]	- [2035]	1735 [1735]	- [1785]	- [1845]	- [1925]	- [1845]
Payload in kg	- [595]	- [595]	595 [595]	- [595]	- [595]	- [595]	- [595]
Perm. GVW in kg	- [2550]	- [2630]	2330 [2330]	- [2380]	- [2440]	- [2520]	- [2440]

¹ Figures in accordance with Directive 80/1269/EEC in the currently applicable version. ² Electronically governed. ³ The figures shown were obtained in accordance with the prescribed measuring process (Directive (EC) 715/2007 in the currently applicable version in each case). The figures are not based on an individual model and do not constitute part of the product offer; they are provided solely for purposes of comparison between the different vehicle models. ⁴ Information only valid within the European Union.

Technical data for the Estate.

	Petrol engines						
	E 350 4MATIC	E 400	E 400 4MATIC	E 500	E 500 4MATIC	E 63 AMG 4MATIC	E 63 AMG S-Model 4MATIC
No. of cylinders/arrangement	6/V	6/V	6/V	8/V	8/V	8/V	8/V
Total displacement in cc	3498	2996	2996	4663	4663	5461	5461
Rated output ¹ in kW (hp) at rpm	- [225 (306)/6500]	- [245 (333)/5250-6000]	- [245 (333)/5250-6000]	- [300 (408)/5000-5750]	- [300 (408)/5000-5750]	- [410 (557)/5500]	- [430 (585)/5500]
Rated torque ¹ in Nm at rpm	- [370/3500-5250]	- [480/1600-4000]	- [480/1600-4000]	- [600/1600-4750]	- [600/1600-4750]	- [720/1750-5250]	- [800/1750-5000]
Acceleration from 0 to 100 km/h in s	- [7.1]	- [5.4]	- [5.4]	- [5.0]	- [4.9]	- [3.8]	- [3.7]
Top speed approx. in km/h	- [250 ²]	- [250 ²]	- [250 ²]	- [250 ²]	- [250 ²]	- [250 ²]	- [250 ²]
Tyre size, front	245/45 R 17	245/45 R 17	245/45 R 17	245/40 R 18	245/40 R 18	255/35 ZR 19 XL	255/35 ZR 19 XL
Tyre size, rear	245/45 R 17	245/45 R 17	245/45 R 17	245/40 R 18	245/40 R 18	285/30 ZR 19 XL	285/30 ZR 19 XL
Fuel	Premium petrol	Premium petrol	Premium petrol	Premium petrol	Premium petrol	Super Plus petrol	Super Plus petrol
Fuel consumption ³ (l/100 km)							
Urban	- [10.3-10.3]	- [11.0-10.7]	- [11.7-11.5]	- [12.9-12.9]	- [13.1-13.1]	- [14.4-14.4]	- [14.4-14.4]
Extra-urban	- [6.6-6.4]	- [6.2-6.1]	- [7.1-6.8]	- [7.1-7.1]	- [7.4-7.4]	- [8.2-8.2]	- [8.2-8.2]
Combined	- [7.9-7.8]	- [7.9-7.9]	- [8.8-8.5]	- [9.3-9.3]	- [9.5-9.5]	- [10.5-10.5]	- [10.5-10.5]
CO ₂ emissions ³ (g/km) combined	- [186-184]	- [184-183]	- [205-197]	- [216-216]	- [222-222]	- [246-246]	- [246-246]
Emissions class ⁴	Euro 5	Euro 6	Euro 6	Euro 5	Euro 5	Euro 6	Euro 6
Efficiency class	- [C]	- [C]	- [D]	- [E]	- [E]	- [F]	- [F]
Tank capacity, incl. reserve, approx. in l	59/8.0	59/8.0	59/8.0	80/9.0	80/9.0	66/14	66/14
Load capacity in l	695-1950	695-1950	695-1950	695-1950	695-1950	695-1950	695-1950
Turning circle diameter in m	11.28	11.28	11.28	11.28	11.28	11.75	11.75
Kerb weight ⁵ in kg	- [1925]	- [1885]	- [1935]	- [1985]	- [2075]	- [2025]	- [2045]
Payload in kg	- [595]	- [595]	- [595]	- [595]	- [595]	- [555]	- [535]
Perm. GVW in kg	- [2520]	- [2480]	- [2530]	- [2580]	- [2670]	- [2580]	- [2580]

¹ Figures according to Directive 92/21/EC, version 95/48/EC (kerb weight with fuel tank 90% full, driver, 68 kg, and luggage, 7 kg) for standard-specification vehicles. Optional extras and accessories will generally increase this figure and reduce the payload capacity accordingly. Figures in square brackets refer to models with automatic transmission. Further technical data can be found at www.mercedes-benz.com

Dimensions for the Saloon.

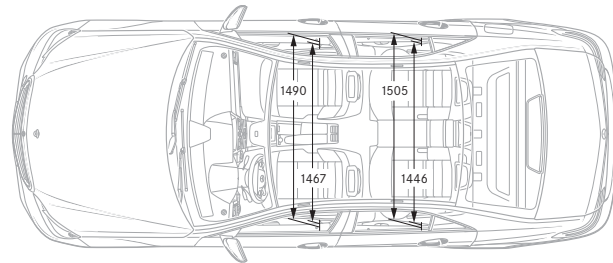
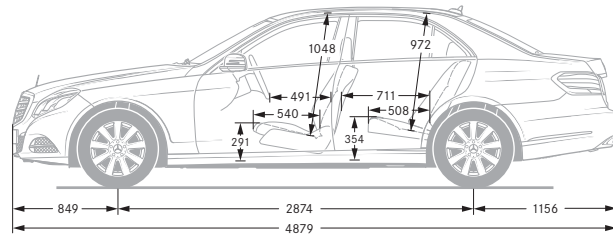
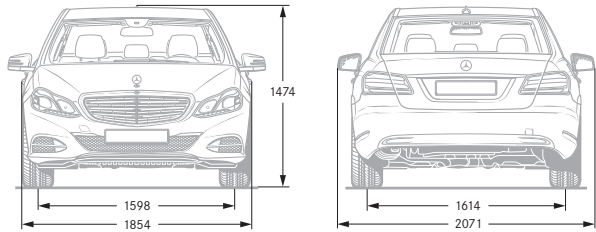

Dimensions for the Estate.

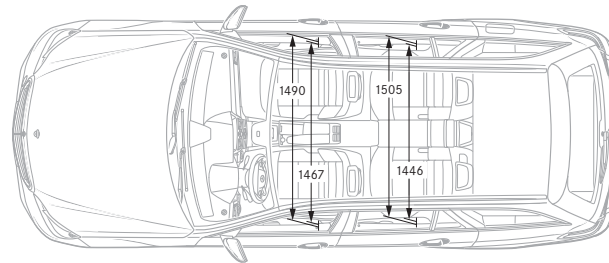
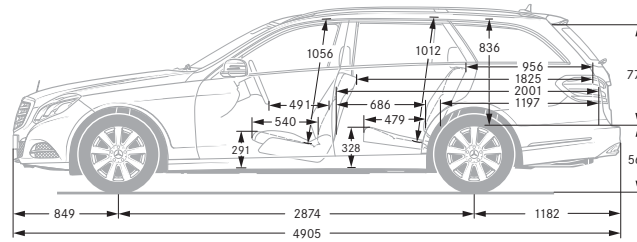
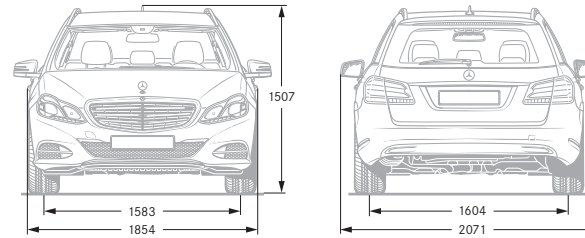

Paintwork.

The paint system developed by Mercedes-Benz includes one of the best clearcoats on the automotive market and is a key factor behind the car's excellent value retention. The secret lies in the exceptionally dense molecular structure, which makes both the metallic and the non-metallic clearcoats more resistant and produces a longer-lasting and visibly more intensive shine.

Non-metallic paints

- 040 black
- 149 polar white

Metallic paints¹

- 197 obsidian black
- 526 dolomite brown
- 755 tenorite grey
- 775 iridium silver
- 792 palladium silver
- 890 cavansite blue
- 988 diamond silver

Special paints¹

- 033 designo mocha black
- 041 designo graphite
- 044 designo magno alanite grey
- 049 designo magno cashmere white
- 052 designo mystic brown
- 585 covelline blue
- 799 diamond white metallic BRIGHT
- 996 hyacinth red

All measurements in millimetres. The dimensions shown are mean values and apply to standard-specification, unladen vehicles.

¹ Optional extra.

Non-metallic paints

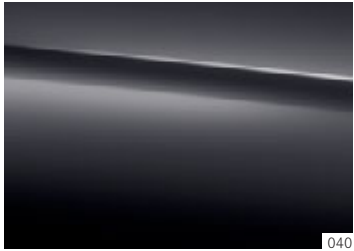

Metallic paints¹

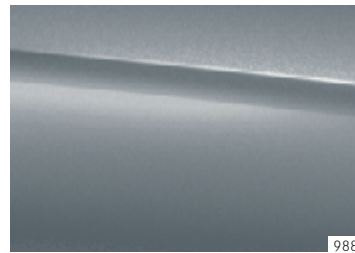
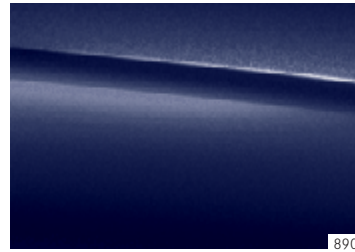
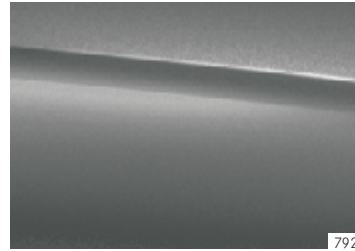
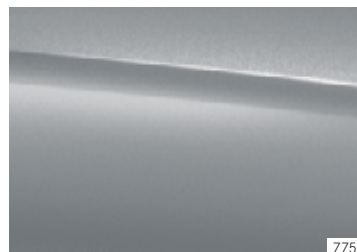
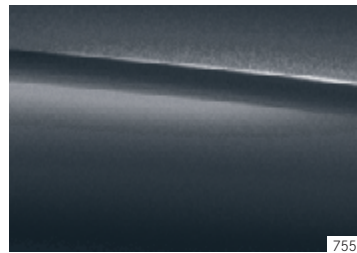
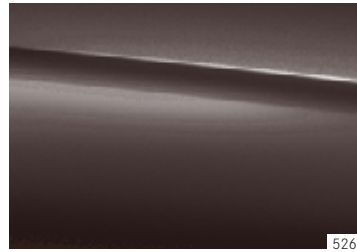
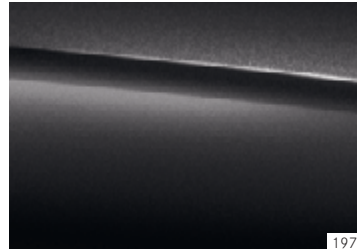

Special paints¹

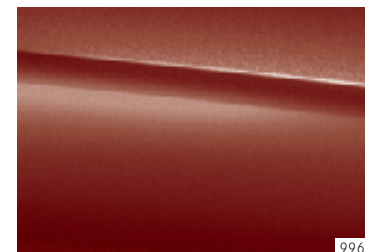
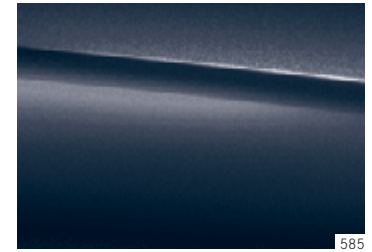
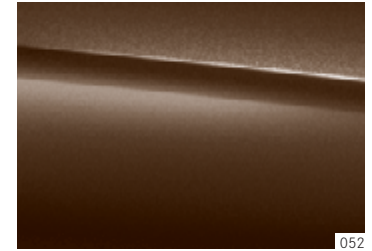
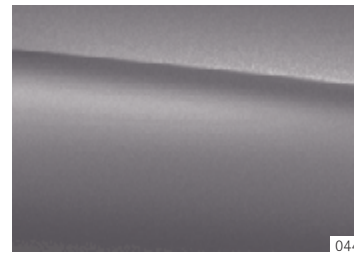
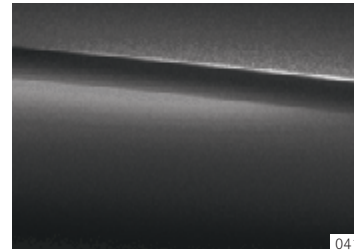
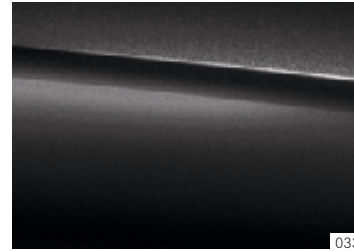

Take-back of end-of-life vehicles. You can return your E-Class to us for environment-friendly disposal in accordance with the European Union (EU) End-Of-Life Vehicle Directive. But that day lies a long way off.

A network of vehicle take-back depots and dismantlers has been established to make it as easy as possible for you to return your vehicle. You can leave it at any of these points free of charge and, by doing so, make an important contribution to completing the recycling process and conserving resources.

For further information about the recycling and disposal of end-of-life vehicles, and the take-back conditions, please visit the national Mercedes-Benz website.

Please note: changes may have been made to the product since this brochure went to press (16.07.2013). The manufacturer reserves the right to make changes to the design, form, colour and specification during the delivery period, provided these changes, while taking into account the interests of the vendor, can be deemed reasonable with respect to the purchaser. Where the vendor or the manufacturer uses symbols or numbers to describe an order or the subject of an order, no rights may be derived solely from these. The illustrations may show accessories and items of optional equipment which are not part of standard specification. Colours may differ slightly from those shown in the brochure, owing to the limitations of the printing process. This brochure is distributed internationally. It provides a general indication of the range of models, features, optional extras and colours available in various countries. Some of the models, features, optional extras and colours shown may not be available in your country or may only be available in a different specification. Additionally some models, features, optional extras and colours may only be available in combination with others. For current and more specific information in relation to the range of models, features, optional extras and colours available in your country, and their pricing, you should contact your nearest authorised Mercedes-Benz Passenger Car Dealer.

www.mercedes-benz.com