



The S-Class.



Mercedes-Benz

This Brochure is prepared by Daimler AG and it predominantly reflects the capabilities and performance of vehicles sold in Europe.

Some characteristics, capabilities, performance features and optional extras (e.g. towing systems) may not be available or may not apply in Australia under Australian conditions. The information in this Brochure is therefore indicative, illustrative and provided only for guidance and should not be relied on. To obtain current and accurate information on a vehicle and any options applicable to Australia, contact your local authorised Mercedes-Benz dealer.

A sunset over a body of water with a city skyline in the background. The sun is low on the horizon, casting a golden glow across the sky and reflecting on the water. The city skyline is visible in the distance, with several tall buildings. The water in the foreground is dark blue with some ripples.

Vision accomplished. The new S-Class.

Roll up those sleeves and get stuck into the job to be done – while sitting in the lap of luxury. Roll up the garage doors in the morning ready to work hard – step out onto the red carpet at night ready to play hard. View the rising sun from the driver's seat – and the setting sun from the reclining seat in the rear. The new S-Class brings together the worlds of work and leisure at a hitherto undreamed-of level. The choice of materials, the degree of perfection and exclusivity in the interior surpass

expectations for a vehicle of this class. And it is simply in the new S-Class's DNA to shine with technical innovations hitherto unseen in a car. The ultra-intelligent chassis seems to flatten down the road ahead; the lighting, using new technologies and a 360° sensor system, illuminates the surroundings with a speed and precision never seen before. You will see it, sense it and experience it for yourself: the new S-Class shows the way ahead – to the future of autonomous driving.

The featured models at a glance:

2 | Mercedes-Benz S 500

diamond silver metallic

AMG Line, featuring AMG 14-spoke light-alloy wheels, Exclusive nappa leather upholstery in black/porcelain, designo sunburst brown high-gloss myrtle wood trim

14 | Mercedes-Benz S 300 BlueTEC HYBRID

magnetite black metallic

7-triple-spoke light-alloy wheels, Exclusive package, Exclusive nappa leather upholstery in silk beige/espresso brown, designo sunburst brown high-gloss myrtle wood trim

26 | Mercedes-Benz S 63 AMG

diamond silver metallic

AMG multi-spoke light-alloy wheels, Exclusive nappa leather upholstery in black, AMG carbon-fibre/piano lacquer trim in black

Some of the innovations in detail:

30 | Intelligent Drive

32 | Stereo camera

34 | MAGIC BODY CONTROL

36 | Seat Comfort package

38 | LED Intelligent Light System

The equipment options at a glance:

42 | Drive system and chassis

48 | Safety

52 | Comfort

64 | Model variant

66 | AMG

76 | Equipment and appointments

94 | Services

96 | Facts and colours

The first star.
Shining in the morning light too.

The sun lifts the veil of mist from the road, the contours of the new S-Class stand out in sharp relief. The upright radiator grille topped by the unmistakable star herald in the new dawn. A new day is breaking – and with it, a new era of mobility.







A rear view of a silver Mercedes-Benz car parked on a rooftop terrace. The car's license plate is 'S W 2226'. The background shows a city skyline and mountains under a sunset sky. The car's rear features include the Mercedes-Benz logo, a license plate with a blue strip on the left, and a rear spoiler.

Prepare to arrive in the future
without covering a single metre of road.

The quickest route between two points
on your agenda.

“The office awaits” – a promise with a pleasant undertone. For even when it comes to the matter of work the new S-Class is an oasis. With air of a purity reminiscent of the coast or forested mountain slopes. Pollutants have to stay outside; ionisation enriches the air in the interior of the luxury saloon. You inhale freedom. Even if you currently find yourself between a handful of skyscrapers and two important appointments.









MERCEDES-BENZ



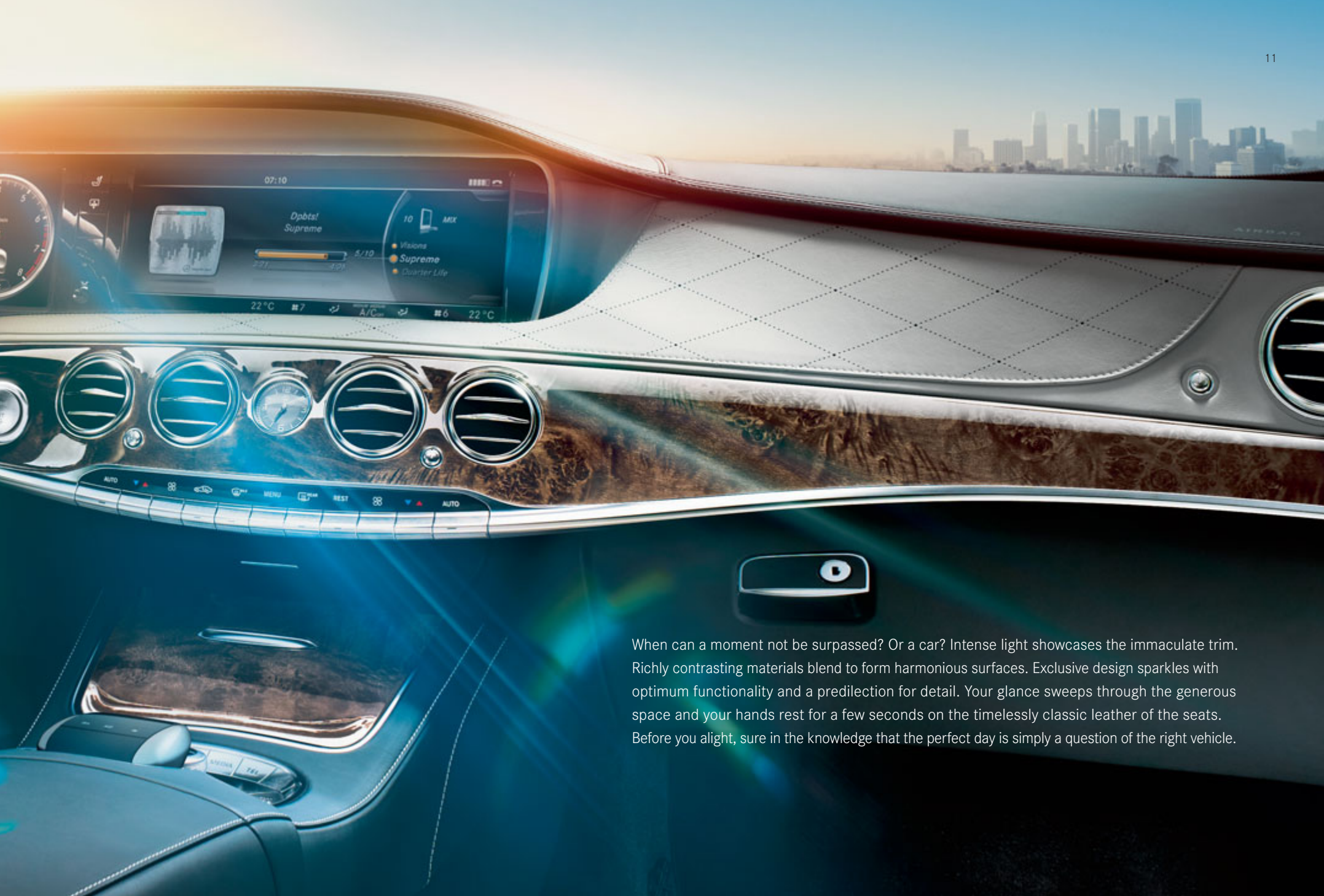

When can a moment not be surpassed? Or a car? Intense light showcases the immaculate trim. Richly contrasting materials blend to form harmonious surfaces. Exclusive design sparkles with optimum functionality and a predilection for detail. Your glance sweeps through the generous space and your hands rest for a few seconds on the timelessly classic leather of the seats. Before you alight, sure in the knowledge that the perfect day is simply a question of the right vehicle.





Nowadays revolutions are
driven from the executive seat.

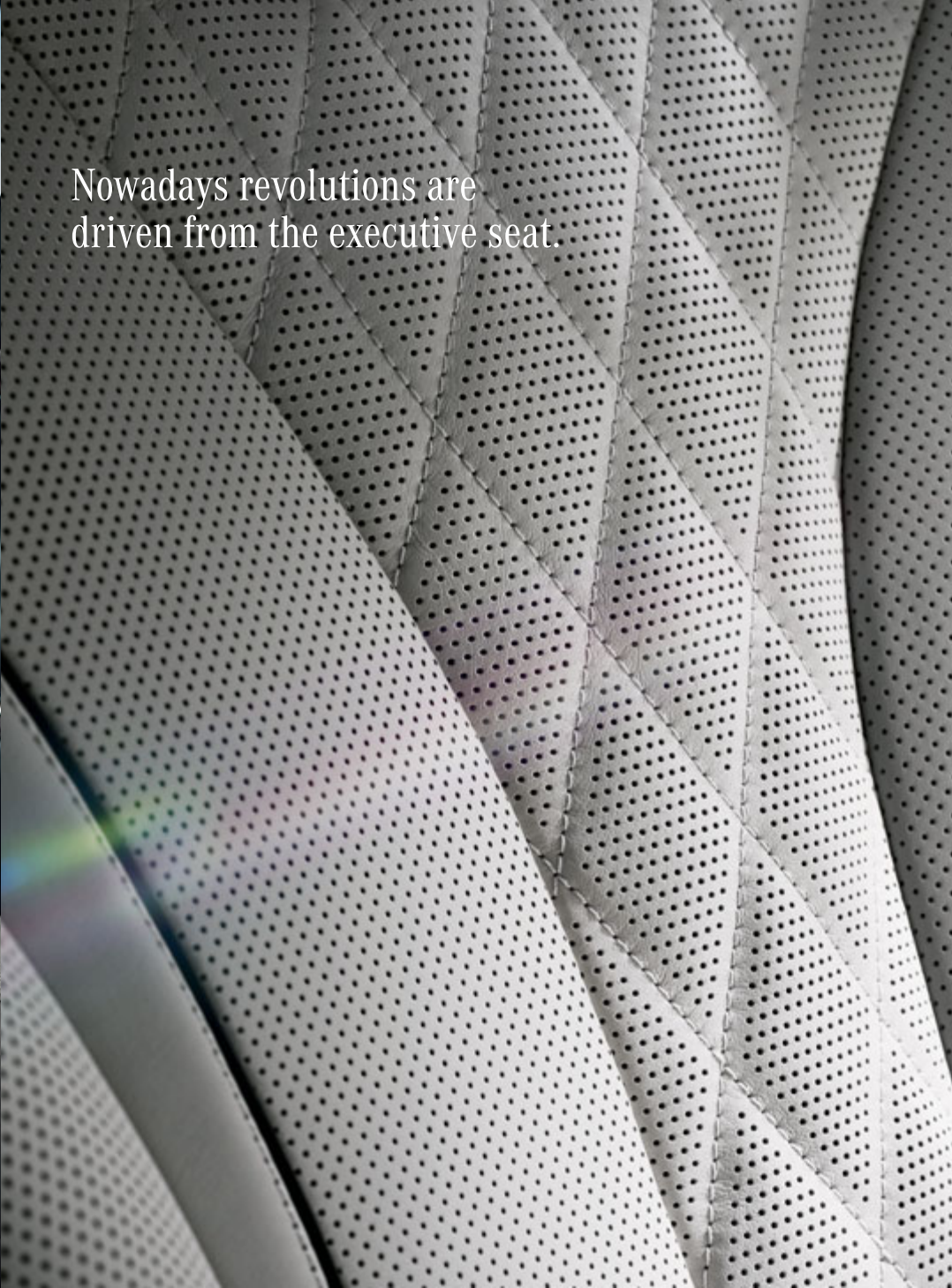



Equally at home with black tie
or white collar.





The time is ripe, the way ahead beckons. Truly there could be no more fitting an opportunity in which to meet up with the future. Its 150 kW plus 20 kW (204 hp plus 27 hp) move mountains as if it were an uphill stroll. The S 300 BlueTEC HYBRID offers outstanding ride comfort with low fuel consumption and emissions.







Recharges its batteries while in motion – as you will do, too.

BLUETEC HYBRID





The new S-Class will always leave you in control
– never alone.

The vision of autonomous driving is at your fingertips as you grip the wheel. The new S-Class uses its camera and sensor technology to capture your surroundings comprehensively and is fully alert to what it records. An intelligent suspension system processes the data gathered in an algorithm, multiplying your safety, comfort and dynamism several times over. Reflection is the better form of reaction.



A close-up, low-angle shot of the front left corner of a Mercedes-Benz S-Class car. The car is dark, and its headlights are on, casting a bright beam of light onto the dark asphalt road. The Mercedes-Benz star emblem is visible on the hood. The license plate is white with black text, reading 'S V 1222'. The background is a dark, hazy night scene with a city skyline visible in the distance under a blue-tinted sky.

Sight machine.

As soon as it gets dark, the eyes of the new S-Class come to life. Optional LED High Performance headlamps go into fully automatic action and reaction, illuminating with precision the areas where they're needed, exactly when they're needed. You can even opt to take the shine off oncoming traffic if you want to avoid dazzling other road users. This gives you optimum vision in practically every driving situation – and above all, a good feeling about where you're headed.



AIRBAG

A close-up, high-angle view of the rear passenger area of a luxury car. The seats are upholstered in light-colored leather with a perforated pattern. The headrests are also upholstered in the same leather. The car's interior is illuminated by soft, ambient light, highlighting the texture of the leather and the stitching. The window on the left shows a blurred cityscape at night.

Where the best deals
are done.



Catapulting your career.







It takes three extraordinary letters to crown a new S-Class: AMG, the fastest way to the top. High-performance technologies which have earned their spurs in motor racing are matched with systematically deployed lightweight materials. The result is a unique combination of luxury saloon and super sports car: the new S 63 AMG. As it is with the technologies, so it is with the materials: only the best, the truly special are used. Carbon-fibre, for example – a material that, thanks to its minimal weight and extreme rigidity, is extensively deployed in Formula 1 racing. Precisely fashioned and finished by hand, it gives the interior of the new S 63 AMG an air of exclusive sportiness.



Mercedes-Benz Intelligent Drive. Look ahead. Think ahead.

Welcome to the automotive future. Which arrived a long time ago as far as the new S-Class is concerned. Lay your hands on the steering wheel and all your senses will link up. The cutting-edge on-board and external sensor systems will see ahead for you, draw conclusions for you, react at lightning speed and thereby prevent accidents. Thanks to radar sensors, a stereo camera, powerful processors and technical assistant systems.

And years of unstinting research. A further milestone from Mercedes-Benz along the path towards greater safety and comfort in road transport and a significant step towards autonomous driving. What will the future bring? The more research we do, the more perspectives that open up. That's how it is with visions. There comes a time when you need a new one. Of and for the future.

Just a second!



A blurred city street scene with cars and buildings, suggesting motion and technology. The image is split into two color-coded sections: a warm, golden-yellow left side and a cool, blue right side. The left side shows a street with cars and buildings, while the right side is a dark, abstract blue space with light streaks.

Everyone has a view on whether it's possible to predict what's coming. Impossible, many would say. A challenge, is what our R&D people reply. But actually, our engineers were not happy with just seeing what's about to happen: they had the ground-breaking idea of wanting to influence the future through actions in the present, for in this way they could help to prevent accidents ever happening. You've surely been there before: you are concentrating on the road ahead, when suddenly a shadow catches the corner of your eye...

In those few critical seconds you're best off benefitting from the results of many years of research. We have developed technologies that allow the vehicle to keep an eye on everything around it. It can see things coming that we can at best only guess at – for example, by calculating where moving objects will move to, and when. Using a stereo camera system that can view things three-dimensionally, in other words spatially. Just like a human can. But can then compute this data so quickly that it is analysed in real time, and can forecast, for example, the future position of a cyclist.

Masterpiece of chassis engineering.



A city skyline is visible in the background, silhouetted against a bright sunset. The sun is low on the horizon, creating a strong lens flare and a path of light that reflects across the water's surface. The water in the foreground is dark and textured, with small waves. The overall scene is a mix of warm orange and yellow tones from the sunset and cooler blue tones from the water and sky.

What do you call something that's ground-breaking? Something that's prepared to leave the tried and trusted behind, to reinvent it. Knowing that the real challenge always lies ahead. Revolutionary? Innovative? Visionary? We call it MAGIC BODY CONTROL. This newly developed chassis technology sets itself up in advance to deal with the road conditions ahead. One could almost say, it relieves the road of its imperfections. This view of the immediate future is achieved through a stereo camera, positioned behind the windscreen,

which observes the road from two perspectives. The huge amounts of data created are transferred to and processed by the control unit for the chassis, in real time. With an accuracy of one to two millimetres at 120 km/h and 25 images per second. The chassis accordingly regulates the amount of oil needed in each of the separately controllable spring struts. In this way the bumps in the road can be almost completely absorbed. At a speed of 130 km/h. Even when cornering, the system always knows what lies ahead.

When you're driving in the new S-Class, arriving is almost incidental. Both for you, and our engineers too. Their aim for every journey is to create a space which becomes yours when you move into it. In a seat that cools you or warms you as desired, and gently tilts backwards until, relaxed and stretched out in the back, you rediscover the meaning of generosity. The measure of all things, which adjusts itself to you, supports your legs and bolsters your back. From the six massage programmes available, you select 15 therapeutic

minutes – relaxing you after what has been, reviving you for what's still to be done. In an exclusive workplace that offers you all you need to make you independent. You will find the unobtrusive technologies at work here, which turn your trip into one of incomparable comfort, intuitive to operate. And when you do get out, you are not just getting out of a car, but of a space specially created for you: the new S-Class.



First Class Business Class.



Light has never been so directed.





There is not much we don't try in our quest to revolutionise every area of automotive engineering and be the first to bring new technologies to the road. So why not put light in the spotlight, and work on it until it is efficient and intelligent enough to be fit for an S-Class? And we don't just mean that the new LED-based lighting technology must illuminate the road surface better, the light temperature must be agreeable and the lights must use up to 25 percent less energy compared to conventional headlamps. S-Class lighting must do more than that. It must interact with the various sensor and assistance systems, such

as the optional Adaptive Highbeam Assist Plus. With the result that if an oncoming vehicle or a vehicle ahead is detected, the area it occupies is simply blanked out in the main beam light cones of the LED headlamps. And when at a standstill, at traffic lights for example, the brake light is automatically toned down so as not to dazzle anyone behind. The more than 190 single-chip LEDs ensure even greater comfort and safety in traffic. So, light can do a whole lot more than just be illuminating. In a Mercedes-Benz at least.

The S-Class in detail.

Drive system and chassis.

- 42 | Diesel and petrol engines
- 43 | S 300 BlueTEC HYBRID and S 400 HYBRID
- 44 | Transmission
- 46 | Chassis and suspension

Safety.

- 48 | Integral safety concept

Comfort.

- 52 | Assistance systems
- 56 | Multimedia systems
- 60 | Seats
- 62 | Lights and climate control

Model variant.

- 64 | S 600

AMG.

- 66 | S 63 AMG
- 72 | S 65 AMG
- 74 | AMG Performance Studio

Equipment and appointments.

- 76 | AMG Line
- 78 | AMG Line Plus
- 79 | Exclusive package
- 80 | Standard equipment
- 81 | Optional extras
- 82 | Upholstery and trim
- 87 | designo
- 90 | Wheels
- 91 | AMG wheels
- 92 | Genuine accessories

Services.

- 94 | Star-quality services

Facts and colours.

- 96 | Dimensions
- 96 | Paintwork
- 97 | Technical data

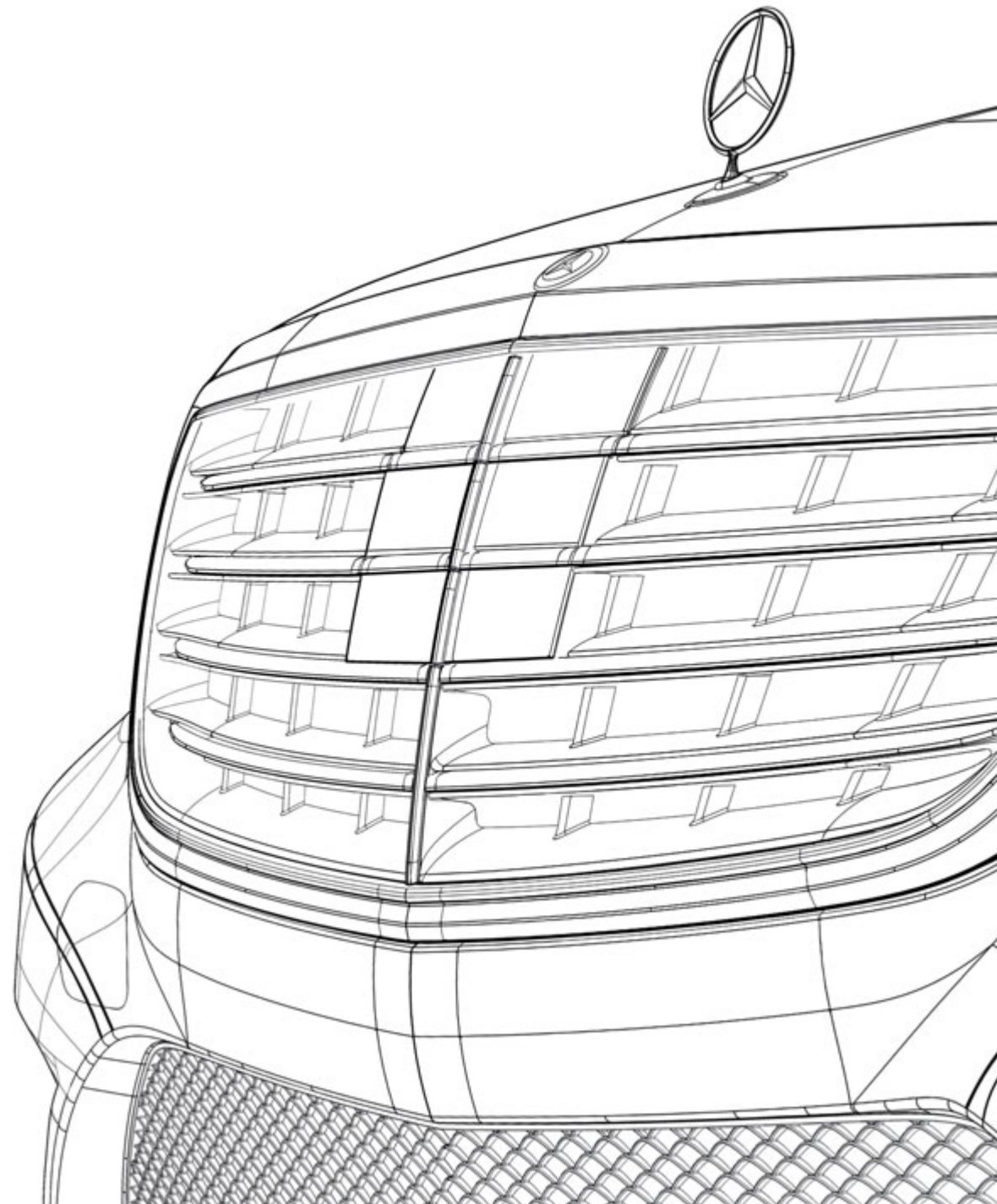

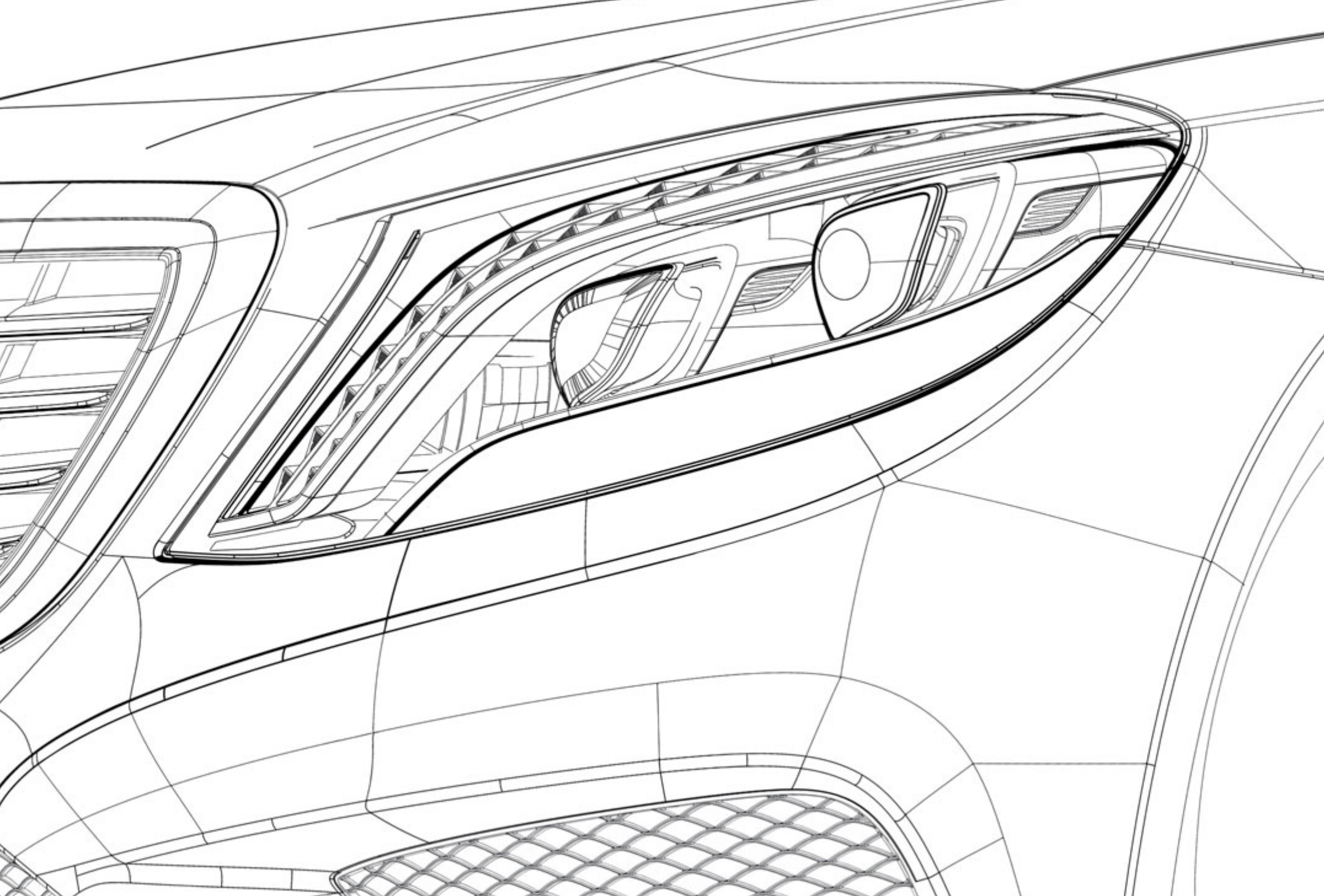

Diesel and petrol engines.

The rule of the road today: you can't have refinement without efficient technologies. Mercedes-Benz diesel and petrol engines are therefore lighter and measure out fuel extremely precisely. In this way they bring together a sense of responsibility and commitment, without compromising on driving enjoyment – no matter what drive system you opt for.

V6 engine. Thanks to systematic lightweight construction, fuel consumption in the S 350 BlueTEC can be as low as 5.5 l per 100 km with an output of 190 kW (258 hp) and a peak torque of 620 Nm. CO₂ emissions are just 155–146 g/km. Plus the BlueTEC technology in the 6-cylinder engine reduces nitrogen oxide emissions substantially, meaning that the S 350 BlueTEC already meets the strict requirements of the Euro-6 emissions standard.

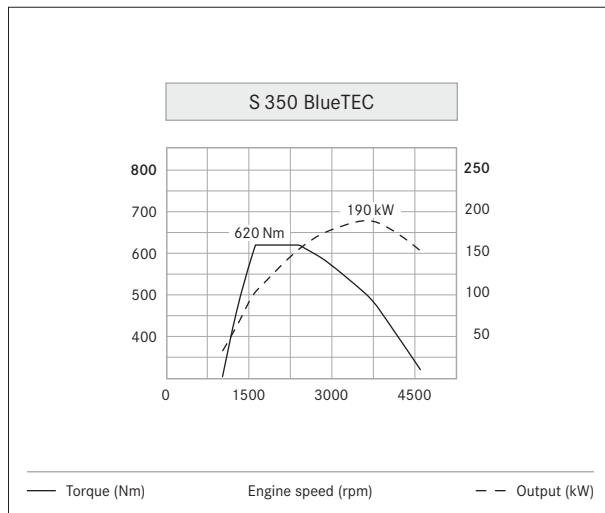

The 6-cylinder diesel engine combines high output with low fuel consumption.

V8 engine. Refinement, driving pleasure and responsibility – embodied by the petrol engine with 335 kW (455 hp). Thanks to twin turbocharging and intercooling, the S 500 has huge reserves of power and can accelerate from 0 to 100 km/h in only 4.8 seconds. The engine may give off its typical, unmistakably sonorous and cultivated sound, but fuel consumption stays exceptionally low.

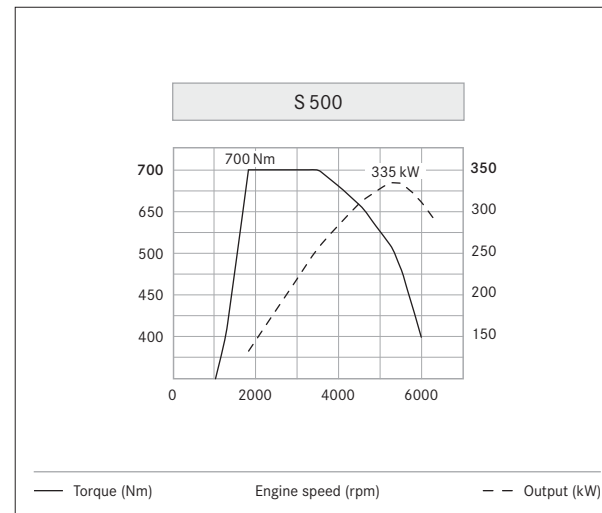

The 8-cylinder petrol engine is powerful, refined and efficient.

V12 engine. The range-topping V12 biturbo engine combines immediate power delivery with environmental awareness. It meets the requirements of the Euro-6 emissions standard and features the ECO start/stop function. So it saves on fuel without compromising its outstanding performance: the torque of 830 Nm is delivered before the rev counter even reaches 2000 rpm, and the 390 kW (530 hp) accelerate the car from 0 to 100 km/h in just 4.6 seconds.

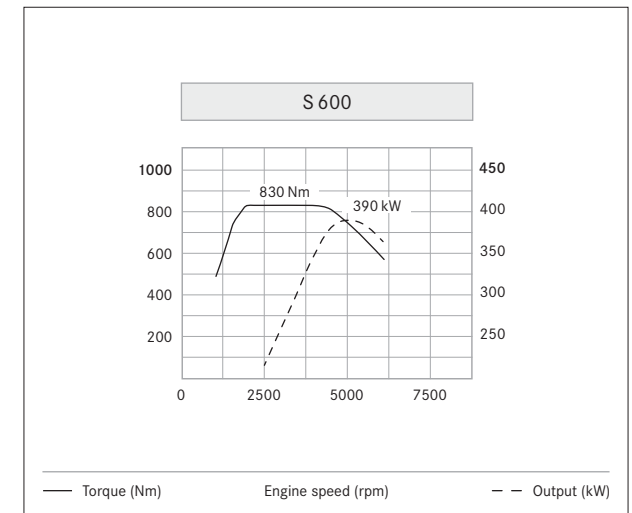

The 12-cylinder petrol engine – superlative power delivery, maximum efficiency.

S 300 BlueTEC HYBRID and S 400 HYBRID.

The particularly efficient and environmentally responsible drive systems combine an internal combustion engine with an electric motor. The interaction of the engines is controlled by high-performance, intelligent electronics. If the vehicle brakes, the electric motor becomes an alternator and produces electricity for the lithium-ion battery.

Environmentally responsible, comfortable and dynamic, all at the same time – that is what is expected of a drive system for the luxury class. In the S 300 BlueTEC HYBRID, Mercedes-Benz combines the 2.2-litre 4-cylinder diesel engine developing 150 kW (204 hp) with a powerful hybrid module. Combined fuel consumption can be as low as 4.4 l per 100 km. These figures are possible thanks to efficiency-enhancing measures such as intelligent light-

weight construction, tyres with low rolling resistance and a drag coefficient (c_d value) of 0.23.

In the S 400 HYBRID, the enhanced 6-cylinder petrol engine is supplemented by an hybrid module which is compact, lightweight and torquey, and which is driven by a high-capacity lithium-ion battery. This drive system delivers an output of 225 kW (306 hp) and, in combination

with the hybrid module, allows fuel consumption as low as 6.3 l per 100 km.

The S 350 BlueTEC and S 400 HYBRID already meet the requirements of the Euro-6 emissions standard. Furthermore, both engines fulfil the strict criteria of efficiency class A and, in the case of the S 300 BlueTEC HYBRID, even class A+.

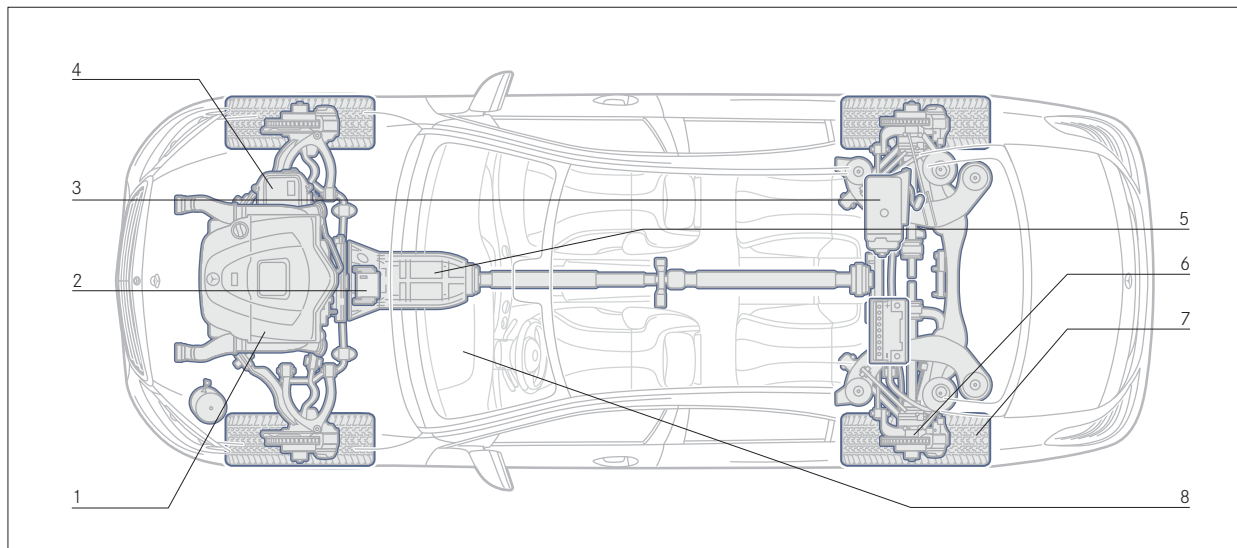

- 1 Efficiency-optimised 4-cylinder diesel engine with 2.2 l displacement (S 300 BlueTEC HYBRID) or 6-cylinder petrol engine with 3.5 l displacement (S 400 HYBRID).
- 2 The compact hybrid module is located between the internal combustion engine and the automatic transmission.
- 3 The powerful lithium-ion battery has a high energy density yet its dimensions are compact and it is light in weight.
- 4 The power electronics coordinate the intelligent and efficient work performed by the internal combustion engine and electric drive system.
- 5 The 7G-TRONIC PLUS automatic transmission ensures imperceptible switching between the power sources and acceleration without interruption of tractive power.
- 6 Recuperative braking system: when braking, the electric motor becomes a generator and produces electrical current for the lithium-ion battery.
- 7 Tyres with low rolling resistance for comfortable and economical motoring.
- 8 The energy flow and drive system battery charge level are indicated constantly on the hybrid display.

Transmission.

The consumption and efficiency-optimised 7G-TRONIC PLUS automatic transmission stands out by virtue of its high level of efficiency, ultra-smooth gear changing, dynamic response and reduced noise levels.

7G-TRONIC PLUS. The 7-speed automatic transmission combines a high level of comfort with driving pleasure and efficiency. The seven forward gears allow a wide ratio spread with low engine speed increments between the individual gears. This leads to fast-responding, fuel-efficient gear changes with pleasantly smooth transitions. As 7G-TRONIC PLUS is able to skip individual gears, multiple downshifts are possible for fast and powerful sprints. The shift characteristics can be preset from economical to dynamic with the transmission modes “Economy”, “Sport” and “Manual”. In “Manual” mode, drivers with sporty inclinations can switch gears manually using the DIRECT SELECT steering wheel gearshift paddles – as in motorsport.

DIRECT SELECT. The DIRECT SELECT gearshift includes the DIRECT SELECT lever on the steering column which serves to change between P, R, N and D. It is additionally possible to shift gear manually using the DIRECT SELECT shift paddles.



DIRECT SELECT lever on steering column. The driver can also change up or down a gear manually using the additional shift paddles.

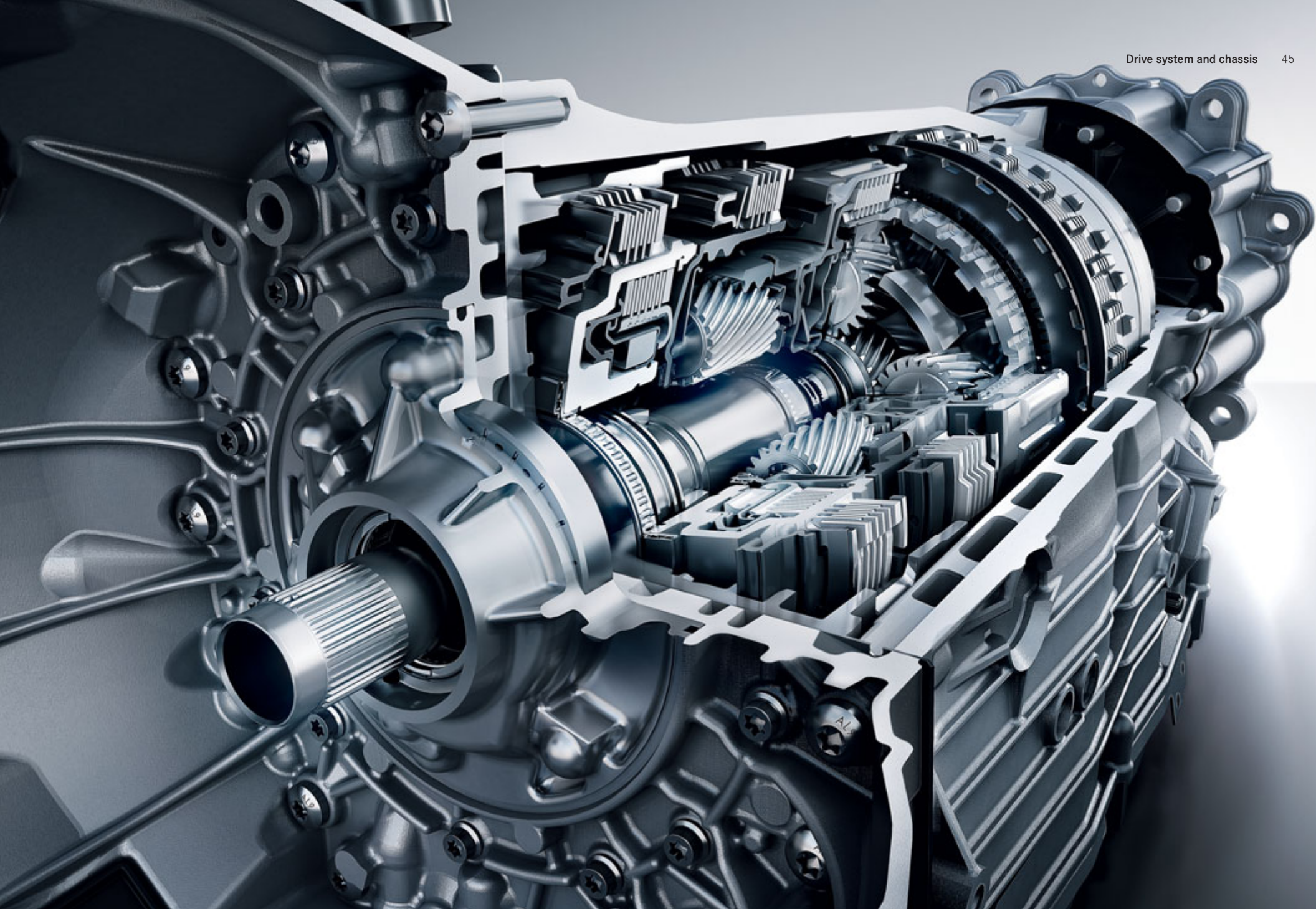

Chassis & suspension.

The new S-Class is fitted with the latest-generation, enhanced AIRMATIC suspension system as standard. The innovative MAGIC BODY CONTROL – a technological milestone, premiered in the new S-Class – is available as an alternative.

AIRMATIC (standard). In combination with variable damper control, the air suspension system ensures ride comfort and dynamic handling at a very high level. The damping at each wheel is adapted to the current driving situation, and can be set for more comfortable or sporty characteristics as required.

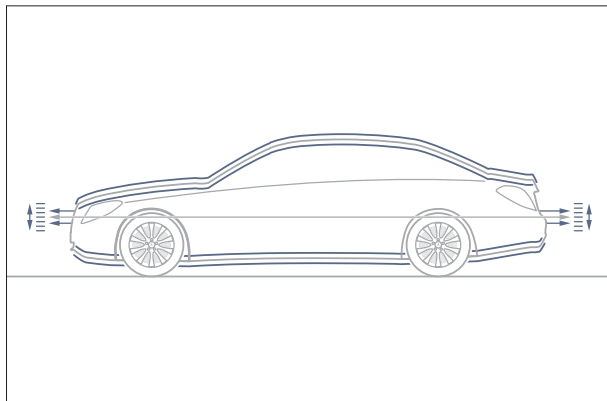

AIRMATIC air suspension ensures comfort and agility through its ability to raise and lower the suspension settings as required.

Crosswind Assist (standard). In strong, gusty crosswinds there is a danger of the vehicle being blown off course. Crosswind Assist is able to recognise this and help the driver to keep the vehicle on course. Using the ESP® sensors, course-correcting braking intervention is performed automatically. This braking intervention takes place at the wheels on the side of the vehicle facing the crosswind. The resulting yawing motion around the vertical axis counters the effect of the crosswind. This reduces track offset considerably. In this way Crosswind Assist gives the driver a greater feeling of safety and helps to avoid inappropriate reactions, especially when sudden gusts strike the vehicle.

MAGIC BODY CONTROL (option). This dynamically oriented suspension system adjusts for undulations or bumps in the road before the car passes over them. This is made possible by the combination of the active springing of the suspension system with the ROAD SURFACE SCAN function. With the aid of a stereo camera the condition of the road surface ahead is captured in detail. From the data gleaned the system calculates in a split second the correct strategy for adjusting in advance the damping of each wheel so as to deal in the best possible way with the unevenness ahead.

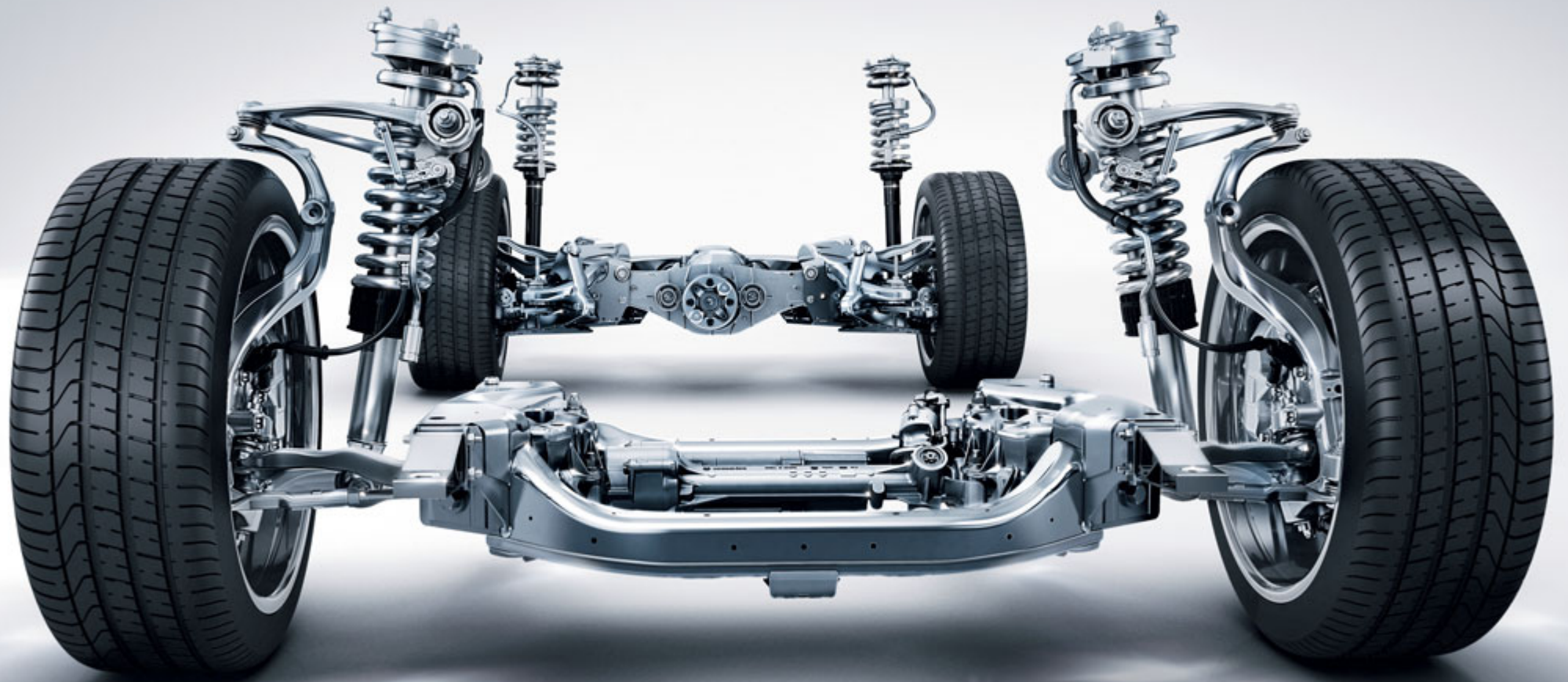

Integral safety concept.

We are driven by the vision of accident-free driving. Our integral safety concept takes us a step closer to achieving this. It is a comprehensive approach which paves the way for new, synergy-based technological solutions, a case in point being the “Mercedes-Benz Intelligent Drive” system which combines comfort and safety.

As the inventor of the motor car we feel a special responsibility for road safety. That’s why we became the first car manufacturer to develop an integral safety concept that seamlessly combines active and passive safety measures to provide comprehensive protection. The holistic approach is divided up into four phases and offers safety solutions for every situation. These include systems for safe driving, which help prevent hazards by providing timely alerts and assistance. Our unique PRE-SAFE® system is triggered in response to danger and activates anticipatory measures to protect the occupants. If a collision should occur despite these precautionary measures, other technologies provide the required protection. We have also considered the time immediately after an accident by developing solutions that can prevent serious injury and enable the emergency services to provide rapid assistance. A selection of these technologies for the “Safe driving”, “In the event of danger”, “In an accident” and “After an accident” phases is presented on the pages which follow.

Safe driving: Driving Assistance package Plus (option).

This packages comprises numerous safety and assistance systems such as DISTRONIC PLUS with Steering Assist and Stop&Go Pilot, the PRE-SAFE® Brake, Brake Assist BAS PLUS with Cross-Traffic Assist, Active Blind Spot Assist, Active Lane Keeping Assist and PRE-SAFE® PLUS. These Mercedes-Benz Intelligent Drive technologies help to relieve driver strain, reduce the risk of accident and improve protection for both the occupants and other road users.

DISTRONIC PLUS with Steering Assist and Stop&Go Pilot helps the driver to keep a safe distance from the vehicle in front and also to remain in the centre of the lane. In this way, the system provides a great deal of stress-relieving comfort, especially on long journeys and when following vehicles in a traffic jam. Brake Assist BAS PLUS with Cross-Traffic Assist and PRE-SAFE® Brake can reduce the risk of accident at junctions, rear-end collisions and collisions with pedestrians, particularly in urban traffic.

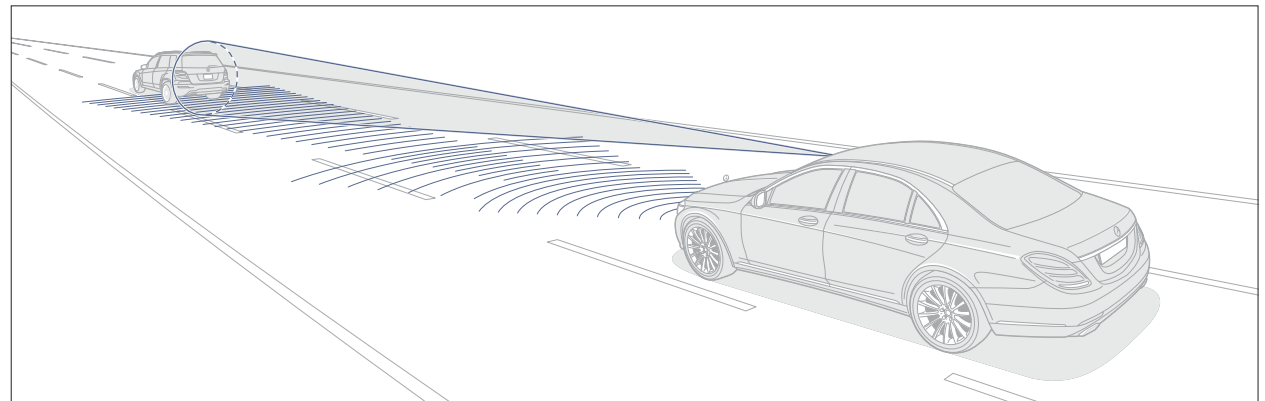

DISTRONIC PLUS with Steering Assist and Stop&Go Pilot takes the strain off the driver in both moving and stop-and-go traffic.

Active Lane Keeping Assist and Active Blind Spot Assist provide assistance if the vehicle leaves its lane unintentionally or during lane changes if there is a danger of collision with other vehicles. One-sided braking intervention can help return the vehicle to its lane and prevent an accident. PRE-SAFE® PLUS extends the functions of the PRE-SAFE® occupant protection system with preventive measures when a rear-end collision threatens.

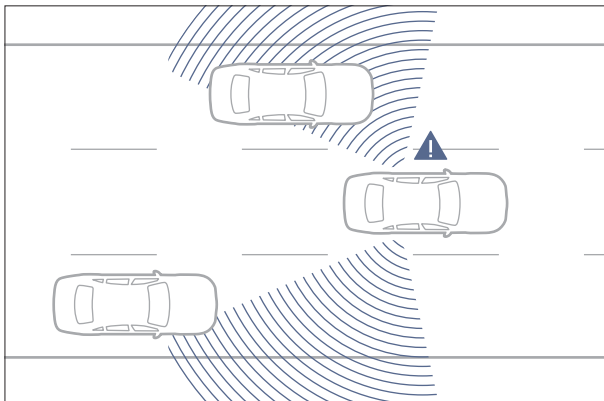

Active Blind Spot Assist monitors the difficult-to-see areas to the left and right of the car.

Safe driving: Night View Assist Plus (option). Only 20 percent of all traffic travels at night, yet 40 percent of fatal accidents occur during this time. Night View Assist Plus makes it possible for the driver to spot people or animals sooner in the dark. They are clearly shown up in the multifunction display in the instrument cluster. Here the combination of two infrared cameras that provide a very high-resolution image and thermal image signature is unique



Active Lane Keeping Assist can intervene to correct the vehicle's direction if it inadvertently changes lane.

in the world. The Spotlight function enables endangered pedestrians across the entire width of the road to be flashed at four times, so that the driver registers them even more quickly and the pedestrians themselves recognise the danger. As standard the night view image only appears automatically when a hazardous situation is recognised.



Night View Assist Plus highlights any people it has recognised and helps the drivers to react quicker to dangers by night.

In the event of danger: PRE-SAFE® anticipatory occupant protection system (standard). This preventive occupant protection system is able to detect critical driving situations in advance and activate safety systems as a precaution. To do this, the PRE-SAFE® system permanently evaluates the data from systems such as ESP® and BAS, allowing it to analyse severe understeer, oversteer and emergency braking, for example. If a critical situation is detected, the front seat belts can be tensioned reversibly and the side windows can be closed so that, should there be an impact, the full extent of the available protection is provided.

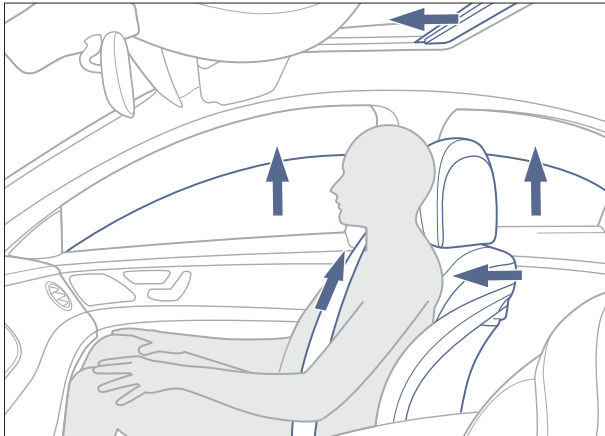

The PRE-SAFE® anticipatory occupant protection system can mitigate the consequences of accidents.

In the event of danger: PRE-SAFE® PLUS (component of the optional Driving Assistance package Plus). If a rear-end collision threatens when at standstill, this extension of the PRE-SAFE® system is able to initiate additional preventive occupant protection measures. These include warning the following traffic by activating the rear hazard warning lights at high frequency and locking the vehicle brakes when at a standstill if the driver indicates that he wishes to remain stationary.

In the event of danger: BAS PLUS with Cross-Traffic Assist (component of the optional Driving Assistance package Plus). The anticipatory Brake Assist system BAS PLUS determines the braking pressure required to prevent a collision or reduce the accident severity. It then makes this pressure available, from light application of the brakes by the driver to maximum braking power. BAS PLUS can also intervene to assist the driver in situations involving crossing traffic. Plus the system is able to detect pedestrians in the area ahead of the vehicle and boost the braking power when the driver presses the brake pedal.

In the event of danger: PRE-SAFE® Brake with pedestrian detection (component of the optional Driving Assistance package Plus). PRE-SAFE® Brake assists the driver in convoy traffic (vehicles ahead or stationary obstacles) when a rear-end collision threatens and the driver shows no responses to counter the danger. The aim is to warn an inattentive driver of an imminent rear-end collision. PRE-SAFE® Brake obtains its situational information from onboard long-range and short-range radar sensors. Plus it allows detection of pedestrians when used in conjunction with a stereo camera. This means that collisions with pedestrians can be avoided up to a speed of 50 km/h.

In an accident: PRE-SAFE® impulse (standard). During a frontal impact the driver and front passenger are subjected to very high loads. In the early phase of a frontal impact, PRE-SAFE® impulse tensions the seat belts of the front seats. In the process the front seat occupants are accelerated against the direction of the impact and drawn more deeply into their seats. When the peak loads occur, this retraction is relaxed as a controlled process. Pre-acceleration and force limitation enable the occupants to be temporarily isolated from the crash. This allows PRE-SAFE® impulse to significantly reduce the risk of injury.

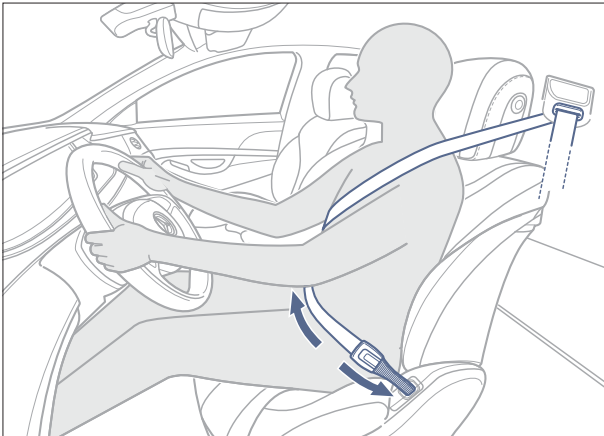

PRE-SAFE® impulse: the seat belts can move the front occupants away from the collision direction in the early stages of a frontal impact.

In an accident: Airbags (standard). The new S-Class has eight airbags as standard in total. In addition to the impact bags, there are sidebags and windowbags for the driver and front passenger. There are also sidebags in the rear and optional beltbags for the outer rear seats. The beltbag, a type of inflatable belt strap, reduces the load exerted on the chest during a crash. If there is an accident, the beltbag strap inflates to almost three times its normal width. The loads acting on the occupants are distributed over a wider area, correspondingly reducing the loads on the chest area.

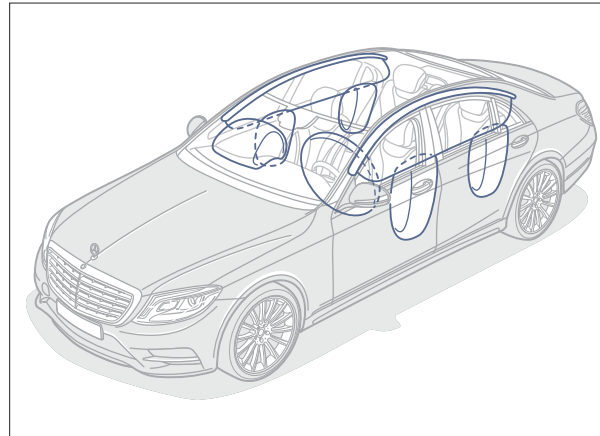

A total of eight airbags as standard can protect you and other vehicle occupants in the event of an accident.

After an accident: Mercedes-Benz emergency call system. This system is able to send an automatic emergency call using a working mobile phone connected to the vehicle as soon as the restraint system recognises an accident. At the same time it communicates GPS positional data and other information to the Mercedes-Benz emergency call centre. Then a voice connection is established, which can be in the relevant national language in practically all countries. This makes it easier to initiate rescue, recovery or towing to a Mercedes-Benz service outlet within a short time.

Measures after an accident. In order to mitigate consequential damage and, where necessary, expedite the rescue of the occupants, Mercedes-Benz has developed further measures. These include the automatic engine cut-off, for example, or activation of the hazard warning lamps and interior emergency illumination. The central locking opens automatically, and crash joints between the door and the wing make it easier to open the doors after a frontal impact. Mercedes-Benz also provides multilingual rescue guidelines which emergency services can download online worldwide at www.mercedes-benz.de/rettungslleitfaden. As you can see, Mercedes-Benz offers well thought-out safety whatever the situation.

Assistance systems.

The new S-Class does not just influence its surroundings – it records them, with short and long-range radar, stereo and infrared cameras and ultrasound sensors working together to give all-round vision, thereby making driving safer and more relaxing.

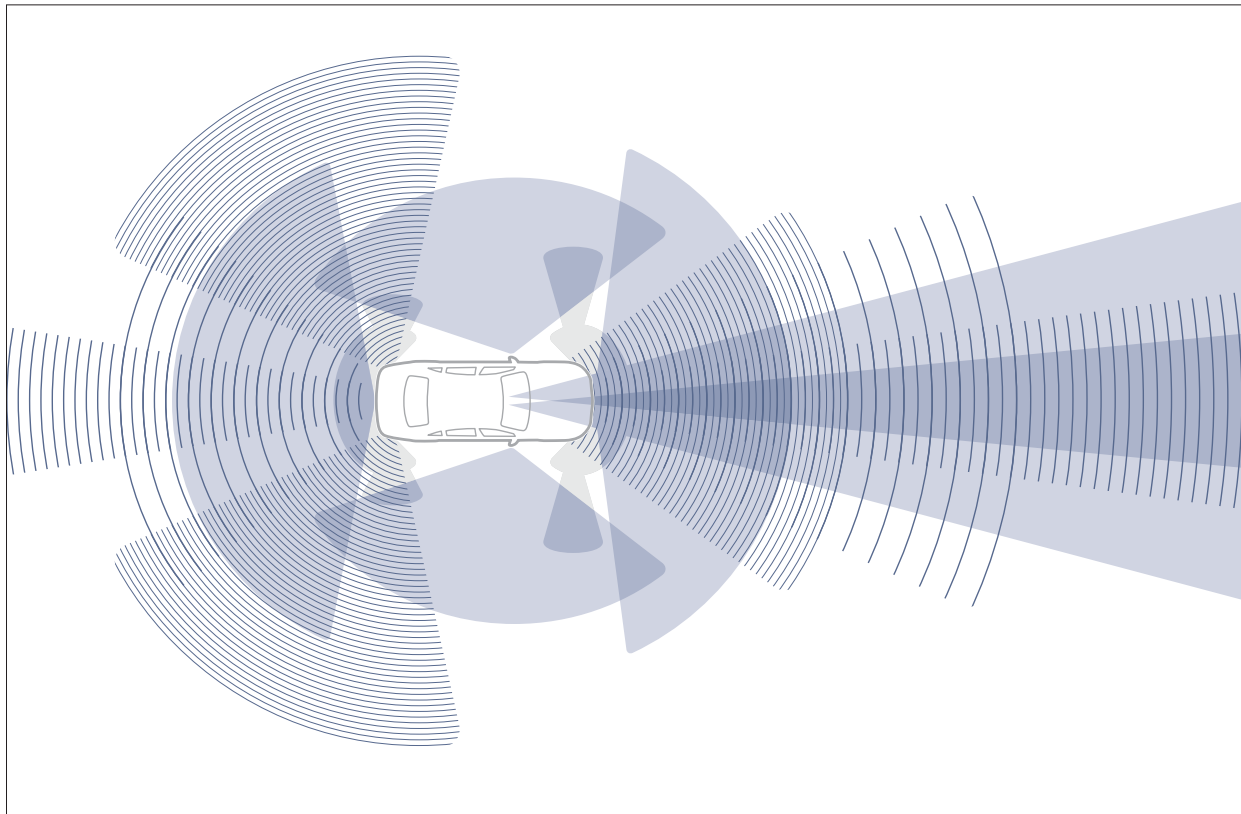

Stereo camera (option). This can capture objects and pedestrians passing in front of the car and calculate the path they will take. Intelligent algorithms evaluate the data and, for a large area of vision, can recognise and allocate in terms of space vehicles, pedestrians and different types of traffic signs and road markings that are oncoming, moving ahead or crossing the path of the car.

360° camera (option). This system allows you to park and manoeuvre, giving you an all-round near real-time view using four networked cameras. The vehicle and its surroundings can be displayed in a bird's-eye view on the COMAND Online display; and obstacles below the level of the windows are also displayed to the driver.

A stereo camera, short and long-range radars and all-round sensor systems form the basis for numerous safety and assistance systems in the new S-Class.



Parking package (option). Active Parking Assist with PARKTRONIC and a reversing camera makes finding a parallel or car-park parking space and parking in it easier. If so desired, it will automatically guide the vehicle into parking spaces and spares the driver the steering and braking actions. If the driver selects reverse gear, and accepts the space suggested, Active Parking Assist automatically performs the required steering movements to manoeuvre the car into the space at a speed of up to 10 km/h. All the driver has to do is operate the accelerator and brake pedals. The parking manoeuvre is completed in a maximum of seven moves.



The stereo camera surveys an area of up to 500 metres ahead of the car and detects where there are parking spaces.

Traffic Sign Assist¹ (component of COMAND Online). This assistance system can recognise speed limit and no-overtaking signs as well as the signs indicating the restriction is lifted and show these in the instrument cluster and the map view of the COMAND display to inform the driver. If the vehicle turns into a street displaying a no-entry sign, a visual and audible warning message is displayed/issued in the instrument cluster (wrong-way warning).



Traffic Sign Assist can recognise speed limit signs and show the speed limit on the display.

LED Intelligent Light System (option). For the best possible visibility on country roads and motorways, when cornering, on bends and in foggy conditions, the low beam mode of the LED Intelligent Light System automatically adapts to the weather, lighting and driving conditions. Adaptive Highbeam Assist Plus allows continuous long-range illumination of the road ahead without dazzling oncoming traffic or vehicles ahead. Plus the high beam is dimmed automatically for road signs that reflect its light back strongly. The LED Intelligent Light System thus makes a key contribution to safe driving.

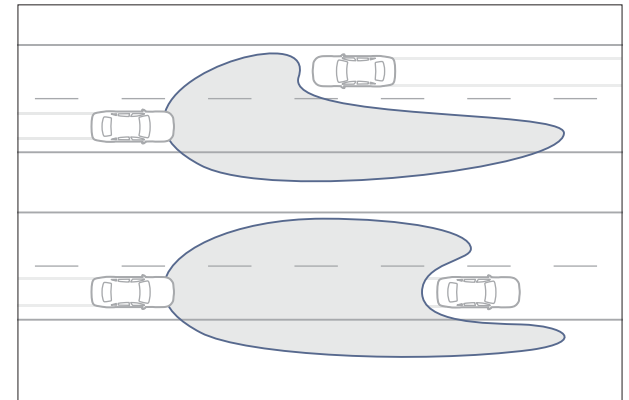

Adaptive Highbeam Assist Plus always provides the best possible headlamp range automatically, thereby improving visibility for the driver.

¹ Traffic Sign Assist is configured specifically for the country in which it is used.

Warmth Comfort package (option). On cold days the Warmth Comfort package quickly provides cosy warmth. The armrests on the centre console and the doors can be heated in addition to the seats. The armrest in the middle rear seat can be additionally heated if electrically adjustable rear passenger seats are fitted. The driver and the passengers on the outer rear seats are able to choose between three different heating levels at the touch of a button. The surfaces to be heated can be selected via COMAND Online. Additional highlight: the heated steering wheel.



With the Warmth & Comfort package, the vehicle occupants can each choose one of three heat settings.

Touchpad (option). Something else for your hands to look forward to in addition to the steering wheel: the newly developed touchpad allows you to control telematics functions using one or two fingers. Plus letters, numbers and symbols can be entered using natural handwriting. Furthermore, there are three touch-sensitive keys behind the pad, which can be used to control important functions quickly and directly. The touchpad is therefore an additional fully featured input device alongside the COMAND Controller and LINGUATRONIC.



The touchpad allows convenient control of telematics functions using one or two fingers.

Head-up display (option). In addition to your destination, you now see in front of you everything of importance relating to the route that takes you there: the head-up display posts information such as the car's speed, speed limits and navigation instructions within your field of vision. A special light sensor optimises the legibility of the display whatever the light conditions. The image height is customisable, as are the various display contents, which you can activate or deactivate as required.



The head-up display posts information directly within the driver's field of vision.



10:10

Titanics
Mercedes-Benz Mixed Tape

00:04 02:46

1/30

Low Frames

20°C

3

DIFFUSE DIFFUSE
A/C ON

4

24°C

Multimedia systems.

On the way to work or working already? Different media requirements and options have already been taken into account with the new S-Class. The new Mercedes-Benz Connect functions can be operated just as intuitively as the familiar ones.

COMAND Online (standard). Navigation, telephone, audio, video, internet – with the COMAND Online control and display system the driver keeps these and many other functions in sight and under control. Information is shown on a 31.2 cm high-resolution colour display. Operation is easy and intuitive. Fast hard-disc navigation with realistic topographical map display for relaxed route guidance.

In combination with a suitable mobile phone it is possible to call up internet pages when the vehicle is stationary, and to use Mercedes-Benz apps such as POI search, weather or internet radio while driving. The integrated WLAN hotspot also allows integration of a notebook or tablet PC. A DVD player, radio, 10 GB memory for audio and video files and ports for connecting external devices provide made-to-measure entertainment.

Live Traffic Information¹ (component of COMAND Online). This service allows the reception of up-to-date and precise traffic information in real time for optimised dynamic route guidance and a more accurate estimated time of arrival. Data transfer is via a communication module which provides the internet connection with its own SIM card including data roaming.



COMAND Online displays all the information and communication functions for the new S-Class on a high-resolution colour display.



The optional handset with touchscreen serves both as a telephone and as a remote control for the seat functions of the optional Rear Seat Comfort package.

¹ 3 years of free use, available in 12 countries.



When driving at night the illuminated tweeter lenses of the Burmester® high-end 3D surround sound system really come into their own.

Burmester® high-end 3D surround sound system (option). 24 high-performance loudspeakers, 24 amplifier channels with a total system output of 1540 watts and technologies developed exclusively for the vehicle guarantee unprecedented listening enjoyment. The combination of analogue and digital elements produces an extraordinarily expressive and fascinating 3D sound. In addition to the acoustic highlights, the Burmester® high-end 3D surround sound system impresses with visual effects: two tweeters installed in the mirror triangles of the front doors move into the most favourable position when the system is switched on, lighting up in one of seven freely selectable colours if the ambient lighting is active.

Burmester® surround sound system (option). 13 high-performance loudspeakers and electronic and acoustic elements which have been precisely aligned to the vehicle interior provide the first-class Burmester® feel-good sound. The sound experience can be further intensified with the surround function or the sound optimisation for the front and rear seats.

SPLITVIEW (option). The 31.2 cm COMAND Online display enables the front passenger to enjoy films in brilliant picture quality while the driver follows the navigation instructions, for example. This is made possible by SPLITVIEW, which is able to show different content simultaneously on the same display depending on the viewing angle. A high-quality radio headset treats the front passenger to first-class sound without disturbing the driver. The front passenger

has convenient access to the entertainment source of his or her choice by remote control – movies on DVD, radio, internet or television in conjunction with a TV receiver. Content from MP3 players, game consoles or an iPod® is also available via the AUX-in socket.

Individual Entertainment System in the rear (option). DVD films, internet, video games, music – the Individual Entertainment system gives passengers in the rear their very own personal entertainment programme. Two 25.4 cm displays and wireless headphones for brilliant picture and sound quality.



SPLITVIEW displays two different images at the same time – for the driver and front passenger – on a single screen in the centre console.

Part of the Individual Entertainment System in the rear: the 25.4 cm displays.

Seats.

Sitting in the new S-Class is not just comfortable, it can also increase your ability to keep driving well. Quite apart from individually climatized seats plus 60 possible settings from the seating area through to the steering column, there is a massage function and a special relaxation cushion for the rear seat.

ENERGIZING massage function (option). Six different programmes are available, including two hot relaxing massage programmes, which can relax, stimulate or mobilise you according to your wishes; and can be selected for both the front and the rear seats. “Strong” or “weak” intensity levels can be set. The speed and effect varies according to programme. Each programme lasts between 12 and 15 minutes.



The ENERGIZING massage function is operated through COMAND Online.

Climatized front and rear seats (option, standard for S 600 and S 65 AMG). The active ventilation function of the climate-controlled seats rapidly cools the seat surfaces to a pleasant temperature. On cold days the on-demand seat heating provides cosy warmth as required. Seat ventilation and seat heating can be independently set in three stages at the touch of a button.

Memory package (option, standard for V8 and V12 engines). If the driver and front passenger change places frequently, the Memory package offers particular operating convenience. Up to three different positions for the power front seats, steering column and exterior mirrors can be stored at the touch of a button and retrieved.

First Class Rear (option). The continuous Business console transforms the rear into a mobile office with two individual seats. Two USB connectors, two 12-volt sockets and two temperature-controlled cupholders, as well as optional features such as folding tables, make for a comfortable travelling and working environment.

Executive seat (option). With the Executive seat the rear-seat passenger behind the front-passenger seat can enjoy even long journeys in absolute relaxation. The seat can recline into a comfortable lying position at the push of a button. The combination of legrest and footrest creates a comfortable bed.

Chauffeur package (option). The front passenger seat can be electrically moved further forward by up to 77 mm. This enables the passenger seated behind it to enjoy the journey even more. The noticeably longer legroom allows a more comfortable resting position. This is assisted by an electrically extending footrest.

The designo Exclusive nappa leather upholstery in deep sea blue/silk beige shown in the picture is only available for the Edition 1.





Light and climate control.

Perfection means attending to everything, even the air. The AIR-BALANCE package ionises the air and cleans and scents it with one of four atmospheric scents, if so desired. In this way, it does not need to be down solely to the ambient lighting to create a first class relaxing or stimulating S-Class atmosphere.

Ambient lighting (option, standard for the long-wheelbase version and the S 500, S 500 4MATIC and S 63 AMG). With its pleasant and indirect light, the ambient lighting creates a unique feeling of well-being throughout the whole of the interior. Seven different colours and five dimming levels are available to create a personalised lighting mood.

AIR-BALANCE package (option). The vehicle interior can be fragranced to preference with the AIR-BALANCE package. There is a choice of four high-quality interior fragrances according to personal preference and mood. In addition, the air quality can be improved by oxygen ionisation and filtering of the incoming air.

THERMOTRONIC automatic climate control (standard). With two climate zones and three air flow settings, the automatic climate control creates an individual climate of well-being on board. The driver and passenger can set their temperatures independently of each other. There are five different and separate settings for the temperature of the footwells in the front. An active carbon filter for fine dust keeps dust, soot and pollen at bay and reduces smells and pollutants in the air.



The AIR-BALANCE package, which is inclusive of ionisation, air filtering and scenting, provides first class S-Class air quality.

S 600.

Excellence – expressively showcased and impressively delivered: the new S 600 with V12 engine.

Seldom has performance been brought to the road with such aplomb. The S 600 has a V12 engine developing 390 kW (530 hp) for power delivery that appears to turn every moment into torque. But it is not just the power of the S 600 that leaves a lasting impression – its appearance does, too. Exclusive design elements such as the V12 radiator grille with double louvre and two visible tailpipes

in V12 design further enhance the car's looks. In the interior, the V12 start-up screen plus V12 emblems on the seats and floor mats provide evidence of the car's extra power. In keeping with the refined interior, the S 600 is equipped with a number of exclusive assistance systems as standard, including MAGIC BODY CONTROL, the Driving Assistance package Plus and the LED Intelligent Light System.

Inside the car, the ambience is enhanced with the Exclusive package, the AIR-BALANCE package, the Exclusive trim package and the head-up display. A design which wins the S 600 admiring looks from those who are quick enough to see it as it flashes past.



Exclusive interior.



V12 radiator grille with double louvre and chrome trim.





S 63 AMG exterior.

Power, endurance and speed are the calling cards of the S 63 AMG – as is evident from the first glance. Where the exclusivity of the new S-Class is taken to an even higher level by the expressiveness of AMG.

The S 63 AMG is powered by a V8 biturbo engine with an output of 430 kW (585 hp) and 900 Nm of torque. It is recognisable from the “V8 BITURBO” lettering on the wing. Its power is controlled by an AMG SPEEDSHIFT MCT 7-speed sports transmission system with a Controlled Efficiency drive mode and an ECO start/stop function. AMG sports suspension for the long-wheelbase version

based on AIRMATIC ensures maximum comfort even when driving dynamically.

The athletic-looking saloon is characterised by its AMG-specific front and rear aprons and side skirts, all with silver chrome trim. Black flics in the front apron provide optimum aerodynamics. The sporty-looking AMG forged

wheels, the high-performance brake system, comprising composite brake discs bearing the AMG logo and finished in grey, and the AMG sports exhaust system with two chromed twin tailpipes integrated into the bumper round off its stylish appearance.



The optional 20-inch AMG forged wheels with wheel bolt covers emphasise the exclusive appearance of the S 63 AMG.



The standard 19-inch AMG forged wheels.

S 63 AMG technology.

AMG means having a drive system that will surpass itself time and again. Take the new S 63 AMG, for instance: lower emissions, lower fuel consumption, increased performance with 430 kW (585 hp) and 900 Nm torque. And on top of all this: the AMG drive system is available for the first time in conjunction with 4MATIC all-wheel drive.



The systematic use of lightweight materials has resulted in the S 63 AMG being 100 kilograms lighter than its predecessor. This was achieved through using carbon-fibre and innovative materials, a lithium-ion battery and weight-optimised AMG forged wheels resulting in lowered consumption, lower emissions and even more dynamic driving characteristics. As a technical highlight, the performance-oriented AMG 4MATIC all-wheel drive system is available exclusively for the S-Class long-wheelbase version for the first time. Front to rear axle power distribution of 1/3 to 2/3 provides the high level of driving dynamics and the huge amount of driving pleasure so typical of an AMG model. It also improves handling on wet road surfaces, and effortlessly transfers the enormous AMG power to the road in dry conditions. The AMG SPEEDSHIFT MCT 7-speed sports transmission with a wet clutch helps to boost performance and is designed to be driven sportily – without any compromises on comfort.

Systematic use of lightweight materials and intelligent detailed solutions have made the new S 63 AMG even sportier yet more economical than its predecessor.





S 63 AMG interior.

Two and half years were needed for the development of the new S-Class interior. The objective was to reconcile the demands of extremely ambitious drivers with those of extremely demanding designers.

The sporty appearance of the S 63 AMG continues on into its interior. The AMG-specific seats have been designed for a dynamic driving style and offer reinforced lateral support. AMG metal badges on the front and rear seats signpost the vehicle's pedigree. The standard-fit seats are

upholstered in nappa leather of the very highest quality, with contrasting topstitching. The optional Exclusive package takes the interior's athletic look a step further, with perforated Exclusive nappa leather in a dynamic diamond design. Sports pedals, the AMG steering wheel,

AMG-specific floor mats, AMG door sill panels and an analogue clock with an IWC design round off the sporty appointments.



The single seats in Exclusive nappa leather with a diamond design provide great comfort and plenty of space to allow you to enjoy the trip.



Embossed AMG badge in the centre console.

S 65 AMG.

The new S 65 AMG – performance in its most exclusive form.

This design idiom needs just three letters to impress: AMG. The AMG bodystyling consists of a unique front apron with flics in high-gloss chrome, a rear apron with insert in high-gloss chrome and side sill panels trimmed with high-gloss chrome. Only the eyes looking at these appointments shine more brightly.

An exclusive interior ambience is created courtesy of the finest leather and a lavishly finished trim. AMG sports seats in AMG-specific diamond design offer optimum lateral support. The AMG sports steering wheel is finished in nappa leather with an airbag cover in nappa leather and silver-coloured aluminium shift paddles.

The driving force behind the S 65 AMG is an AMG V12 BITURBO engine that combines immense power with outstanding refinement. Its 463 kW/630 hp are good for a maximum torque of 1000 Nm. In fact, there may only be one thing that is more powerful than the AMG V12: your desire to drive it.



Sporty interior ambience with AMG sports seats and AMG sports steering wheel.



The standard-fit AMG 20-inch multi-spoke forged wheels with optional AMG ceramic high-performance composite brake system.



AMG Performance Studio.

Sportiness that teases the eye: from the carbon-fibre ceramic brake system through to the illuminated AMG door sills, the AMG Performance Studio turns the already fit-looking new S-Class into an out-and-out Olympian package.

The many appointments and equipment options offered by the AMG Performance Studio serve to make the S 63 AMG and S 65 AMG even more exclusive. An AMG ceramic high-performance composite brake system is available for the first time for the new S-Class, for example. It not only ensures the shortest of stopping distances and outstanding resistance to fading, but also offers braking performance normally to be found in motorsport. The AMG carbon-fibre engine cover and red brake callipers also add to the sporty look and feel of the car. The AMG Exterior Carbon-Fibre package gives the S 63 AMG and S 65 AMG a sophisticated appearance with many high-quality carbon-fibre trim elements, such as the inserts in the front and rear aprons, side skirts and exterior mirror housings. The AMG twin-spoke forged wheels in high-sheen titanium grey are equally expressive; alternatively, they are available in a 10-spoke design with a polished titanium grey finish or a matt black

finish, in all cases with 255/40 R 20 front tyres and 285/35 R 20 rear tyres and elaborate forged bolt covers. The dynamic design continues in the interior with carbon-fibre/black piano lacquer trim and an AMG performance steering wheel. Illuminated door sills with AMG lettering and exclusive AMG floor mats also form part of the special AMG Performance Studio range.

And if you're wanting to drive the S 63 AMG or S 65 AMG at its top speed of 300 km/h, you may want to opt for the AMG Driver's package, which includes driver training from professional instructors at the AMG Driving Academy.



The AMG ceramic high-performance compound brake with specially painted brake callipers and "AMG Carbon Ceramic" lettering.

AMG Performance Studio equipment and appointments | Selection.



AMG trim in carbon fibre/black piano lacquer.



AMG Driver's Package, with top speed of 300 km/h.



AMG carbon-fibre engine cover.



AMG door sill panels with "AMG" lettering, with white illumination

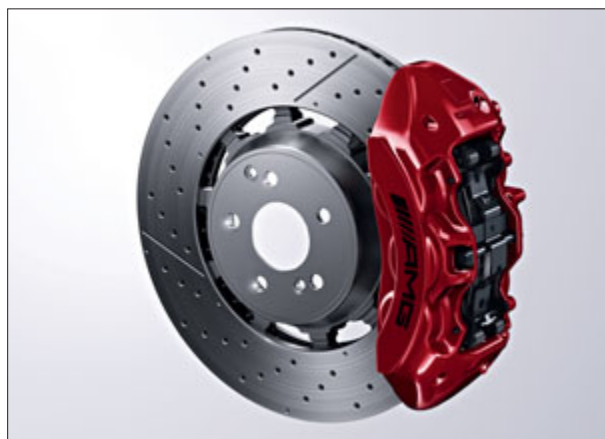

AMG brake callipers, finished in red.



Exterior mirrors in the AMG Exterior Carbon-Fibre package.



AMG Line.

Styling elements that further enhance your car's sportiness and exclusivity.



AMG Line features powerful AMG bodystyling and dynamic light-alloy wheels in a choice of two designs. Sporty interior touches are provided by the high-gloss black poplar wood trim, the AMG sports pedals and a classic multifunction steering wheel in wood/leather.

Exterior

AMG 5-twin-spoke light-alloy wheels, painted in titanium grey with a high-sheen finish, with 245/45 R 19 front tyres and 275/40 R 19 rear tyres

AMG bodystyling (front and rear apron plus side sill panels with inserts painted in vehicle colour)

AMG multi-spoke light-alloy wheels, painted titanium grey with a high-sheen finish, with 245/40 R 20 front tyres and 275/35 R 20 rear tyres (optional)

Chrome trim in rear apron (diesel models)

Perforated brake discs and brake callipers with "Mercedes-Benz" lettering

Two visible tailpipes (petrol models)

Interior

AMG sports pedals in brushed stainless steel with rubber studs

AMG velour floor mats with "AMG" lettering

High-gloss black poplar wood trim

Wood/leather multifunction steering wheel in high-gloss black poplar wood



AMG Line Plus.

Sportiness – taken to the limit.



In addition to the AMG Line features, AMG Line Plus lends the car an even more dynamic look. The carefully matched features include AMG multi-spoke light-alloy wheels painted in high-gloss black with a high-shine finish, AMG sports seats and an AMG sports steering wheel.



Exterior

AMG multi-spoke light-alloy wheels painted in high-gloss black with a high-shine finish, with 245/40 R 20 front tyres and 275/35 R 20 rear tyres

Interior

AMG sports steering wheel

AMG sports seats in nappa leather or Exclusive nappa leather (optional)

Exclusive package.

The stylishly matched combination of high-quality features meets the highest standards for comfort, quality and design.

In addition to the characteristic diamond-patterned seating design along with the contrasting topstitching and piping for the seats, the generous use of nappa leather and wood trim also add to the interior's air of exclusivity. As do other details, such as the illuminated door sill panels with "Mercedes-Benz" lettering, the boot sill finished in stainless

steel and the roof lining and sunblinds covered in classy DINAMICA. The interior of the vehicle can be further stylishly individualised with the trim elements from the Exclusive package. The backs of the front seats are finished in high-class wood, as are the door centre panels and air outlet covers in the rear of the car. The attractive

designo high-gloss sunburst brown myrtle wood trim and designo metallised ash trim (options) complete the Exclusive package.



designo high-gloss sunburst brown myrtle wood trim.



Further wood trim elements in the door centre panels and on the backs of the front seats add to the high-class appeal of the rear.

Standard equipment | Selection.



LED High Performance headlamps.



Twin-spoke multifunction steering wheel in nappa leather with 12 pushbuttons.



THERMOTRONIC automatic climate control.



Electrically adjustable front seats.



DVD player.



Standard loudspeakers with Frontbass technology.

Optional extras | Selection.



LED Intelligent Light System.



Driving Assistance package Plus.



AIR-BALANCE package, including ionisation, air filtering and fragrance.



Head restraint cushions (integral part of electrically adjustable rear seats).



MAGIC BODY CONTROL.



Burmester® surround sound system.

Upholstery and trim.



The black colour scheme stands for masculine elegance. There is a choice of seats in black fabric, leather, nappa leather or Exclusive nappa leather. The roof lining is also in black, as is the armrest and instrument cluster in the centre console in ARTICO man-made leather. The door panels are clad in lavish, hand-sewn material. While the combination with the high-gloss dark brown eucalyptus shows off the aesthetic appeal of the interior to its fullest extent.



001

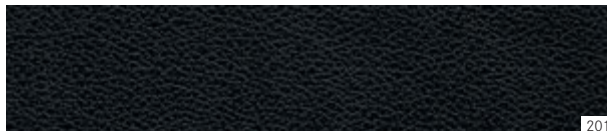

201



801 | 501 | 851 | 561



734



731



729



727



H06



H10



H21

black/black

001 Fabric

201 Leather

801 Nappa leather | 501 Exclusive nappa leather¹851 AMG nappa leather² | 561 AMG Exclusive nappa leather³

Trim

734 High-gloss dark brown eucalyptus wood

731 High-gloss brown burr walnut wood⁴729 High-gloss black poplar wood¹727 designo high-gloss sunburst brown myrtle wood¹H06 designo metallised ash wood¹H10 AMG carbon fibre/designo piano lacquer in black^{1,5}H21 designo piano lacquer^{1,5}

¹ Optional extra. ² Only for S 63 AMG and S 63 AMG 4MATIC. ³ Optional extra only for S 63 AMG and S 63 AMG 4MATIC. Standard for S 65 AMG. ⁴ Optional extra. Standard for S 600 and S 65 AMG. ⁵ Only in conjunction with Exclusive package.



The silk beige/espresso brown colour scheme gives the luxury saloon the character of a sophisticated lounge. The centre console, doors and instrument panel are covered in silk beige leather. The light beige nappa leather seats with their horizontal-fluting design, combined with high-gloss brown trim, looks inviting from the very start. The light-coloured roof lining opens up the space, promising boundless and relaxed journeys.

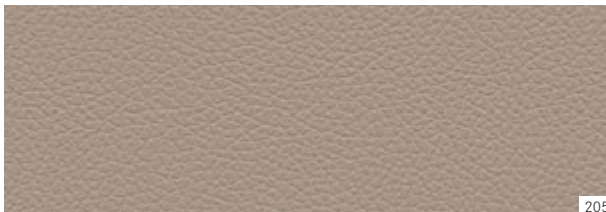

205

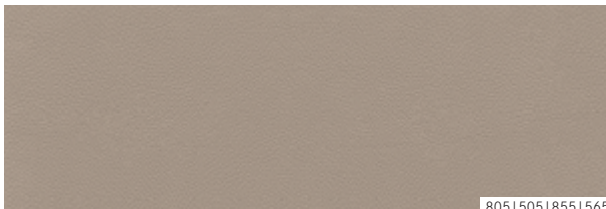

805|505|855|565



734



731



729



727

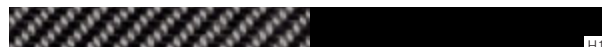

H10



H21

silk beige/espresso brown

- 205 Leather
- 805 Nappa leather | 505 Exclusive nappa leather¹
- 855 AMG nappa leather² | 565 AMG Exclusive nappa leather³

Trim

- 734 High-gloss dark brown eucalyptus wood
- 731 High-gloss brown burr walnut wood⁴
- 729 High-gloss black poplar wood¹
- 727 designo high-gloss sunburst brown myrtle wood¹
- H10 AMG carbon fibre/designo piano lacquer in black^{1,5}
- H21 designo piano lacquer^{1,5}

¹ Optional extra. ² Only for S 63 AMG and S 63 AMG 4MATIC. ³ Optional extra only for S 63 AMG and S 63 AMG 4MATIC. Standard for S 65 AMG. ⁴ Optional extra. Standard for S 600 and S 65 AMG. ⁵ Only in conjunction with Exclusive package.



From the very first glance, the crystal grey/seashell grey colour scheme is characterised by simple elegance. The light-coloured trim in designo metallised ash wood and the elaborate pattern on the nappa leather seats are all touched by the breath of luxury. Even the steering wheel and centre console are in light-coloured leather, thereby stopping, along with the seats, the onslaught of heat and making the new S-Class an optimal business saloon, even on days of high summer.

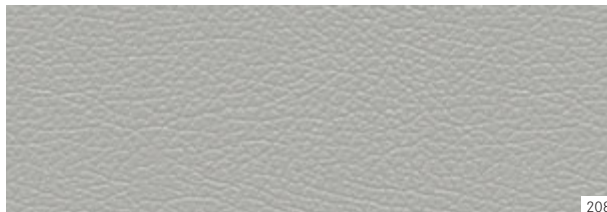

208

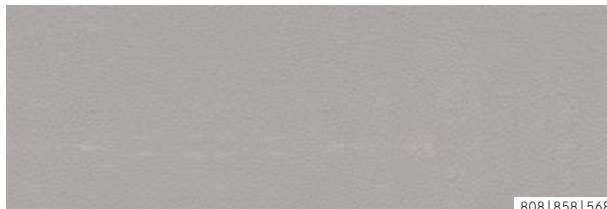

808 | 858 | 568



734



731



729



727



H06



H10



H21

Kristallgrau/Muschelgrau

208 Leather

808 Nappa leather

858 AMG nappa leather¹ | 568 AMG Exclusive nappa leather²

Zierelemente

734 High-gloss dark brown eucalyptus wood

731 High-gloss brown burr walnut wood³729 High-gloss black poplar wood⁴727 designo high-gloss sunburst brown myrtle wood⁴H06 designo metallised ash wood⁴H10 AMG carbon fibre/designo piano lacquer in black^{4, 5}H21 designo piano lacquer^{4, 5}

¹ Only for S 63 AMG and S 63 AMG 4MATIC. ² Only for S 63 AMG, S 63 AMG 4MATIC and S 65 AMG. ³ Optional extra only for S 63 AMG and S 63 AMG 4MATIC. Standard for S 65 AMG. ⁴ Optional extra. ⁵ Only in conjunction with Exclusive package.



The nut brown/black colour scheme is expressive and noble. The interior can be upholstered in leather, nappa leather or Exclusive nappa leather. The armrests of the centre console are optionally covered in nappa leather, the wood trim here is in high-gloss dark brown eucalyptus, the roof lining in black.

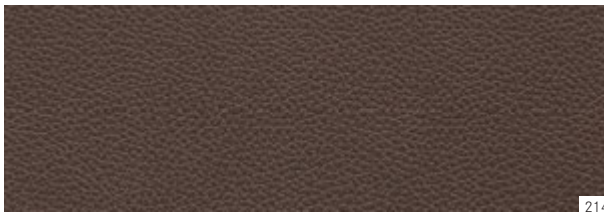

214



814|514|864|584



734



731



729



727



H10



H21

nut brown/black

- 214 Leather
 - 814 Nappa leather | 514 Exclusive nappa leather¹
 - 864 AMG nappa leather² | 584 AMG Exclusive nappa leather³
-

Trim

- 734 High-gloss dark brown eucalyptus wood
 - 731 High-gloss brown burr walnut wood⁴
 - 729 High-gloss black poplar wood¹
 - 727 designo high-gloss sunburst brown myrtle wood¹
 - H10 AMG carbon fibre/designo piano lacquer in black^{1,5}
 - H21 designo piano lacquer^{1,5}
-

¹ Optional extra. ² Only for S 63 AMG and S 63 AMG 4MATIC. ³ Optional extra only for S 63 AMG and S 63 AMG 4MATIC. Standard for S 65 AMG. ⁴ Optional extra. Standard for S 600 and S 65 AMG. ⁵ Only in conjunction with Exclusive package.



This interior is the embodiment of modernity and expressiveness. The fabric roof lining, footwells and centre console have been kept in black and contrast with the seats in porcelain Exclusive nappa leather with a diamond-patterned design, contrasting topstitching and piping. The same leather is used for the armrests on the centre console. High-gloss brown myrtle wood trim blends organically into the scheme.



515|865|585



731



729



727



H06



H10



H21

porcelain/black

515 Exclusive nappa leather¹865 AMG nappa leather² | 585 AMG Exclusive nappa leather³

Trim

731 High-gloss brown burr walnut wood⁴729 High-gloss black poplar wood¹727 designo high-gloss sunburst brown myrtle wood¹H06 designo metallised ash wood¹H10 AMG carbon fibre/designo piano lacquer in black^{1,5}H21 designo piano lacquer^{1,5}

¹ Optional extra. ² Only for S 63 AMG and S 63 AMG 4MATIC. ³ Optional extra only for S 63 AMG and S 63 AMG 4MATIC. Standard for S 65 AMG. ⁴ Optional extra. Standard for S 600 and S 65 AMG. ⁵ Only in conjunction with Exclusive package.

designo.



The colouring of the designo Exclusive nappa leather upholstery emphasises the luxury positioning of the S-Class. Further designo appointments options and information can be found in the price list or at www.mercedes-benz.com/designo

For a maritime-style ambience, there are appointments in designo deep-sea blue/silk beige^{1, 2, 3}, which are available exclusively for the Edition 1. The diamond-design seats with contrasting topstitching and piping are finished in nappa leather in deep-sea blue. The centre console, dashboard, doors and roof lining in silk beige form an aesthetic contrast to the dark leather. The trim in high-gloss sunburst brown myrtle⁴ brings to mind high-quality musical instruments.



502



727

deep-sea blue/silk beige^{1, 2, 3}

502 designo Exclusive nappa leather

Trim

727 designo high-gloss sunburst brown myrtle wood⁴

¹ Only in conjunction with Exclusive package.

² Only in conjunction with Edition 1.

³ Not available for S 63 AMG.

⁴ Optional extra.



The designo Exclusive leather in semi-aniline silk beige/ titanium grey pearl lends the interior a timeless, sophisticated feel. In the seats, the designo diamonds embedded across the entire width of the seat centre panel in combination with upholstery buttons and elegantly integrated Budapest piping further adds to the quality look of the seats. The quilted diamond design of the seats can also be seen in the centre section of the dashboard and in the armrests of the front centre console. If the First-Class seats (224) are specified, it also appears in the rear centre console. The exclusive designo velour floor mats bordered in nappa leather are embellished with designo badges.

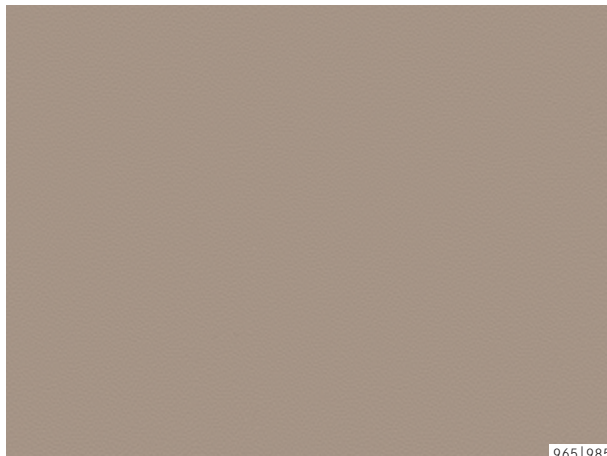

965|985



731



729



727



H10



H21

silk beige/titanium grey pearl

965 designo Exclusive semi-aniline leather

985 designo AMG Exclusive nappa leather

Trim

731 High-gloss brown burr walnut wood

729 High-gloss black poplar wood

727 designo high-gloss sunburst brown myrtle wood

H10 AMG carbon fibre/piano lacquer in black

H21 designo piano lacquer in black



The designo Exclusive semi-aniline leather upholstery in silk beige/satin red pearl lends the car an expressively elegant ambience. The package includes the same extensive features as the semi-aniline silk beige/titanium grey pearl variant.

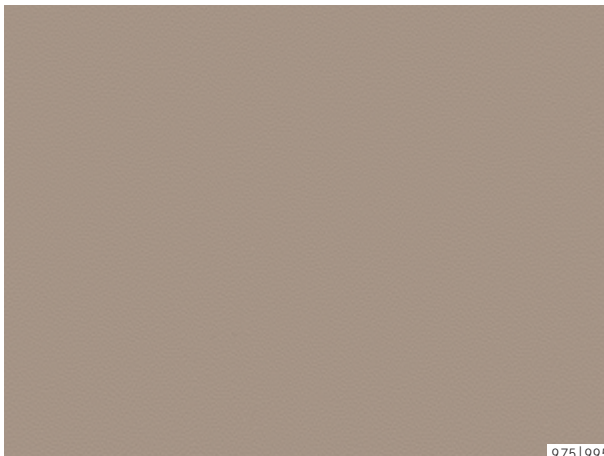

975|995



731



729



727



H10



H21

silk beige/satin red pearl

- 975 designo Exclusive semi-aniline leather
 - 995 designo AMG Exclusive nappa leather
-

Trim

- 731 High-gloss brown burr walnut wood
 - 729 High-gloss black poplar wood
 - 727 designo high-gloss sunburst brown myrtle wood
 - H10 AMG carbon fibre/piano lacquer in black
 - H21 designo piano lacquer in black
-

Wheels.



9-spoke light-alloy wheels painted in tremolite metallic with a high-sheen finish, with 245/55 R 17 tyres (Code 09R).



10-spoke light-alloy wheels painted in vanadium silver, with 245/50 R 18 tyres (Code R41).



5-twin-spoke light-alloy wheels painted in Himalayas grey with a high-sheen finish, with 245/45 R 19 front and 275/40 R 19 rear tyres (Code R17).



Multi-spoke light-alloy wheels painted in titanium silver, with 245/40 R 20 front and 275/35 R 20 rear tyres (Code 13R).



Multi-spoke light-alloy wheels painted in vanadium silver, with 245/55 R 17 tyres (Code 08R).



Multi-spoke light-alloy wheels painted in vanadium silver, with 245/45 R 19 front and 275/40 R 19 rear tyres (Code 11R).



7-triple-spoke light-alloy wheels painted in vanadium silver, with 245/45 R 19 front and 275/40 R 19 rear tyres (Code 12R).



5-spoke light-alloy wheels painted in thulium silver, with 245/40 R 20 front and 275/35 R 20 rear tyres (ex-factory accessory wheels, Code 53R).

AMG wheels.



AMG 5-twin-spoke light-alloy wheels, painted titanium grey with high-sheen finish, with 245/45 R 19 front and 275/40 R 19 rear tyres (standard for AMG Line, Code 793).



AMG multi-spoke light-alloy wheels, painted titanium grey with high-sheen finish, with 245/40 R 20 front and 275/35 R 20 rear tyres (Code 769).



AMG 10-spoke forged wheels, painted titanium grey and polished, with 255/45 R 19 front and 285/40 R 19 rear tyres (standard for S 63 AMG and S 63 AMG 4MATIC, Code 788).



AMG 10-spoke forged wheels, painted matt black, rim flange with high-sheen finish, with 255/40 R 20 front and 285/35 R 20 rear tyres (only for S 63 AMG, S 63 AMG 4MATIC and S 65 AMG, Code 648).



AMG multi-spoke light-alloy wheels, painted high-gloss black with a high-sheen finish, with 245/40 R 20 front and 275/35 R 20 rear tyres (Code 789).



AMG 5-twin-spoke forged wheels, painted titanium grey with high-sheen finish, with 255/40 R 20 front and 285/35 R 20 rear tyres (only for S 63 AMG, S 63 AMG 4MATIC and S 65 AMG, Code 753).



AMG 10-spoke forged wheels, painted titanium grey and polished, with 255/40 R 20 front and 285/35 R 20 rear tyres (only for S 63 AMG, S 63 AMG 4MATIC and S 65 AMG, Code 647).



AMG multi-spoke forged wheels, with ceramic high-gloss polish finish, with 255/40 R 20 front and 285/35 R 20 rear tyres (only for S 65 AMG, Code 696).

Genuine accessories.

A Mercedes-Benz is more than just a car. It can be a travel companion, an office, a living space. And this diversity is reflected in the Mercedes-Benz genuine accessories range.
→ www.mercedes-benz-accessories.com

Enjoy your travels even more – that’s the motto of the Mercedes-Benz genuine accessories programme for the new S-Class. Four scents are offered for the optional AIR-BALANCE package, which will ensure a pleasant atmosphere in the interior. The distinctive rear spoiler and 19-inch 5-spoke light-alloy wheels¹ in high-shine tremolite metallic, with 245/45 R 19 front tyres and

275/40 R 19 rear tyres are available to make an even more striking entrance – their design is a real eyecatcher, and not just when stationary. To transport all you need for your leisure activities you need a convenient carrier system. The New Alustyle basic rack is a flexible option for transporting sports equipment and items of luggage, for example. Combine the basic rack with a range of different roof

attachments, such as the “Comfort” ski and snowboard rack. This offers space for up to six pairs of skis or four snowboards. Its practical pull-out function facilitates loading and unloading.



The four scents in the AIR-BALANCE package sweeten the air in the new S-Class.



19-inch 5-spoke light-alloy wheels with 245/45 R 19 front tyres and 275/40 R 19 rear tyres.



The practical New Alustyle “Comfort” ski and snowboard rack can carry up to six pairs of skis or four snowboards.

¹ Accessory wheels are supplied without tyres, wheel hub covers or wheel bolts; availability depends on engine and selected equipment; contact your Mercedes-Benz dealer for more information.



Services.

Mercedes-Benz Financial Services. Our sophisticated leasing and financing products are tailored to your individual financial needs, giving you the opportunity to drive your dream car while staying financially flexible. Once you have chosen a model, you can enjoy the peace of mind of knowing that both the vehicle itself and our insurance products will keep you particularly well protected. What's more, our range of service products is designed to ensure that your car stays in top shape while offering transparent, manageable conditions. For further details, speak to your Mercedes-Benz dealer, who will be glad to go through the latest financial services and terms and conditions with you.

Test drive. The unique feeling of driving a Mercedes cannot be put into words. We'd like to invite you to experience it for yourself – take a test drive and find out first hand how it feels to drive your dream car. Your nearest authorised Mercedes-Benz dealer is looking forward to your call.

Mercedes-Benz mobility. Your new car comes complete with the promise of feeling safe on the road, but if you should ever need assistance, then Mercedes-Benz Service24h is there to help. Just call the freephone service hotline on 00800 1 777 7777¹. The newly integrated telematics service, Mercedes-Benz Contact², is even more customer friendly: a touch of a button is all it takes to contact the Mercedes-Benz customer centre. If you wish, the relevant vehicle- and position-related data can be transmitted at the same time, thereby allowing the centre to react quickly and provide rapid on-the-spot assistance. Also standard with your new car at no extra charge is the Mercedes-Benz Mobilo³ mobility package. Whether you have lost your key, had a breakdown which cannot be repaired immediately or suffered damage to the vehicle due to an accident or vandalism, Mobilo is there to help you reach your destination – anywhere in Europe.

Mercedes-Benz Museum. Discover what has been moving the world for over 125 years, and embark on a fascinating journey through automotive history in the Mercedes-Benz Museum. More than 1500 exhibits covering an area of 16,500 square metres chart the unique heritage and innovative flair of the inventor of the motor car. You will find one automotive legend after another awaiting you: unique exhibits such as the oldest Mercedes still in existence from 1902, supercharged cars or the awe-inspiring gull-wings. The museum is a spectacular sight in its own right too, thanks to an architecture that breaks away from traditional concepts and creates an unprecedented sense of space. Welcome to the Mercedes-Benz Museum – a world of innovation. www.mercedes-benz-classic.com/museum.



¹ Alternative: +49 69 95 30 72 77. ² Requires a factory-fitted radio, connected to an operational mobile phone. The only charge incurred is the cost of the mobile phone call to the landline network. ³ Once the mobility guarantee has expired (four years), Mobilo can be extended to provide cover in the event of breakdown and insurance claims one year at a time for a maximum of 30 years, provided that regular maintenance is carried out by your Mercedes-Benz service partner.

Interactive Owner's Manual, Mercedes-Benz Guides and Digital Owner's Manual. The website also offers an interactive tour, enabling you to acquaint yourself with your dream car. You can view key functions in detail, gain an insight into the car's inner workings or look at the benefits of each model. For further details, go to your national website. The "Mercedes-Benz Guides" app lets you explore the highlights of the individual models both online and offline. The app is available free of charge from the Apple® iTunes® Store (iOS) as well as the Google Play store (Android). Using the Digital Owner's Manual, information can also be conveniently called up in the vehicle itself via the central display (depending on the model series).

Mobile internet. The entire world of Mercedes-Benz can be accessed at any time with your web-capable mobile device – including specially adapted content for both smartphones and tablets. As well as an overview of all the passenger car models, there are insights into the entire brand world along with a wealth of entertainment offers and direct links to our range of services at www.mercedes-benz.com

Mercedes-Benz ServiceContracts. You need never worry about unexpected workshop costs⁴ again: depending on the specific contract, a Mercedes-Benz ServiceContract can cover unforeseen repairs, maintenance or wear parts. As a result, your vehicle stays in great condition – thanks to the Mercedes-Benz quality you can expect from our highly qualified workshop specialists and Mercedes-Benz genuine parts. Your Mercedes-Benz dealer will be pleased to tell you more about the available service contracts and terms and conditions.

Accident repairs. Should the worst happen and you find yourself in need of repairs, with Mercedes-Benz accident repairs you will receive the right assistance for your

vehicle and ensure that its high-quality safety features are properly maintained. Whether you need paint, body or glass repair work carried out, the highly trained specialists at your Mercedes-Benz service partner will repair your Mercedes-Benz and get you quickly back on the road again. Further information is available from your authorised Mercedes-Benz dealer.



⁴ In accordance with the terms and conditions of the Mercedes-Benz ServiceContracts.

Dimensions.

S-Class

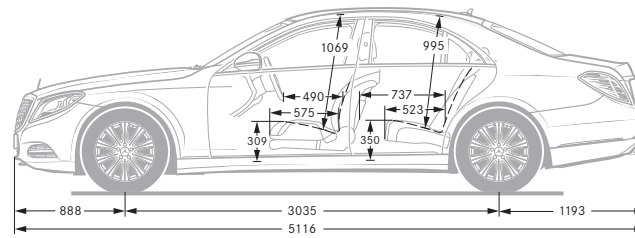
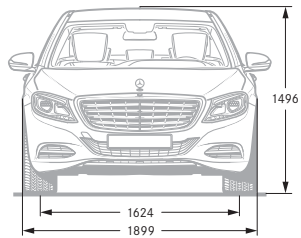

Long-wheelbase S-Class

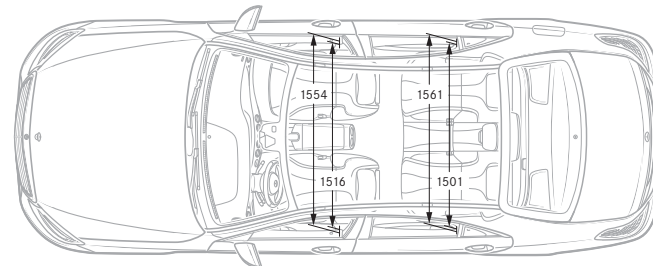
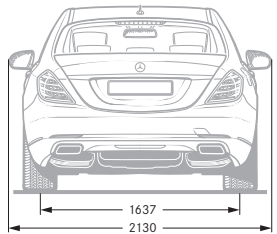
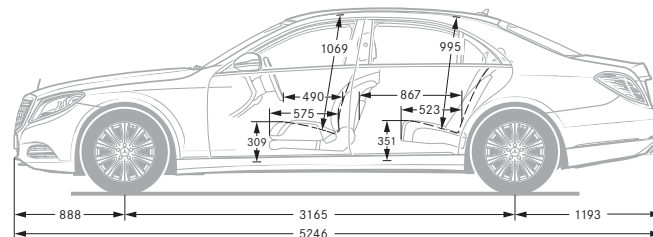
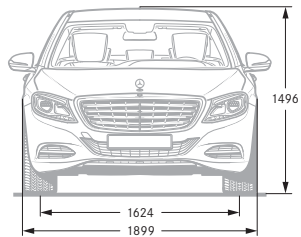

All measurements in millimetres. The dimensions shown are mean values and apply to standard-specification, unladen vehicles.

Paintwork.

The paint system developed by Mercedes-Benz includes one of the best clear coats on the automotive market and is a key factor behind the car's excellent value retention. Its secret is the exceptionally thick molecular structure, which makes the metallic or non-metallic clear coat more resistant and produces a longer lasting and visibly more intensive shine.

Non-metallic paint

040 black

Metallic paints¹

183 magnetite black
 197 obsidian black
 474 peridot brown
 775 iridium silver
 792 palladium silver
 890 cavansite blue
 897 ruby black
 988 diamond silver
 998 anthracite blue

designo paint¹

799 designo diamond white bright

designo manufaktur paints¹

033 designo mocha black metallic
 044 designo magno allanite grey
 049 designo magno cashmere white

¹ Optional extra.

Technical data.

	Diesel engine		Petrol engines	
	S 350 BlueTEC	S 350 BlueTEC 4MATIC	S 500	S 500 4MATIC
Arrangement/number of cylinders	V6	V6	V8	V8
Total displacement in cc	2987	2987	4663	4663
Rated output ¹ in kW (hp) at rpm	190 (258)/3600	190 (258)/3600	335 (455)/5250-5500	335 (455)/5250-5500
Rated torque ¹ in Nm at rpm	620/1600-2400	620/1600-2400	700/1800-3500	700/1800-3500
Transmission	7G-TRONIC PLUS	7G-TRONIC PLUS	7G-TRONIC PLUS	7G-TRONIC PLUS
Acceleration from 0-100 km/h (s) [long-wheelbase version]	6.8 [6.8]	6.8 [6.8]	4.8 [4.8]	4.8 [4.8]
Top speed approx. in km/h [long-wheelbase version]	250 ² [250 ²]	250 ² [250 ²]	250 ² [250 ²]	250 ² [250 ²]
Tyre size	245/55 R 17	245/55 R 17	245/50 R 18	245/50 R 18
Fuel consumption ³ in l/100 km				
Urban [long-wheelbase version]	7.3-7.0 [7.4-7.1]	7.7-7.4 [7.7-7.4]	12.8-12.1 [12.8-12.1]	13.3-12.8 [13.3-12.8]
Extra-urban [long-wheelbase version]	5.1-4.7 [5.2-4.8]	5.6-5.1 [5.6-5.1]	7.1-6.4 [7.1-6.4]	7.5-6.9 [7.5-6.9]
Combined [long-wheelbase version]	5.9-5.5 [6.0-5.6]	6.4-5.9 [6.4-5.9]	9.1-8.6 [9.1-8.6]	9.6-9.1 [9.6-9.1]
Combined CO ₂ emissions ³ in g/km [long-wheelbase version]	155-146 [158-148]	168-156 [168-156]	213-199 [213-199]	225-211 [225-211]
Emissions class [long-wheelbase version] ⁴	Euro 6 [Euro 6]	Euro 6 [Euro 6]	Euro 6 [Euro 6]	Euro 6 [Euro 6]
Efficiency class ([long-wheelbase version]	A [A]	A [A]	D [D]	D [D]
Tank capacity in l/of which reserve, approx.	70/8.0	70/8.0	80/8.0	80/8.0
Boot capacity in l	510	510	530	530
Turning circle diameter in m [long-wheelbase version]	11.9 [12.3]	11.9 [12.3]	11.9 [12.3]	11.9 [12.3]
Kerb weight ⁵ /perm. GVW in kg [long-wheelbase version]	1955/2655 [1975/2690]	2025/2715 [2045/2750]	1995/2695 [2015/2730]	2050/2715 [2070/2750]
Perm. towing capacity (kg) braked/unbraked [long-wheelbase version]	2100/750 [2100/750]	2100/750 [2100/750]	2100/750 [2100/750]	2100/750 [2100/750]

¹ Figures in accordance with Directive 80/1269/EEC in the currently applicable version. ² Electronically governed. ³ The figures shown were obtained in accordance with the prescribed measuring process (Directive [EC] 715/2007 in the currently applicable version). The figures are not based on an individual model and do not constitute part of the product offer; they are provided solely for purposes of comparison between the different vehicle models. ⁴ Data applicable within the European Union only.

Petrol engines

S 600	S 63 AMG	S 63 AMG 4MATIC	S 65 AMG
V12	V8	V8	V12
5980	5461	5461	5980
390 (530)/4900-5300	430 (585)/5500	430 (585)/5500	463 (630)/4800-5400
830/1900-4000	900/2250-3750	900/2250-3750	1000/2300-4300
7G-TRONIC PLUS	AMG SPEEDSHIFT MCT 7-speed sports transmission	AMG SPEEDSHIFT MCT 7-speed sports transmission	AMG SPEEDSHIFT MCT 7-speed sports transmission
- [4.6]	4.4 [-]	- [4.0]	- [4.3]
- [250 ²]	250 ² [-]	- [250 ²]	- [250 ²]
245/45 R 19 front axle, 275/40 R 19 rear axle	255/45 ZR 19 front axle, 285/40 ZR 19 rear axle	255/45 ZR 19 front axle, 285/40 ZR 19 rear axle	255/40 ZR 20 front axle, 285/35 ZR 20 rear axle
- [16.4]	13.8-13.8 [-]	- [14.1-14.1]	- [17.1-17.1]
- [8.4]	7.9-7.9 [-]	- [8.1-8.1]	- [8.6-8.6]
- [11.3]	10.1-10.1 [-]	- [10.3-10.3]	- [11.9-11.9]
- [264]	237-237 [-]	- [242-242]	- [279-279]
- [Euro 6]	Euro 6 [-]	- [Euro 6]	- [Euro 6]
- [F]	E [-]	- [F]	- [F]
80/8.0	70/10.0	70/10.0	80/12.0
500	510	510	510
- [12.3]	11.9 [-]	- [12.3]	- [12.3]
- [2185/2740]	2045/2700 [-]	- [2070/2725]	- [2250/2750]
- [-]	- [-]	- [-]	- [-]

Alternative drive systems

S 300 BlueTEC HYBRID	S 400 HYBRID
4 in-line	V6
2143	3498
150 (204) + 20 (27)/3800	225 (306) + 20 (27)/6500
500 + 250/1600-1800	370 + 250/3500-5250
7G-TRONIC PLUS	7G-TRONIC PLUS
7.6 [7.6]	6.8 [6.8]
240 [240]	250 ² [250 ²]
245/55 R 17	245/55 R 17
4.8-4.7 [4.8-4.7]	7.4-6.6 [7.4-6.6]
4.6-4.3 [4.6-4.3]	6.5-6.1 [6.5-6.1]
4.7-4.4 [4.7-4.4]	6.8-6.3 [6.8-6.3]
124-115 [124-115]	159-147 [159-147]
Euro 6 [Euro 6]	Euro 6 [Euro 6]
A+ [A+]	A [A]
70/8.0	70/8.0
510	510
11.9 [12.3]	11.9 [12.3]
2015/2715 [2035/2750]	1925/2595 [1945/2630]
- [-]	- [-]

² Figures according to Directive 92/21/EC, version 95/48/EC (kerb weight with fuel tank 90% full, driver, 68 kg, and luggage, 7 kg) for standard-specification vehicles. Optional extras and accessories will generally increase this figure and reduce the payload capacity accordingly. Further technical data can be found at www.mercedes-benz.com

Non-metallic paint

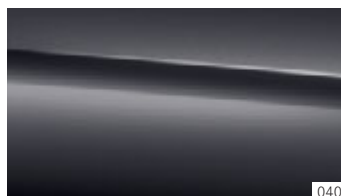

Metallic paints¹

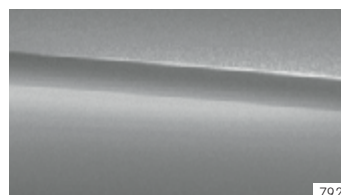
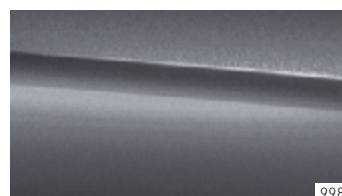
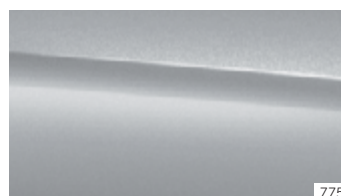
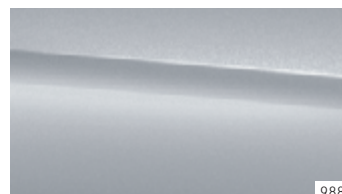
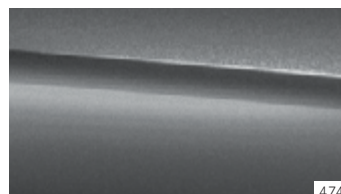
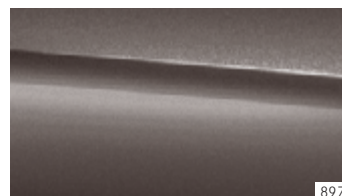
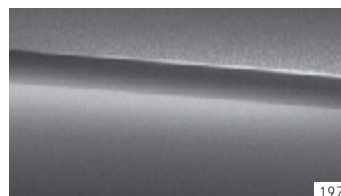
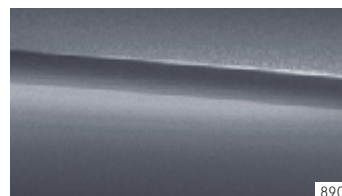
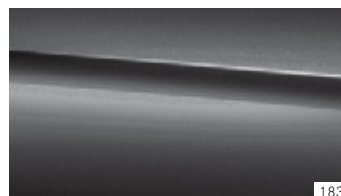

designo paint¹



designo manufaktur paints¹

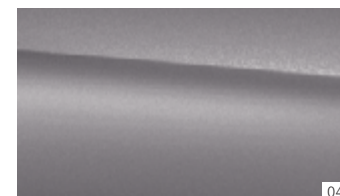
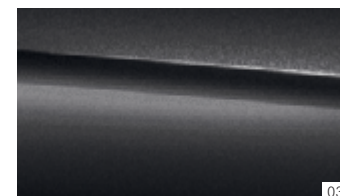

Take-back of end-of-life vehicles. At the end of its long life, you can return your S-Class to us for environment-friendly disposal in accordance with the European Union (EU) End-Of-Life Vehicle Directive. But that day lies a long way off.

A network of vehicle take-back depots and dismantlers has been established to make it as easy as possible for you to return your vehicle. You can leave it at any of these points free of charge and, by doing so, make an important contribution to completing the recycling process and conserving resources.

For further information about the recycling and disposal of end-of-life vehicles and take-back conditions, please visit your national Mercedes-Benz website.

Please note: changes may have been made to the product since this brochure went to press (10.09.2013). The manufacturer reserves the right during the delivery period to make changes to the design, form, colour or specification, provided these changes, while taking into account the interests of the vendor, can be deemed reasonable with respect to the purchaser. Where the vendor or the manufacturer uses symbols or numbers to describe an order or the subject of an order, no rights may be derived solely from these. The illustrations may include accessories and optional extras which do not form part of the standard specification. Actual colours may differ slightly from those shown owing to the limitations of the printing process. This brochure is distributed internationally. It provides a general indication of the range of models, features, optional extras, colours and/or services available in various countries. Some of the models, features, optional extras, colours and/or services shown may not be available in your country or may only be available in a different specification. Additionally some models, features, optional extras, colours and/or services may only be available in combination with others. For current and more specific information in relation to the range of models, features, optional extras, colours and/or services available in your country, and their pricing, you should contact your nearest authorised Mercedes-Benz Passenger Car Dealer.

www.mercedes-benz.com