

OUTLANDER



love that car



LOVE THAT CAR. HERE AT MITSUBISHI, WE LOVE OUR VEHICLES.
WE LOVE THEIR SUPERIOR QUALITY, WHAT THEY STAND FOR,
AND *WHAT THEY'RE CAPABLE OF.*

AND WE WANT YOU TO FEEL THE SAME WAY. IT'S WHY WE STRIVE FOR THE HIGHEST STANDARDS IN EVERYTHING WE DO, AND IT'S WHY WE BACK ALL
OUR VEHICLES WITH OUR MITSUBISHI DIAMOND ADVANTAGE, AUSTRALIA'S BEST NEW CAR WARRANTY, CAPPED PRICE SERVICING AND CUSTOMER CARE.



OUR PROMISE

When you buy a Mitsubishi Outlander, or any vehicle from our range, you're buying a vehicle that's backed by world-class research, technical innovation, and leading performance. In every area of our business, we're continually focussed on four key values. By following these values, we never fail to create superior vehicles that people love.

STREET PRESENCE



We design attention grabbing vehicles with real street presence. We're focussed on delivering vehicle design that not only defines the best in innovation but embodies the essence of genuine performance, handling dynamics and absolute driving pleasure.

ADVANCED TECHNOLOGY



We'll continue to develop ground-breaking technology that focuses on better control, performance and lifestyle. This includes innovations such as our MIVEC engine technology, our INVECS Smart Logic transmission system and our leading Mitsubishi Multi Communication System.

DRIVER CONFIDENCE



We're committed to raising the bar in terms of safety. Outlander delivers with the Mitsubishi All Terrain Technology (MATT™) package and Super All Wheel Control (S-AWC) on V6 models providing advanced control, traction and stability systems for the peace of mind of all occupants.

SUPERIOR VALUE



We'll constantly strive to deliver the ultimate customer experience at all times. This is reflected by the Mitsubishi Diamond Advantage, Australia's best new car warranty, capped price servicing and customer care, by our feature-packed vehicles, and our ongoing commitment to making our vehicles more cost effective and fuel efficient.



Whether you're heading out of town for the weekend, driving to the gym, beach, footy-field, or simply running errands about town, the Outlander delivers the comfort, space, versatility and safety you need to get through an active day.

The Outlander is also 4WD capable – making it great for weekend adventures that might be off the beaten track. Mitsubishi's advanced technology systems means Outlander delivers the ultimate in performance, control and safety. Outlander is also available in a 2WD model.

Outside, Outlander has a sporty look with alloy wheels, chrome trim and high definition headlamps – and practical features like roof rails and an easy to load split tailgate. Combined with Smart Key and Bluetooth® technology inside, Outlander infuses style and practicality into one.

So whatever your active life, the Mitsubishi Outlander has the style, versatility and clever technology to make it truly easy.

THE
MITSUBISHI OUTLANDER
HAS EVERYTHING
YOU **NEED** *TO GET UP*
AND GO
WHEREVER YOUR DAY TAKES YOU.



Whether you're zipping around town, or heading away with friends for the weekend, Outlander will always deliver the ultimate in interior comfort and style.

The seats have been designed with ergonomics in mind, so you and your passengers can stay comfortable how ever long the journey. The leather front seats are even heated, which is ideal for those cold winter early morning starts. Add to this the availability of a leather look dash and door trim to give you a premium interior feel.

Inside, there is plenty of room for you and all of your passengers and luggage.

As the driver, you also benefit from innovation at your finger tips including the Mitsubishi Multi Communication System (MMCS) which controls a raft of features including GPS as well as displaying useful vehicle information. Cruise control will help you relax on the open road, and audio controls mounted on the leather steering-wheel mean setting the track to your active life couldn't be easier.

ENJOY TAKING ON *LIFE*
WITH THE HELP OF THE OUTLANDER'S
STYLISH INTERIOR
AND ADVANCED TECHNOLOGY.





Updated for 2015



PASSENGER



EQUIPPED WITH
 SUPERIOR ENGINE TECHNOLOGY HELPING YOU
STAY IN CONTROL,
 NO MATTER WHAT THE CONDITIONS OUTSIDE.
 WITH THE CHOICE OF TWO POWERFUL AND
 EXTREMELY FUEL-EFFICIENT MIVEC ENGINES
 YOU CAN ENJOY EXCELLENT
**FUEL EFFICIENCY,
 LOW EMISSIONS,**
 WITHOUT COMPROMISING ON
DRIVABILITY OR POWER.

MIVEC ENGINES

With Mitsubishi's MIVEC Engine technology (Mitsubishi Innovative Valve timing Electronic Control) Outlander has a lighter engine with intelligent valve timing technology. This delivers fuel efficiency and lower emissions, yet still provides excellent driveability and towing power. It minimises fuel consumption at lower revs while increasing airflow at high revs for greater power and performance.



2.4L MIVEC ENGINE

Choose the 2.4 litre 4 cylinder MIVEC engine for economical performance.

- 125kW of power
- 226Nm of torque
- 5 speed manual or CVT automatic

CONTINUOUSLY VARIABLE TRANSMISSION (CVT)

CVT offers infinitely variable gear ratios that allow the engine to always operate at optimum RPM, irrespective of the vehicle's speed. This maximises power and economy helping to ensure a smooth, stable ride with seamless gear changes.

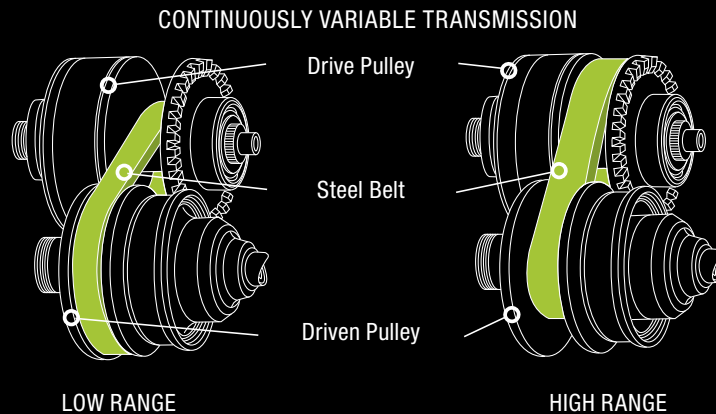

3.0L V6 MIVEC ENGINE

Choose the powerful 3.0 litre V6 MIVEC engine for superior performance.

- 169kW of power
- 291Nm of torque
- 6 speed automatic with Smart Logic

SMART LOGIC

The Smart Logic transmission system learns and adapts to each driver's preferences by recording engine and foot brake data. The control logic then adapts the gearshift timing to suit your style. This means it adapts to your driving style.

ADAPTIVE SHIFT CONTROL DURING ACCELERATION



ADAPTIVE SHIFT CONTROL GOING DOWNHILL

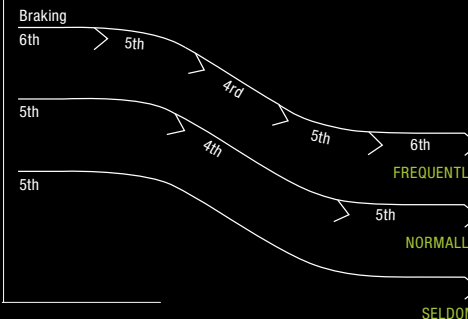

SPORTS MODE AUTOMATIC TRANSMISSION

Available across both engines, Sports Mode means you can switch between the ease of an automatic and CVT auto or enjoy the control of a manual without a clutch. The clutch free operation reduces the rev and torque loss usually associated with engaging gears, meaning you can maintain momentum in off-road situations.

COMPARISON OF SHIFT RESPONSE

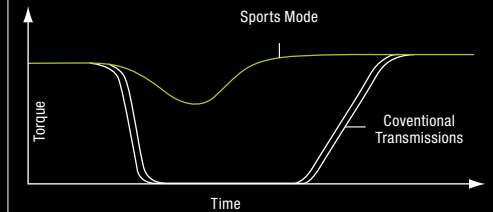

Available on both engines

PADDLE SHIFTS

When the gear shift is in Sports Mode position, paddles on the Outlander steering wheel allow you to make lightning quick gear changes without your hands leaving the wheel.



Mitsubishi Outlander 4WD brings you the latest in superior safety and four wheel drive technology. Outlander boasts MATT™ (Mitsubishi All Terrain Technology). A sophisticated combination of many four wheel drive and safety systems, designed to work together to deliver you the versatility and peace of mind to enjoy all an active life offers. Whether it's within the hustle and bustle of the city or enjoying the freedom of a weekend escape Outlander has the whole package.

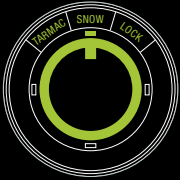

SUPER ALL WHEEL CONTROL (S-AWC)

The constant All Wheel Drive V6 comes with the S-AWC system, which provides greater cornering control, traction and improved stability. S-AWC integrates Active Front Differential, Yaw Rate Feedback Control, Active Stability Control and Anti-lock Braking System to provide optimal handling on all road surfaces. Switch instantly at speeds of up to 100km/h between 'Tarmac' for paved roads, 'Snow' for when roads can become slippery and 'Lock' for steady control on rougher roads.

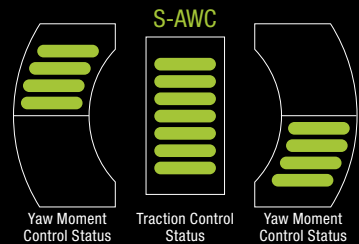

S-AWC DISPLAY

This displays the selected control as well as the status of driving torque control to the right and left front wheels. This is according to left or right hand turning. The status of driving torque to the front and rear wheels is then displayed in the centre of the meter.



ACTIVE FRONT DIFFERENTIAL (AFD)

Using the electronically controlled clutch the AFD limits speed difference and controls driving force distribution between the right and left front wheels. This provides a higher level of cornering and stability performance and enables quicker automatic response for changes in road surfaces.

YAW RATE FEEDBACK CONTROL

Processing driving information this system has an enhanced calculating speed and accuracy to provide optimal control of the front differential and electronically controlled coupling. If unstable vehicle behaviour is detected the system adjusts driving force to four wheels, delivering better stability.



ALL WHEEL CONTROL (AWC)

With the Outlander 2.4 litre 4-cylinder 4WD comes AWC, which allows you to switch instantly at speeds of up to 100km/h between '2WD' for fuel efficiency, '4WD' for increased traction on sandy or gravel roads and 'Lock' for when roads can become unpredictable.

ELECTRONICALLY CONTROLLED COUPLING (ECC)

The ECC within the rear differential distributes driving force to the rear wheels depending on the driving conditions. This automatically increases driving performance.

PEACE OF MIND

EVERY TIME YOU SIT BEHIND THE WHEEL, THE OUTLANDER FEATURES SEVERAL IMPORTANT SAFETY INNOVATIONS TO PROTECT YOU AND YOUR PASSENGERS— IN ADDITION TO MITSUBISHI'S LEADING MATT™ SYSTEM, WHICH ENSURES A STEADY AND STABLE RIDE.

MATT

MITSUBISHI ALL TERRAIN TECHNOLOGY

Mitsubishi's unique 4WD and safety technology.

HSC

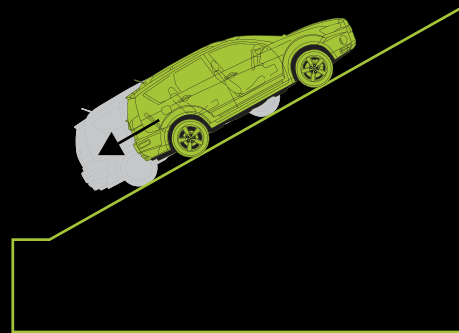

Hill Start Control

This technology makes it easier to start off a steep uphill slope by preventing the vehicle from rolling backwards. It maintains the braking force for two seconds while you move your foot from the brake to the accelerator.

ASC

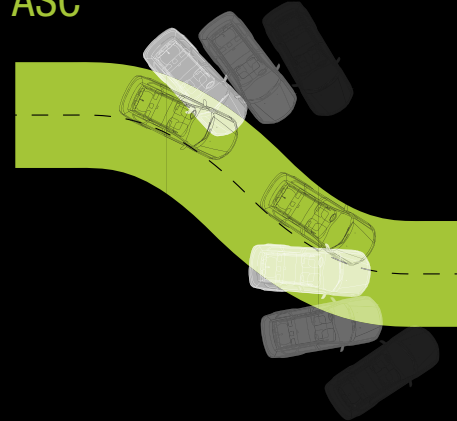

Active Stability Control

Maintains stability and control when cornering, by automatically recognising under-steer and over-steer. It applies brakes to the appropriate wheels to keep you online through corners.

ATC

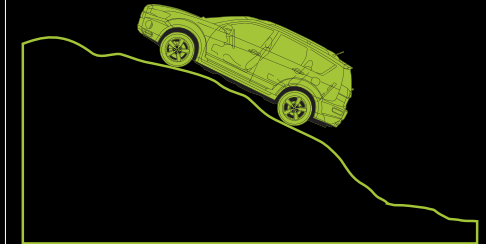

Active Traction Control

Helps you maintain traction on the most slippery or rugged of surfaces. This intelligent system automatically controls the engine output, so driving wheels are prevented from spinning. Sensing loss of traction in an independent wheel, it applies braking force to that wheel and sends extra power and torque to other wheels with traction to keep you moving.

ABS

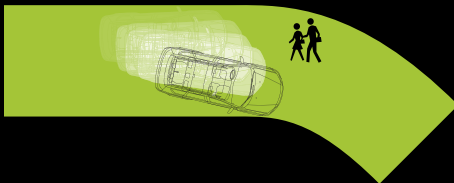

Multi-mode Anti Lock Braking System

This allows you to manoeuvre around objects under heavy braking conditions. Outlander's intelligent 4-channel, 4-sensor braking system works in conjunction with the drive mode to monitor different wheel speeds and activate brakes to individual wheels when required to deliver superior control.

EBD

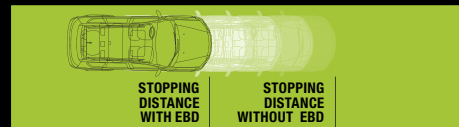

Electronic Brakeforce Distribution

This technology reduces stopping distances by detecting passengers or heavier loads and automatically increases rear-braking force.

HID/AFS



High Intensity Discharge Headlamps with Adaptive Front Lighting System

Clever self levelling HID headlamps offer brighter illumination for night time driving and AFS provides increased illumination of corners when the car is turning.



SRS AIRBAGS

To provide ultimate protection in the event of a frontal collision, the Outlander range is fitted with driver and front passenger Supplementary Restraint System (SRS) airbags, with side and curtain airbags available across the range.

RISE SAFETY

RISE, Mitsubishi's Reinforced Impact Safety Evolution body design system with integrated chassis, is a highly rigid one-piece shell. The super strength cabin will cocoon your family and provide outstanding protection in the event of an accident. The RISE body integrates a rigid ladder frame, side impact bars, and collision absorbing joints to keep you safe. An aluminium roof reduces weight and lowers the centre of gravity for greater stability and better cornering, offering a sedan-like driving experience.



REVERSING CAMERA & REVERSING SENSORS

The MMCS reversing camera supports the driver's rear field of view, automatically appearing on screen when the reverse gear is engaged. In conjunction with the reversing sensors, which alert you when you are getting close to objects, it makes parking in tight spots a breeze. It also offers safety and peace of mind when you are backing in and out of driveways.



DUSK SENSING HEADLAMPS

Help you stay focused on the road at all times. A sensor on the windscreen automatically sends a signal to your lights and they will turn on when it gets dark or when you're travelling through a tunnel.

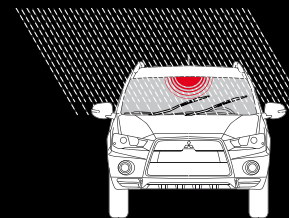
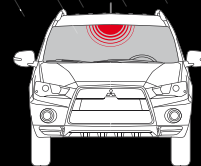
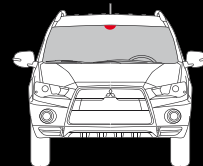
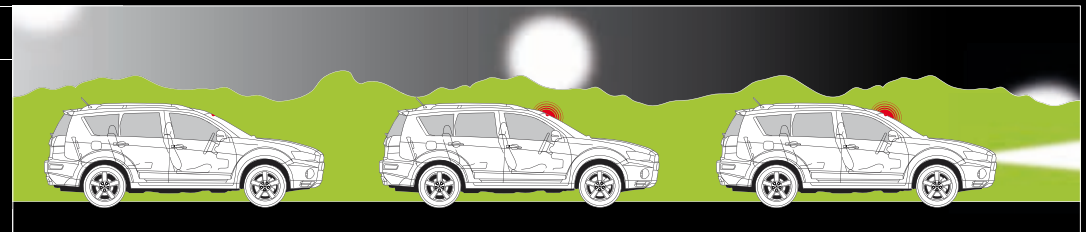

AUTO RAIN SENSING WIPERS

A sensor automatically detects moisture on the windscreen and according to the amount of rain present the system will activate the wipers at the appropriate speed.

FITS WITH YOUR
WAY OF LIFE

WHETHER CARRYING A CAR-FULL OF PEOPLE, CARGO OR BOTH.

IT'S AS BIG ON **INNOVATION**

AS IT IS ON **SPACE.**

SEATS MOVE AND FOLD AWAY EFFORTLESSLY. THE LARGE LUGGAGE SPACE
MEANS BULKY ITEMS GO IN EASILY AND LOADING UP IS A BREEZE.



FLEXIBLE, SMART STORAGE

Clever storage areas throughout the cabin ensure there's plenty of room for everything you could need. It includes a range of smart storage options, including front and rear cup holders, rear underfloor storage, and even a hot-cold thermo box – so you can keep drinks warm or cool.



OVERSEAS MODEL SHOWN

SMART KEY

Smart Key is Mitsubishi's advanced security transmitter, which means completely key-less operation. Thanks to Smart Key, Outlander can recognise the key within a 70cm radius. So, you can lock and unlock the doors, open the tailgate and even start the engine, all whilst the Smart Key is still tucked in your pocket or bag. The days of searching and fumbling for keys are no longer in your new Outlander.

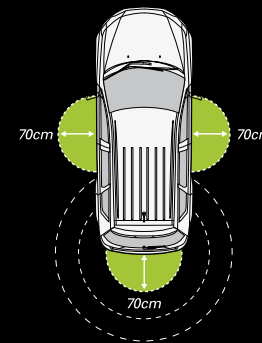

FIT UP TO SEVEN PEOPLE WITH EASE

Outlander offers the option of a third row seat – which means you can comfortably seat up to seven passengers.

EASY LOADING REAR TAILGATE

Loading up just got a whole lot easier. A strong and convenient fold-down tailgate gives a lower load-in height so bulky items fit and slide in more easily.



CREATE MORE SPACE WITH THE TOUCH OF A BUTTON

The Outlander features unique, electronic roll-and-tumble seats – which roll forward to create vast interior storage space. This makes it incredibly easy to throw in items like bikes, prams, surfboards, bulky packages, or luggage - all with the flick of a switch. In fact, once the seats are folded back, there's a massive 1691 litres of storage volume.

At the rear of the Outlander, there is a cargo blind which can add extra security and help you keep precious luggage hidden away when you need it.



PULL THE SWITCH



SEATBACK FALLS FORWARD



SEAT SLIDES FORWARD



SEAT TUMBLES FORWARD



HANDLING IT WITH **STYLE.**

OUTLANDER HAS A RAFT
OF NEXT GENERATION

TECHNOLOGY TO MAKE YOUR ACTIVE LIFESTYLE

MUCH EASIER

FROM HANDS FREE BLUETOOTH® 2.0 MOBILE PHONE OPERATION, SO YOU CAN TALK WITHOUT HAVING TO PULL OVER, USB AND IPOD CONNECTIVITY SO YOU CAN LISTEN TO YOUR FAVOURITE TRACKS AND THE STATE OF THE ART MITSUBISHI MULTI COMMUNICATION SYSTEM (MMCS) THAT ALLOWS YOU TO STAY IN GREATER CONTROL OF YOUR ACTIVE LIFE.

MULTI INFORMATION DISPLAY

The LED Multi Information Display provides handy vehicle information such as fuel consumption, a trip computer and outside temperature functions. You can configure the display to show you exactly the information you want.

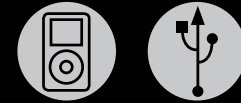

CONNECT YOUR OWN MUSIC

Incorporating the latest technology to make every drive a pleasure, the Outlander is iPod compatible – which means you can connect and charge your iPod/MP3 player. Got your favourite music stored on a USB? The Outlander is USB compatible – so you can connect and play MP3s wherever you like.

MITSUBISHI MULTI COMMUNICATION SYSTEM (MMCS)

MMCS is an integrated communication and media system that provides satellite navigation, audio control, DVD function and a host of other features, controlled via the 7" full colour in dash touch screen. MMCS allows you to customise features such as dusk sensing headlamp sensitivity, wiper speed and room lamp shutdown delay.



VOICE ACTIVATED BLUETOOTH® PHONE CONNECTIVITY

Outlander has the latest hands-free phone system technology, with voice activated Bluetooth® phone connectivity. This allows you to make calls with simple voice commands and receive them at the touch of a button. All this is integrated through the vehicle's audio system, allowing you to stay focused on the road. Bluetooth® 2.0 also allows you to stream songs straight from your compatible mobile.

ROCKFORD FOSGATE® STEREO SYSTEM

Delivering a massive 710 watts with 9-surround sound speakers and integrated 10-inch subwoofer, Outlander has the sound to match its looks.



REAR ENTERTAINMENT DVD SYSTEM

Outlander rear seat passengers can enjoy sophisticated in-car entertainment with their very own 9-inch full colour DVD screen. Games console compatible, it includes one set of infra red cordless headphones. As the passengers watch a DVD, the rest of the car can listen to the music, or simply tune out and take in the surrounding scenery.

MITSUBISHI DIAMOND ADVANTAGE
AUSTRALIA'S

BEST NEW CAR WARRANTY AND CUSTOMER CARE

WHEREVER YOUR ROAD TAKES YOU, WE'LL BE RIGHT THERE WITH YOU.
IT'S PART OF OUR COMMITMENT TO ENSURING YOU ENJOY COMPLETE DRIVING
PLEASURE WHENEVER YOU GET BEHIND THE WHEEL OF YOUR MITSUBISHI.
NOTHING DEMONSTRATES THIS COMMITMENT BETTER THAN OUR
UNIQUE DIAMOND ADVANTAGE
CUSTOMER CARE PACKAGE.

10 | 5
YEAR | YEAR

**MITSUBISHI
DIAMOND
ADVANTAGE**

**AUSTRALIA'S BEST
NEW CAR WARRANTY;
CAPPED PRICE SERVICING
AND CUSTOMER CARE**

WARRANTY 10/5YR	CUSTOMER ASSIST 24/7	SYR ROADSIDE ASSIST	CAPPED PRICE SERVICING	GENUINE SERVICE	GENUINE PARTS	200+ DEALER NETWORK	FINANCE	INSURANCE
Mitsubishi Motors Australia Limited offers a 10 year/160,000km (whichever comes first) non-transferable Powertrain Warranty, a 5 year/130,000km (whichever comes first) New Vehicle Warranty and a 5 year Perforation Corrosion Warranty on all Mitsubishi cars and light commercial vehicles. Service conditions apply. See your dealer for details.	We're here to help, 24 hours a day, seven days a week. So just call Mitsubishi Motors Australia Customer Assistance Centre on 1300 13 12 11 if you have any questions, or for the location of your nearest Mitsubishi Dealer.	Peace of mind is guaranteed anywhere in Australia with our free 5 year/130,000km (whichever comes first) Roadside Assist, 24 hours a day, 365 days a year. Our fast, comprehensive roadside service offers assistance, repairs, towing and storage. Our Premium Roadside Assist clients also enjoy the added benefits of accommodation, medical and transport facilities. Service conditions apply.	Enjoy 'no surprises' certainty when you book your Mitsubishi in for its regular service requirements. Your servicing costs will be capped for the first 4 years or 60,000km of driving, whichever occurs first up to the first four Regular Services and eight Regular Services for Ralliart and Lancer Evolution vehicles. Conditions apply.	Mitsubishi offers one of Australia's best service intervals of 12 months/15,000 km (whichever comes first). Regular scheduled servicing ensures the long-term reliability and safety of your Mitsubishi and our Scheduled Service Program also helps protect your car's resale value.	Your Mitsubishi will be serviced regularly by skilled Mitsubishi-trained technicians. Only genuine Mitsubishi parts are fitted to your car during scheduled servicing – parts that have been fully tested and meet Mitsubishi's stringent quality control. All these parts carry the Mitsubishi Genuine Parts 12 months/20,000 km (whichever comes first) guarantee.	With a network of more than 200 dealers, Mitsubishi is never too far away.	Take the burden out of financing your new Mitsubishi vehicle with our competitive range of finance products, developed by Mitsubishi Motors Australia Limited and St. George Motor Finance Limited.	With the sound backing of Swann Insurance and Mitsubishi Motors Australia Limited, Mitsubishi owners can choose between vehicle and personal protection solutions including motor vehicle, gap cover and loan protection insurance as well as a range of tailored warranty policies.



†10 year or 160,000km Powertrain Warranty (whichever comes first) (non transferable). 5 year or 130,000km New Vehicle Warranty (whichever comes first).
^5 year or 130,000km Roadside Assist (whichever occurs first). Service conditions apply. *4 year or 60,000km Capped Price Servicing (whichever comes first).
Conditions apply. See your Dealer for full details.



mitsubishi-motors.com.au

Specifications and features may vary by model.
Please refer to the Specifications Booklet enclosed
or mitsubishi-motors.com.au for full information.

As features can change without notice, confirm the equipment
level of your vehicle with your Mitsubishi dealer.

OUTLANDER

SPECIFICATIONS & FEATURES



love that car



MITSUBISHI OUTLANDER – KEY FEATURES BY MODEL



LS – 2WD

Mechanical

2.4L 4cyl DOHC 16 valve MIVEC Engine
5 speed manual transmission
Optional Continuously Variable Transmission (CVT auto) with INVECS III Smart Logic and 6 step Sports Mode
Power steering

Exterior

16" Alloy wheels
Body colour door mirrors
Body colour bumper
Rear roof spoiler with high mount stop lamp
Rear mudflaps
Roof rails

Interior

Leather bound steering wheel
Leather bound gearshift
Door trim cloth inserts
Carpet floor covering

Comfort

Air conditioning
Pollen filter
Tilt adjustable steering column
Side and rear window demisters
Driver's foot rest
Passenger assist grips

Convenience

Cruise control
Keyless entry
Power windows front and rear (driver auto up and down)
Power door mirrors
Variable intermittent windscreen wipers
Intermittent rear wiper and washer
Steering wheel audio controls
Accessory power socket (3-cargo, console and instrument panel)
Front map lamps
Cargo area lamp
Interior lamp with time delay
Ignition key cylinder illumination
Door courtesy lamps
Ashtray

Digital clock
Driver and passenger sunvisor with ticket holder and illuminated vanity mirror
High contrast instrument meter
Tachometer
Headlamps on warning

Storage

Glovebox – illuminated and lockable
Upper and lower glovebox
Floor console with storage box and lid
Door pockets – front and rear
Cup holders
Bottle holders in front doors
Coat hook
Seat back pocket – passenger

Cargo tie down hooks (4)
Split tail gate

Seating

Cloth seat trim
Front seats
Bucket seats
Slide and recline adjustment
Driver height adjustment
Height adjustable headrests
Second row seats
60:40 split folding function
Slide and recline adjustment
One touch roll away seats
Centre armrest with cupholders
Height adjustable headrests (3)

Audio & Media

Electronic tune AM/FM radio/CD/MP3 player
6 speakers (includes 2 tweeters)
Audio input jack
USB audio input
Multi information display – includes trip computer, outside temperature, average fuel consumption

Safety

Driver & front passenger SRS airbags
Anti-lock Braking System (ABS)
Electronic Brakeforce Distribution (EBD)
Active Stability Control (ASC)
Active Traction Control (ATC)

Reinforced Impact Safety Evolution (RISE) body
Side door impact beams
3 point Emergency Locking Retractor (ELR) seatbelts (all seating positions)
Auto Locking Retractor (ALR) seatbelts on outbound rear seats
Front seatbelt pretensioners & force limiters
Front seatbelt height adjustable shoulder anchorages
Seatbelt warning lamp – driver & front passenger
Child proof rear door locks
Child restraint anchorage points (3)
Power brake booster with emergency brake assist system

Security

Anti-theft encrypted engine immobiliser
Theft protection alarm
Steering lock
Diamond Advantage roadside assistance – 5 years

Options

Side SRS airbags (driver & front passenger) & curtain SRS airbags

LS – 4WD

(Features Additional to LS – 2WD)

Mechanical

All Wheel Control (AWC)

Comfort

Automatic Air Conditioning

Safety

Side SRS airbags (driver & front passenger) & curtain SRS airbags
Hill Start Control (CVT only)

Options

Third Row seats – CVT only
Front facing reclining bench
Stows under floor
Increasing seating capacity to 7*

*Full size spare is replaced with space saver spare when this option is selected



XLS – 4WD

(Features Additional to LS – 4WD)

Mechanical

Continuously Variable Transmission (CVT)
INVECS III Smart Logic with 6 step Sports Mode
Paddle shifts

Exterior

18" alloy wheels
Chrome grille
Front fog lamps
Chrome exhaust tip
Privacy glass
Headlamp washers
Silver door handles

Interior

Alloy sports pedals
Chrome interior door handles
Leather look dash trim panel and door trim inserts
Dark silver accent panel

Comfort & Convenience

Smart key
Warm and cool box

Seating

Sports cloth seat trim

Audio & Media

In dash 6 CD changer
Bluetooth® hands free phone operation¹
Bluetooth® 2.0 wireless data transfer²

Safety & Security

Reverse parking sensors
Door mirrors with integrated turn indicator
Adaptive Front lighting System (AFS)
High Intensity Discharge (HID) headlamps
Cargo blind
Diamond Advantage premium roadside assistance – 5 years

Luxury Option Pack

Premium 18" VRX style 7 spoke alloy wheels
Chrome: door handles, side sill garnish, side window garnish, rear garnish
Electric sunroof with slide and tilt
Rockford Fosgate® premium 710 watt audio with 9 speakers and 10-inch subwoofer
Rear seat entertainment system with remote control and headphones (1 set)
Mitsubishi Multi Communication System (MMCS)2 – includes satellite navigation
Leather seat facings
Power driver seat
Heated front seats
Seat back pocket – driver
Automatic dusk sensing headlamps
Automatic rain sensing wipers
Reverse camera

VR – 4WD

(Features Additional to LS – 4WD)

Mechanical

3.0L V6 SOHC 24 valve MIVEC Engine
6 speed automatic transmission
INVECS II Smart Logic with Sports Mode
Paddle shifts
Super All Wheel Control (S-AWC) Constant 4WD system
Active centre differential
Front limited slip differential

Exterior

18" alloy wheels
Front fog lamps
Chrome dual exhaust tip
Privacy glass
Silver door handles

Interior

Chrome interior door handles
Alloy sports pedals

Seating

Sports cloth seat trim

Safety

Reverse parking sensors

Security

Cargo blind

VRX – 4WD

(Features Additional to VR)

Exterior

Chrome: door handles, side sill garnish, side window garnish, rear garnish, grille
Headlamp washers
Premium 18" 7 spoke alloy wheels

Interior

Sports steering wheel
Leather look dash trim panel and door trim inserts
Dark silver accent panel
Comfort & Convenience
Electric sunroof with slide and tilt
Smart key
Automatic dusk sensing headlamps
Automatic rain sensing wipers

Storage

Warm and cool box
Seat back pocket – driver

Seating

Leather seat facings
Power driver seat
Heated front seats

Audio & Media

Rockford Fosgate® premium 710 watt audio with 9 speakers and 10-inch subwoofer

Rear seat entertainment system with remote control and headphones (1 set)
Mitsubishi Multi Communication System (MMCS)2 – includes satellite navigation
Bluetooth® hands free phone operation¹

Safety & Security

Door mirrors with integrated turn indicator
High Intensity Discharge (HID) headlamps
Adaptive Front lighting System (AFS)
Reverse camera
Diamond Advantage premium roadside assistance – 5 years

¹Bluetooth® phone connectivity depends on your phone compatibility.

²When MMCS is fitted, USB input, 6 CD changer, and Bluetooth® 2.0 wireless data transfer functionality is deleted. Navigation voice recognition commands replace Bluetooth® voice recognition commands.

OUTLANDER SPECIFICATIONS



Engine	LS/XLS	VR/VRX
Type	2.4L 4cyl DOHC 16 valve MIVEC Engine	3.0L V6 SOHC 24 valve MIVEC Engine
Bore x Stroke	88.0mm x 97.0mm	87.6mm x 82.9mm
Capacity	2,359cm ³	2,998cm ³
Compression Ratio	10.5:1	10.5:1
Maximum Power	125kW @ 6,000rpm	169kW @ 6,250rpm
Maximum Torque	226Nm @ 4,100rpm	291Nm @ 3,750rpm

2.4L MIVEC Engine

3.0L MIVEC V6 Engine

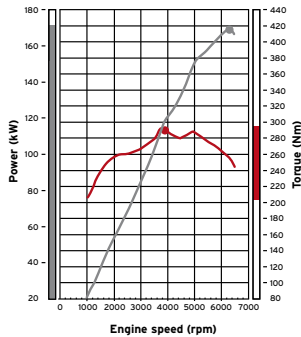
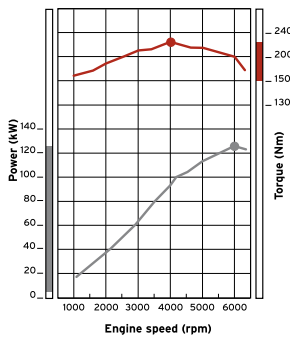

Models	Wheels	Tyres ³
LS	16" x 6.5" JJ Alloy wheels	215/70R16 99H
XLS / VR / VRX	18" x 7" JJ Alloy wheels	225/55R18 97H
All models	Full size spare wheel*	

³The tyres fitted to Outlander as standard equipment are designed primarily for use on sealed roads. If your Outlander is to be driven primarily on unsealed roads, please consult your Mitsubishi dealer for advice on suitable tyre choices.

*Full size spare is replaced with space saver spare when 7 seat option is selected.

Electrical System

Battery	55D23L
Alternator	120 Amp

Four Wheel Power Assisted Brakes	
Front	Ventilated discs
Rear	Solid discs

Suspension	
Front	Independent MacPherson strut coil spring with stabiliser bar
Rear	Independent multi-link coil spring with stabiliser bar

Drive transfer system - 4WD models	
LS/XLS	All Wheel Control
VR/VRX	Super All Wheel Control constant 4WD system (S-AWC)

Transmission	2.4L 4 cyl	2.4L 4 cyl	3.0L V6	3.0L V6
	LS	XLS	VR	VRX
5-speed manual transmission	S	-	-	-
CVT with INVECS 'Smart Logic' and 6 step Sports Mode	0	S	-	-
6 speed automatic transmission with INVECS 'Smart Logic' and Sports Mode	-	-	S	S
Paddle shifts	-	S	S	S

Transmission Ratios	5 Speed Manual Transmission	Continuously Variable Automatic Transmission (CVT) with "Sports Mode" sequential style shift change & INVECS 'Smart Logic'	6 speed automatic transmission with "Sports Mode" sequential style shift
	LS	LS/XLS	VR/VRX
Ratio	-	2.349 - 0.394	-
first	3.538	2.349	4.199
second	1.913	1.517	2.405
third	1.333	1.105	1.583
fourth	1.028	0.857	1.161
fifth	0.820	0.680	0.855
sixth	-	0.394	0.685
reverse	3.583	1.750	3.457
Final Gear Ratio	4.562	6.466	3.571

Fuel System	2.4L Manual	2.4L CVT Auto	3.0L Auto
	2WD / 4WD	2WD / 4WD	4WD
Fuel Consumption [^] (ADR 81/02) litres per 100km	9.2 / 9.5	9.0 / 9.3	10.4
Fuel Tank Capacity (L)	63 / 60	63 / 60	60
Fuel Supply Equipment	Electronically controlled multi-point fuel injection		

[^]These figures are obtained from controlled laboratory tests conducted by Mitsubishi Motors to Australian Design Rule ADR81/02 and are provided to assist you in comparing the fuel consumption of Outlander with other vehicles. The actual fuel consumption you achieve will depend, however, on many factors, including your driving habits, the prevailing conditions and your vehicle's equipment, condition and use.

OUTLANDER SPECIFICATIONS

Capacities	LS MT	LS CVT	LS CVT (7 seat option)	XLS	VR	VRX
	2WD/4WD	2WD/ 4WD		4WD		
Gross vehicle mass (kg)	2,270	2,270	2,270	2,270	2,270	2,270
Kerb mass (kg)	1,480 / 1,545	1,510 / 1,575	1,610	1,593	1,640	1,727
Payload (kg)*	790 / 725	760 / 695	660	677	695	608
Gross combination mass (kg)	3,620	3,620	3,620	3,620	3,775	3,775
Maximum towing capacity with trailer brakes (kg)**	1,500	1,500	1,500	1,500	1,600	1,600
Maximum towing capacity without trailer brakes (kg)	750	750	750	750	750	750
Towball download (kg)	150	150	150	150	160	160
Maximum Front Axle Load (kg)	1,090	1,090	1,090	1,090	1,090	1,090
Maximum Rear Axle Load (kg)	1,280	1,280	1,280	1,280	1,280	1,280
Seating Capacity	5	5	7	5	5	5

Interior Dimensions (mm)	5 seats	7 seats
Headroom		
Front row	1,023	1,023
2nd row	973	973
3rd row	-	899
Legroom		
Front row	1,056	1,056
2nd row	1,007	934
3rd row	-	704
Hiproom		
Front row	1,326	1,326
2nd row	1,319	1,319
3rd row	-	993

Exterior Dimensions (mm)	All models
Approach angle [degrees]	22
Departure angle [degrees]	21
Ramp breakover angle [degrees]	19

* Payload includes occupants, fuel & fitted options (if any). The weight of these must be deducted from Payload to determine actual load carrying capacity. Front &/or Rear Axle loads must not be exceeded.

**Subject to state regulations and towbar design.

*Ground Clearance unladen



Cargo Area	All models
Cargo dimensions (mm)	
Length – 2nd row seats down	1,697
Length – 2nd row seats up	983
Height	1,017
Width	1,426
Cargo capacity (L)	
2nd row seats down	1,691
2nd row seats up	882
2nd row seats upright to seatback	589
Steering	
Type	Power assisted rack and pinion steering

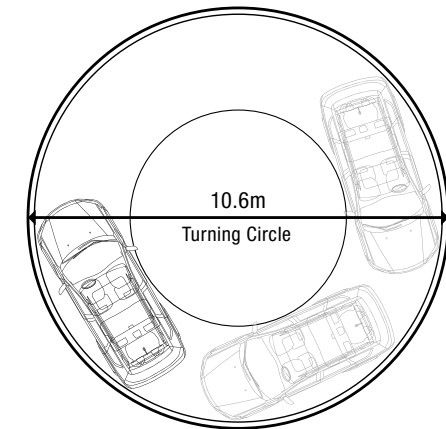

STYLE YOUR OUTLANDER

Colours



SAPPHIRE (P)



IRONBARK (P)



COOL SILVER (M)



BLACK (P)



EFFECT GREY (P)



RED (M)



WHITE

METALLIC (M) AND PEARLESCENT (P)
PAINTS ARE OPTIONAL EXTRAS

Interiors



LS – CLOTH



XLS – SPORTS CLOTH



VR – SPORTS CLOTH



VRX – LEATHER

10 **MITSUBISHI**
DIAMOND
ADVANTAGE **5**
AUSTRALIA'S BEST
NEW CAR WARRANTY,
CAPPED PRICE SERVICING
AND CUSTOMER CARE

NOW INCLUDING CAPPED PRICE SERVICING*
WARRANTY 10/5 YEAR ♦ **5 YEAR ROADSIDE ASSIST** ♦ **CUSTOMER ASSIST 24/7** ♦ **200+ DEALER NETWORK**
♦ **GENUINE SERVICE** ♦ **GENUINE PARTS** ♦ **INSURANCE** ♦ **FINANCE** ♦ **PRE-OWNED VEHICLES**

*10 year or 160,000km Powertrain Warranty (whichever comes first) (non transferable). *5 year or 130,000km New Vehicle Warranty (whichever comes first). ^5 year or 130,000km Roadside Assist (whichever occurs first). Service conditions apply. †4 year or 60,000km Capped Price Servicing (whichever comes first) Covers all items specified under the standard 'Maintenance for Normal Operating Conditions' schedule detailed in the Service and Warranty Booklet. Additional service/repair items (if required) are at additional cost. Excludes Government and Rental Fleet Customers. See your Dealer for full details.



Always consult your authorised Mitsubishi Dealer for the latest details on specifications, options, prices, availability and conditions on New Vehicle Warranty. All product illustrations and specifications referred to herein are believed to be correct at the time of publication approval. Subject to any applicable Federal, State or Territory Laws or ordinances, which may apply from time to time, Mitsubishi Motors Australia Limited reserves the right, without notice, or obligation, to discontinue or make changes to designs, specifications, colours and materials of the options and products referred to herein at any time without incurring any liability to any purchaser thereof. ©Mitsubishi Motors Australia Limited. ABN 53 007 870 395. sout1001. MIT4067.

11 MY January 2011

OUTLANDER ACCESSORIES



love that car



PERSONALISE YOUR VEHICLE

From the bonnet protector to the luggage pod, Mitsubishi has the accessories to suit your individual needs. Ask your Mitsubishi dealer for the complete list of accessories available for your new Outlander.

Mitsubishi Genuine Accessories go through an extensive program of design, development and testing to ensure they meet all applicable government standards as well as Mitsubishi's own rigorous engineering specifications and performance targets. Using Mitsubishi Genuine Accessories will ensure you get the best quality accessories that are both as durable and reliable as you should expect.



Bonnet Protector (also available in clear)



Headlamp Protectors



Tow Bar, Tow Ball & Tow Ball Cover



Fog Lamps



18" Alloy Wheels



Strut Brace



Rear Bumper Protection Plate



Rear Cargo Protection



Cargo Liner – to suit Rockford Fosgate



Cargo Liner – High Style



Front Mud Flap



Rear Cargo Separation Net

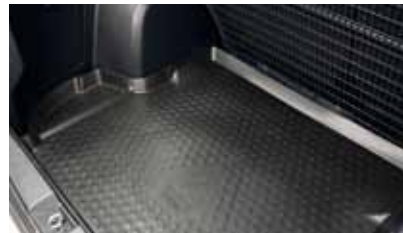

Cargo Liner



Cargo Net



Cargo Area Protector

EXTERIOR



Luggage Carrier & Net



Ski Attachment



Water Craft & Bike Carrier



Luggage Pod

When Genuine Accessories are fitted to your new vehicle at the time of delivery, they are covered by the Mitsubishi 3 year/130,000km (whichever comes first) Accessory Warranty. When they are fitted after purchase of your new vehicle they are covered for the remainder of the Accessory Warranty or for 12 months/20,000km, whichever is the longer. In the case of Diamond Spectrum Accessories the warranty is 12 months/20,000km (whichever comes first). ^Diamond Spectrum Accessories. Pictures shown for illustration purposes and may not be product specific. Please check with your Mitsubishi dealer for specific model applications. aout1008. MIT3812.

11MY August 2010

INTERIOR



Reversing Mirror / Camera



Bluetooth® Hands Free Kit



Luggage Room Rack



Carpet Mats (Rubber Also Available)



Scuff Plates (Front and Rear)



Neoprene Seat Covers



MMCS Including Satellite Navigation