



**Commercial  
Vehicles**

# The Transporter Range





Model shown with optional high roof.



<b>02</b>	<b>The Transporter Range</b>
<b>17</b>	Features
<b>18</b>	Safety
<b>19</b>	4MOTION
<b>20</b>	Accessories
<b>21</b>	Engines and transmission
<b>22</b>	Technical specifications
<b>22</b>	Drivetrain
<b>23</b>	Measurements and statistics
<b>26</b>	Standard and optional equipment
<b>28</b>	Paint colours
<b>29</b>	Trim
<b>30</b>	Owning a Volkswagen
<b>30</b>	Environment
<b>31</b>	General information

**A proud history.**





Thanks to enthusiastic patronage from rock bands and surfers to all manner of delivery businesses and everything in between, Transporter has become an automotive icon over the last sixty years. Launched way back in 1950, Transporter quickly established its credentials as one of the most popular commercial vehicles in the world – a much loved workhorse that combined form, function, versatility and

efficiency. These attributes have been essential components of every generation of Transporter since.

As you would expect, these days there are many more features that make up the unique DNA of the Volkswagen Transporter. For example, passenger safety and performance are cornerstone elements of the latest range of Transporters. Today's vans combine an

orchestrated network of intelligent systems and smart construction techniques to create the perfect working environment for modern businesses. Is it any wonder that it's still one of the most popular commercial vehicles in the world?

At Volkswagen, we are very proud of the incredible history of the Transporter. But we're even more excited about its future.



**Meet the Transporter family.**



Just like the Australian business landscape, Transporter comes in all shapes and sizes.

Choice of short and long wheelbase gives you the ability to carry different lengths of equipment. Standard, mid or high roof options provide you with scope in the other direction – up. Cab Chassis variants allow for creating your own load space to suit or come with a factory fitted tray that turns Transporter into a versatile workhorse. There's even a Crewvan model that can carry a combination of up to five people and cargo.

Then there's the choice of exciting engines and transmissions available for the Transporter range, the options and accessories, the trim and the colour schemes. And that's just what's available off the rack. You can always have something specially built to match your needs or have a specific fitout organised to suit your business perfectly. And for added peace of mind, the Transporter range now comes with 3 year unlimited kilometre warranty and Capped Price Servicing.

With Transporter, we make it our business to match yours.















# Transporter quick reference guide.





## Vans.

Model	Load Volume m <sup>3</sup>
Transporter short wheelbase with standard roof	5.8 
Transporter short wheelbase with optional medium roof	6.7 
Transporter long wheelbase with standard roof	6.7 
Transporter long wheelbase with optional medium roof	7.8 
Transporter long wheelbase with optional high roof	9.3 

## Cab Chassis.

Model	Load Capacity m <sup>2</sup>
Single Cab Chassis with long wheelbase	N/A 
Single Cab with dropside tray with long wheelbase	5.7 
Dual Cab Chassis with long wheelbase	N/A 
Dual Cab with dropside tray with long wheelbase	4.2 

## Crewvan.

Model	Load Volume m <sup>3</sup> (with rear bench seat removed)
Crewvan short wheelbase with standard roof	5.8 
Crewvan short wheelbase with optional medium roof	6.7 
Crewvan long wheelbase with standard roof	6.7 
Crewvan long wheelbase with optional medium roof	7.8 



## Transporter Van.

The classic Transporter Van is much more than a technological masterpiece, it's a perfect canvas for business signage giving you maximum exposure out there on the road.

And because we know that's where you'll probably be spending a vast majority of

your time, we've made sure that Transporter is a pleasure to drive, no matter how many hours you spend behind the wheel. That's why every element of the driver's environment has been created with ergonomics and safety in mind. And it's the little things that count with this working space – like large door pockets,

storage compartments, document and cup holders.

The rear load space is easy to access with a wide sliding door and a huge tailgate or optional twin rear doors. Depending on the model, the load compartment volume will range from 5.8m<sup>3</sup> to 9.3m<sup>3</sup>. The space

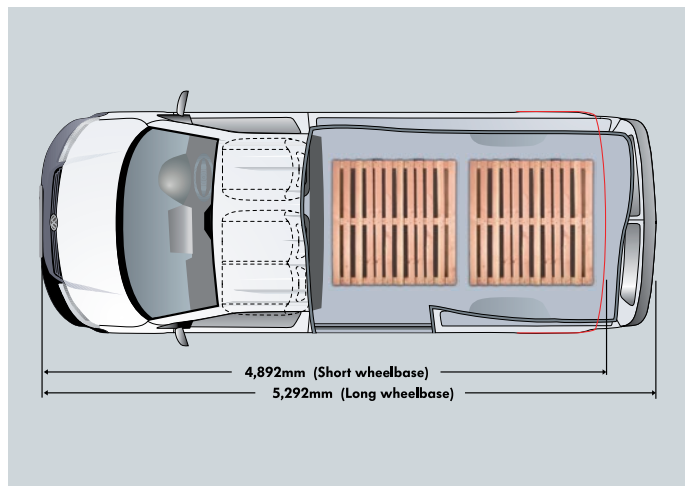

Load floor showing accommodation of two pallets.



Optional fixed partition with fixed window and wooden floor.



Twin rear doors\*.

itself is robust and versatile to take big loads – easily accommodating two pallets and standard building sheets. Well positioned lashing eyes ensure loads are securely locked down for transport.

\* Optional (Standard with LWB, high roof.)



## Transporter Crewvan.



Armrests and twin rear doors are optional. "Place" seat fabric shown is no longer available. Please refer to page 29 for "Austin" trim sample.



Overseas model shown.

Need a Transporter that can take a team of five and the gear? The Crewvan is the Transporter for you. Transporter Crewvan has window inserts in the side sliding door and a rear bench seat behind the driver and front passenger seats, easily accommodating three additional passengers in the back. And because

there's a mile of room behind the second seat, there's plenty of space to load equipment, tools and raw materials.

The flexible design and in-built seating options together with heavy-duty rubber floor protector make Crewvan a functional, versatile workhorse. And if you should

need extra room to carry a little more gear and equipment, in seconds, you can fold away the extra bench seat in the rear and you've got additional rear space at your disposal. There is a choice of standard or medium roof heights and a load volume range of 5.8m<sup>3</sup> to 7.8m<sup>3</sup> depending on roof height and seat configuration.



## Transporter Single Cab and Dual Cab.

Not all businesses do straightforward deliveries. That's why we have a range of Single and Dual Cab options available in Transporter.

If you're creating your own space in the back, the tough chassis of the Transporter is an ideal blank canvas to start with. The generous wheelbase length and heavy duty GVM rating mean you can customise the back to suit your work needs. And if you already have a specialised fitout on a previous Volkswagen Transporter and want to upgrade to a new Transporter, that's fine too. Every square centimetre of space is utilised in these uncompromising

work vehicles. The Single Cab Chassis is equipped with a double bench seat and separate driver seat as standard allowing for three people. The Dual Cab Chassis has two seats in the front and adds a rear bench seat for three providing ample room to take a team of five (or six with the optional front passenger bench seat).

The Single and Dual Cab Transporter with dropside tray is equally popular. With a full size tray on the Dual Cab option, it's one of the most impressive work utes around – perfect for big loads and a big team. There's even space beneath the rear three-seater bench for

Vehicle fitout for illustration purposes only. Please contact your local Volkswagen dealer for further information.



Transporter

storing valuables or tools out of sight. Of course, if you don't need to carry more than three people and need more tray capacity, the Single Cab is available with a huge dropside tray on the back for larger loads.

The Single Cab and Dual Cab range comes with Volkswagen's fuel efficient TDI engines paired with either manual or 7-speed DSG transmission for superb performance and fuel efficiency. They also boast all the safety features that make Transporter a must buy for those who are serious about their work.





Model shown with optional RNS315 Satellite Navigation System.

## At home in the mobile office.

Seats that hug and support your back, clear and clever instrumentation, ergonomically shaped steering wheel that adjusts to your height and reach requirements, storage containers within easy reach, smooth gearstick at the ready. The Transporter cockpit has been designed and laid out to the millimetre. Would you expect anything less from German design?

And these are the things that you can see. What you won't see is the raft of safety equipment to keep you protected. Features like driver and passenger airbags, optional side and head airbags, Electronic Stabilisation Programme (ESP), Anti-Lock Brake System (ABS), Brake Assist and Electronic Brake Distribution (EBD). And then there's the superbly designed and crafted Transporter framework that sits beneath the surface.

Behind the wheel, you'll enjoy a responsive, smooth driving experience, with sure gear changes, positive handling and plenty of thrust from eager engines. And now Bluetooth™ phone interface is available as an option, to ensure you're always safe and in touch. Transporter is such a pleasure to drive, it actually doesn't feel like you're driving a van.

If you're going to make Transporter your office then you can rest assured that you'll be going to work in one of the safest, most comfortable vans on the road anywhere.

The Bluetooth™ word mark is owned by The Bluetooth SIG, Inc. Not all devices will be compatible and functionality will vary depending on the device.



## Features

The Transporter range is equipped for practicality, comfort and worry-free driving. Standard features include driver and front passenger airbag, central locking with radio-remote control and electrically adjustable door mirrors with heating function. Say goodbye to hill starts with Hill Hold on all variants. A variety of optional assistance systems add a finishing touch to the comfort and convenience of your Transporter.



**Cruise control system.** A touch of a button and speed can be set at a constant level – the system is deactivated by operating the lever or depressing the brake or clutch pedal. A handy speed limiter function is also included.

(Standard on TD1400)

**T TC TSC TDC**



**Double bench seat with folding table.** Accommodate an extra passenger in your Transporter with this double bench seat, with the added convenience of a folding table and extra storage.

Overseas model shown.

**T TC TSC TDC**

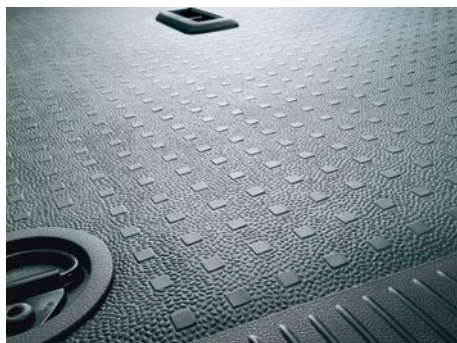

**Rubber floor covering in cargo area.** Protect your load space from impacts, scratching and spills. Manufactured from highly durable chemical resistant & UV stable high molecular weight polyethylene.

**T TC**



**Park distance control – rear.** Never be caught by a blind spot when parking again. Park distance control acoustic warning signal helps you to reverse into the tightest of spots with ease.

Overseas model shown.

**T TC**



**Fixed window.** For added visibility the fixed window can be included on the right and left side of your Transporter.

Overseas model shown.

**T TC**

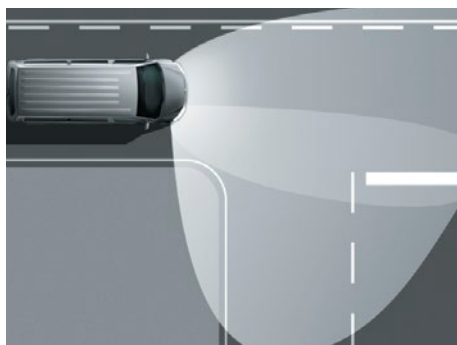

**The front fog lights with integrated turning lights,** lights up curves and bends on the road when you make a turn at 40 km/h or less. This allows you to anticipate possible risks sooner.

**T TC TSC TDC**



**Body coloured bumpers.** Enhance the look of your Transporter with body coloured bumpers (limited colours available for Single Cab).

**T TC TSC TDC**

### Mobile phone preparation.

(Not illustrated) Negotiating around busy roads and taking calls on the fly is now much easier thanks to this handy kit. It pairs with all major phones and installs neatly on the dash.



**T TC TSC TDC**

The Bluetooth™ word mark is owned by The Bluetooth SIG, Inc. Not all devices will be compatible and functionality will vary depending on the device.

standard    **T** Transporter Van  
 optional extra    **TC** Transporter Crewvan

**TSC** Transporter Single Cab  
**TDC** Transporter Dual Cab

## Safety

You should not only feel comfortable in the Transporter but safe, too. An intelligent, comprehensive safety system gives you support during the journey and offers you the best possible protection from injury in the event of an accident.



The **Electronic Stabilisation Programme (ESP)**, including hill holder, helps prevent the vehicle from swerving in critical driving conditions.

**T TC TSC TDC**

# EBD

**Electronic Brakeforce Distribution (EBD)** prevents lock-up of the rear wheels when the vehicle weight is transferred to the front wheels under heavy braking.

**T TC TSC TDC**



The **seat belt warning** reminds the driver that seat belts are not fastened.

**T TC TSC TDC**



The **Anti-lock Braking System (ABS)** prevents wheels from locking up and improves manoeuvrability.

**T TC TSC TDC**



The **Brake Assist** system recognises the speed at which the brake pedal is pushed. Under reflex or emergency braking, the system senses the urgent need and applies full brake pressure more rapidly.

**T TC TSC TDC**



**Airbags.** For optimal protection, the Transporter is equipped with airbags for the driver and front passenger as standard. Side and head airbags are available for the cab as an option. When a 2-seater front passenger bench seat is selected, it is not possible to order side or head airbags.

**T TC TSC TDC**

standard    **T** Transporter Van  
 optional extra    **TC** Transporter Crewvan

**TSC** Transporter Single Cab  
**TDC** Transporter Dual Cab

## 4MOTION

The addition of 4MOTION will provide your Volkswagen Transporter with sure footed agility in the most trying of surface conditions and can take you further off the beaten track. 4MOTION is as simple as it is effective – at its heart is a unique Haldex system that anticipates slip, rather than reacting to it once the tyres lose traction. The system draws data from a range of sensory inputs on the running gear. This data is delivered immediately into an electronically controlled clutch which constantly calculates load requirements and pushes drive between the front and rear wheels with a wide range of variability according to surface conditions and driving forces. 4MOTION excels on bitumen roads and comes into its own on open terrain, providing the tangible benefits of all-wheel drive.



**Wading depth:** up to 300mm. With the Transporter you can cross deep puddles and standing water up to a depth of 30cm safely and conveniently. Flooded roads and building sites after heavy rainfall also present no difficulties. Measured with a full load at a maximum of 30 km/h.



**Approach angle:** 21°; departure angle: 17°. Short inclines are no problem for the Transporter. Due to the wheelbase, the bumpers do not make contact with the ground even when the approach angle is 21°. Measured with standard equipment and a full load.



**Ramp angle:** 14°. So that the journey over difficult roads and small inclines does not end abruptly, the Transporter can even easily cope with crests with a ramp angle of up to 14°. Measured with standard equipment and a full load.



**Hill-climbing ability:** 37°. Small earth mounds, medium slopes and steep inclines up to a slope of 37° can be mastered with ease by the Transporter with TDI400 engine\* and a vehicle weight of 3,000kg.

\*Figures may vary depending on the equipment line and engine type. Please note that these are statically calculated figures. Please contact your local Volkswagen dealer for details of the standard equipment and optional extras applicable.

## Accessories

Apart from the functionality, versatility, engineering, clever design and driving pleasure of the Volkswagen Transporter range, there is a range of useful accessories that add considerable value and customises your Transporter to suit your business needs.



**Rubber Floor mats.** If the most important thing is keeping things dry, the rubber floor mat set is the ideal solution. Dirt and moisture are collected and then removed by simply washing them away. The rubber floor mats are made to measure and secured to prevent slipping.



**Roof bars.** Lockable roof racks that are designed to fit onto the roof seamlessly. They maximise roof space to carry extra loads and longer bulky items like ladders, pipes, timber, scaffolding or sporting equipment with a multitude of roof bar fixtures for your bikes or kayak.



**Slimline weather shields.** These slimline weather shields complement the shape of your windows and can be fitted to driver and passenger doors, allowing you to have the windows part way down when it rains.

Overseas model shown.



**Park distance control – rear.** Four sensors and an acoustic warning signal help the driver while parking backwards. The park distance control is automatically activated when the reverse gear is engaged and is confirmed with a brief signal tone.



**Towbar kit.** The Transporter has plenty of room on board, but if you need additional space and want to tow a trailer, these genuine towbars have a 2,000kg braked towing capacity and 750kg unbraked with a 100kg downball weight that gets the job done.



**Loading sill guard.** The loading sill guard is made of plastic with a high quality stainless steel look, is easy to glue on and will protect the bumper against scratching when loading and unloading.

## Engines and transmission

The sleek bonnet of the Transporter hides a powerful engine. In fact, there's a range of 2.0 litre common rail turbo-diesel engines to choose from. These engines yield torque outputs of 250Nm, 340Nm up to a mighty 400Nm of torque. They also feature low fuel consumption and manage considerable reductions on emissions. You'll be impressed with

these amazing engines – particularly the high torque and incredible efficiency.

The TDI250 model is paired with a silky smooth 5-speed manual gearbox while the TDI340 engines can be matched with a 6-speed manual gearbox or Volkswagen's 7-speed Direct Shift Gearbox (DSG) system. The top of the line TDI400

Bi-turbo engine has two turbochargers for extra thrust and smooth delivery of power.

This engine can be paired with the 6-speed manual or 7-speed DSG and comes with the option of Volkswagen's legendary 4MOTION all-wheel drive system for extra grip.

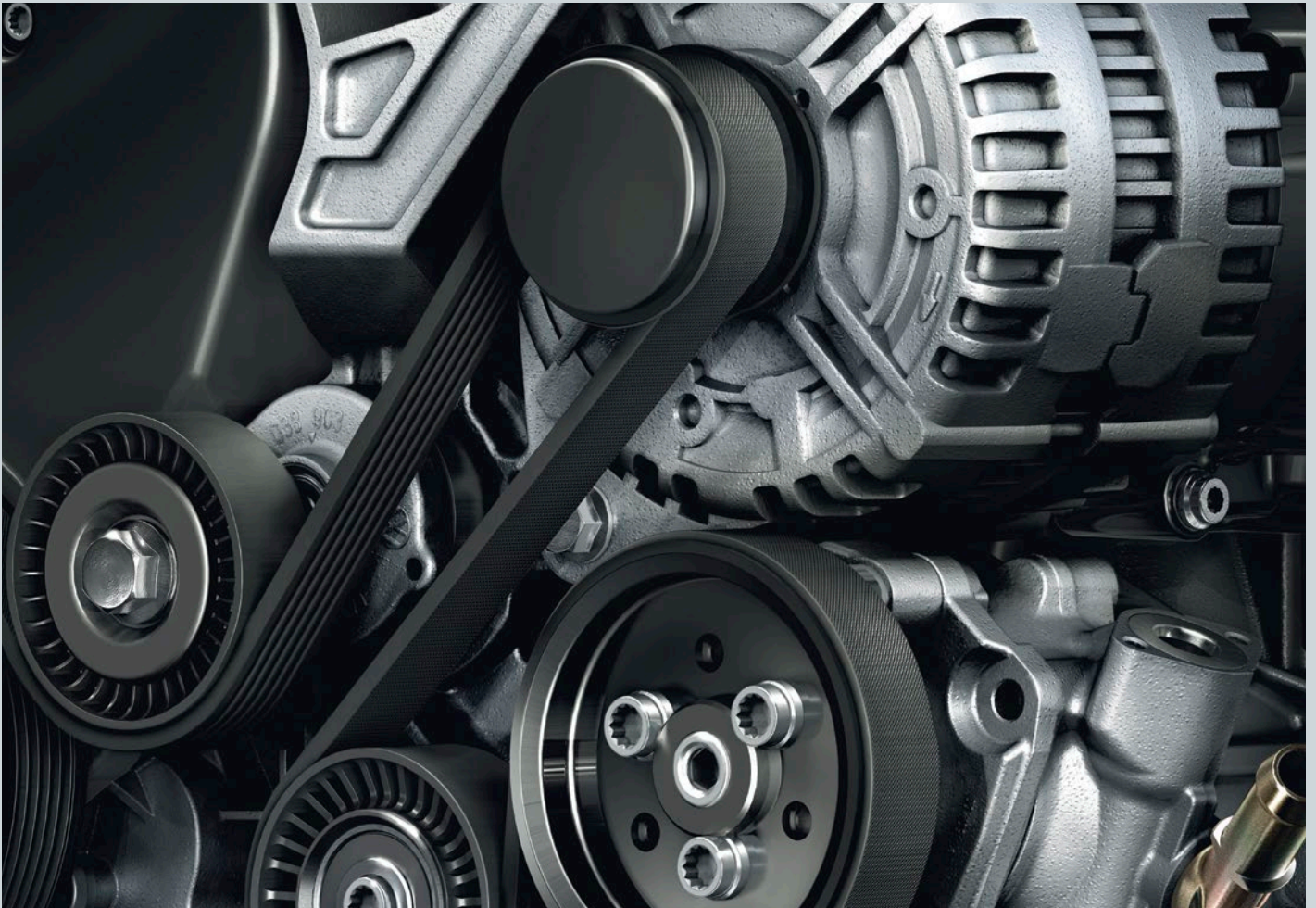

### Direct Shift Gearbox (DSG)

Volkswagen's Direct Shift Gearbox (DSG) makes inner city driving and tough commercial work easier. Unique in the commercial vehicle sector, the DSG system is not just one automatic clutch, it's two – both working in tandem to deliver the smoothest, fastest, most efficient auto transmission anywhere. While one clutch is engaged and powering your Transporter along, the

other is ready to accept the next gear. This twin clutch technology means you can change gear much faster than with a standard automatic gearbox – actually, in less than four hundredths of a second. Think about the stop-start nature of working in the city and you'll realise just how valuable DSG will be in your Transporter.



## Technical specifications

Engine	Transporter TDI250	Transporter TDI340	Transporter TDI400
Type	4 Cylinders, DOHC, 16 Valve	4 Cylinders, DOHC, 16 Valve	4 Cylinders, DOHC, 16 Valve
Capacity, litres/cc	2.0 / 1,968	2.0 / 1,968	2.0 / 1,968
Installation	Transverse installation	Transverse installation	Transverse installation
Bore x Stroke / Compression ratio	81.0mm x 95.5mm / 16.5:1	81.0mm x 95.5mm / 16.5:1	81.0mm x 95.5mm / 16.5:1
Construction materials	All alloy	All alloy	All alloy
Maximum power, kW @ rpm	75 @ 3,500	103 @ 3,500	132 @ 4,000
Maximum torque, Nm @ rpm	250 @ 1,500 – 2,500	340 @ 1,750 – 2,500	400 @ 1,500 – 2,000
Induction type	Single turbocharger	Single turbocharger	Bi-turbochargers
Intercooled	Yes	Yes	Yes
Emissions standard*	Euro 5 with Diesel Particle Filter (DPF)	Euro 5 with Diesel Particle Filter (DPF)	Euro 5 with Diesel Particle Filter (DPF)
Transmission – manual	5 Speed	6 Speed	6 Speed
Transmission – automatic	–	7 Speed DSG	7 Speed DSG
Driven wheels	Front wheel drive	Front wheel drive	Front wheel drive/Optional 4MOTION
<b>Wheels and tyres</b>			
Wheels	Steel 16" x 6.5J	Steel 16" x 6.5J	Steel 17" x 7J
Tyres	205/65 R16C 107/105T	205/65 R16C 107/105T (Van) 215/65 R16 106/104T (Single Cab)	235/55 R17 103W
<b>Fuel consumption and performance</b>			
Fuel type	Diesel	Diesel	Diesel
Fuel system	Common Rail Direct Injection	Common Rail Direct Injection	Common Rail Direct Injection
Fuel tank capacity, litres	80	80	80

	Single Cab	Dual Cab	Vans (incl. Crewvan)		
	TDI340 Comb / Urban / Ex Urban • CO <sub>2</sub>	TDI400 Comb / Urban / Ex Urban • CO <sub>2</sub>	TDI250 Comb / Urban / Ex Urban • CO <sub>2</sub>	TDI340 Comb / Urban / Ex Urban • CO <sub>2</sub>	TDI400 Comb / Urban / Ex Urban • CO <sub>2</sub>
Manual, Litre/100km • CO <sub>2</sub> g/km	8.1 / 10.2 / 6.9 • 214	8.1 / 9.8 / 7.1 • 214	7.5 / 9.7 / 6.3 • 198	7.7 / 9.8 / 6.5 • 203	7.8 / 9.8 / 6.7 • 205
Automatic, Litre/100km • CO <sub>2</sub> g/km	8.5 / 10.4 / 7.4 • 224	8.4 / 10.2 / 7.3 • 221	–	8.2 / 10.4 / 6.9 • 216	8.1 / 10.2 / 6.9 • 214
4MOTION Manual, Litre/100km • CO <sub>2</sub> g/km	–	8.7 / 10.5 / 7.6 • 229	–	–	–
4MOTION DSG, Litre/100km • CO <sub>2</sub> g/km	–	–	–	–	8.4 / 10.5 / 7.2 • 221

## Drivetrain

Suspension and steering	TDI250	TDI340	TDI400
Front axle	Independent McPherson struts, sub-frame with coil springs and gas filled dampers		
Rear axle	Semi-trailing independent rear axle with coil springs and anti-roll bar		
Steering	Rack and pinion power steering		
Turning circle	SWB: 11.9m / LWB: 13.2m		
<b>Brakes</b>			
Front disc brakes – vented, mm	308	308	340
Rear disc brakes – solid, mm	294	294	294
Brake systems	ESP, ABS, ASR, MSR, EDL and Hill Holder		

\* Emission level according to European Regulation (EC) No. 715/2007 and Regulation (EC) No. 692/2008. The information and the specifications contained within this document were correct at the time of issue. Due to our continuous process of improvement our products are continually updated and changes may be made to the specifications from time to time. Not all vehicles or options may be available. Check at time of ordering.

## Measurements and statistics

<b>Weights</b>	<b>Transporter Single Cab TDI340</b>	<b>Transporter Dual Cab TDI400</b>
Towing capacity, braked / unbraked, kg	2,000 / 750	2,000 / 750
Towing downball load, kg	100	100
GVM, kg	3,000	3,000
Unladen mass <sup>1</sup> , kg	1,649	1,740
Payload <sup>2</sup> – manual, kg	1,350	1,260

	<b>Transporter Van TDI250</b>	<b>Transporter Van TDI340</b>	<b>Transporter Van TDI400</b>
Towing capacity, braked / unbraked, kg	2,000 / 750	2,000 / 750	2,000 / 750
Towing downball load, kg	100	100	100
GVM, kg	3,000	3,000	3,000
Unladen mass <sup>1</sup> SWB standard roof height, kg	1,722	1,752	1,802
Unladen mass <sup>1</sup> LWB standard roof height, kg	1,778	1,808	1,859
Payload <sup>2</sup> SWB, kg	1,277	1,247	1,197
Payload <sup>2</sup> LWB, kg	1,221	1,191	1,140

	<b>Transporter Crewvan TDI340 6-speed Manual</b>	<b>Transporter Crewvan TDI340 7-speed DSG</b>
Towing capacity, braked / unbraked, kg	2,000 / 750	2,000 / 750
Towing downball load, kg	100	100
GVM, kg	3,000	3,000
Unladen mass <sup>1</sup> SWB standard roof height, kg	1,872	1,884
Payload <sup>2</sup> SWB, kg	1,127	1,115
Unladen mass <sup>1</sup> LWB standard roof height, kg	1,936	1,948
Payload <sup>2</sup> LWB kg	1,064	1,052

## Transporter Van

<b>Exterior dimensions</b>	<b>SWB</b>	<b>LWB</b>
Length, mm	4,892	5,292
Width, mm	1,904	1,904
Height standard / med / high, mm	1,990 / 2,176 / –	1,990 / 2,176 / 2,476
Wheelbase, mm	3,000	3,400

<b>Interior dimensions (Wheelbase – roof height)</b>	<b>SWB – standard</b>	<b>SWB – medium</b>	<b>LWB – standard</b>	<b>LWB – medium</b>	<b>LWB – high</b>
Load volume, m <sup>3</sup>	5.8	6.7	6.7	7.8	9.3
Maximum length, mm	2,353	2,353	2,753	2,753	2,753
Maximum width, mm	1,692	1,692	1,692	1,692	1,692
Maximum width at wheel arches, mm	1,244	1,244	1,244	1,244	1,244
Maximum height, mm	1,410	1,626	1,410	1,626	1,940

<b>Cargo entry</b>	<b>SWB (Van, Crewvan)</b>	<b>LWB (Van)</b>
Rear tailgate width, mm	1,486	1,486
Rear tailgate height, mm	1,305	1,305
Lateral sliding doors width, mm	1,020	1,020
Lateral sliding doors height, mm	1,284	1,284

<sup>1</sup> The Unladen Mass (UM) includes 10L of fuel, vehicle fluids and no occupants. Figures quoted are for base model vehicles only. <sup>2</sup> Payload figures determined by subtracting 'Unladen Mass' (UM) from total 'Gross Vehicle Mass' (GVM). A vehicle's final payload, given the different available configurations, can only be determined by weighing the individual vehicle and comparing to the known GVM. Figures quoted are for base model vehicles only.

# Measurements and statistics

## Transporter Van (continued)

Warranty and service	
Vehicle	3 Years, Unlimited km
Paint / Corrosion	3 Years / 12 Years
Road side assistance	3 Years, Unlimited km

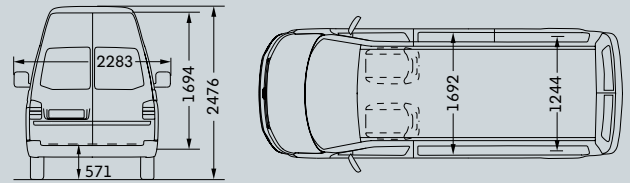
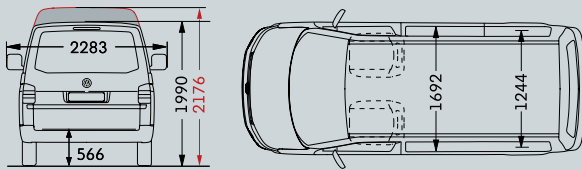
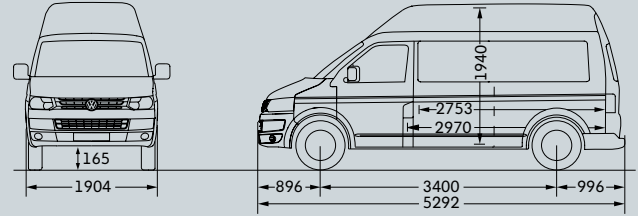
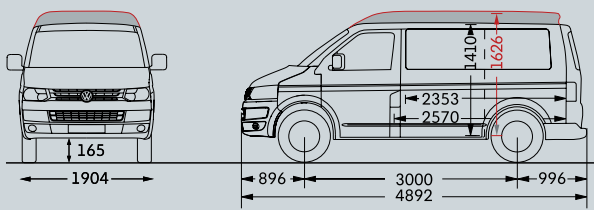

**Transporter SWB – Standard/Medium**

**Transporter LWB – High**

## Transporter Cab Chassis

Exterior dimensions	Single Cab	Dual Cab
Length, mm	5,292	5,292
Width, mm	1,904 (not including mirrors)	1,904
Height, mm	1,949	1,963
Wheelbase, mm	3,400	3,400

Warranty	
Vehicle	3 Years, Unlimited km
Paint / Corrosion	3 Years / 12 Years
Road side assistance	3 Years, Unlimited km

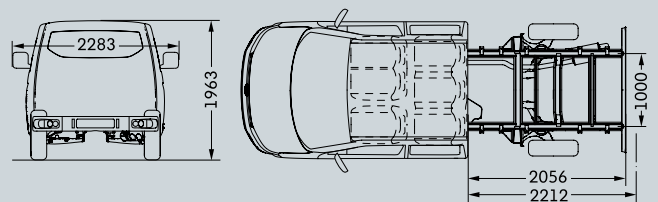
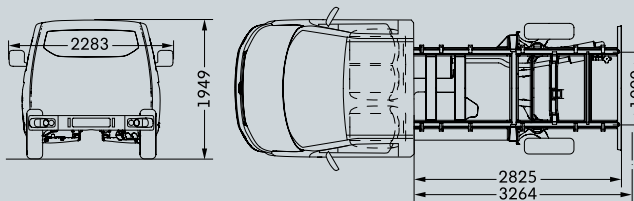
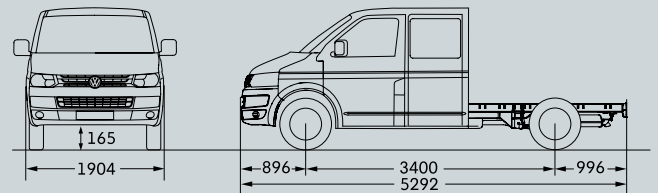
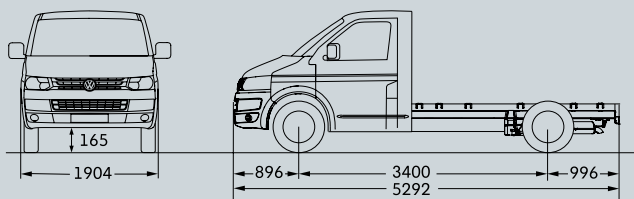

**Transporter Single Cab Chassis**

**Transporter Dual Cab Chassis**



# Measurements and statistics

## Transporter Crewvan

Exterior dimensions	SWB	LWB
Length, mm	4,892	5,292
Width, mm	1,904	1,904
Height standard / med / high, mm	1,990 / 2,176 / –	1,990 / 2,176 / –
Load volume, m <sup>3</sup> *	5.8	6.7
Maximum length, mm	2,353	2,753
Maximum width, mm	1,692	1,692
Maximum width at wheel arches, mm	1,244	1,244
Maximum height, mm	1,410	1,410
<b>Cargo entry</b>		
Rear tailgate width, mm	1,486	1,486
Rear tailgate height, mm	1,305	1,305
Lateral sliding doors width, mm	1,020	1,020
Lateral sliding doors height, mm	1,284	1,284
<b>Warranty</b>		
Vehicle	3 Years, Unlimited km	
Paint / Corrosion	3 Years / 12 Years	
Road side assistance	3 Years, Unlimited km	

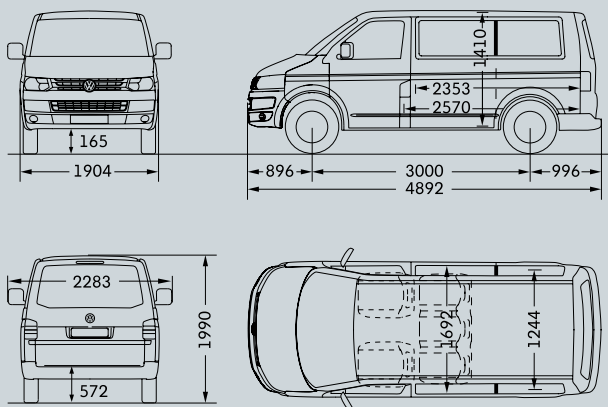

**Transporter Crewvan SWB – Standard**

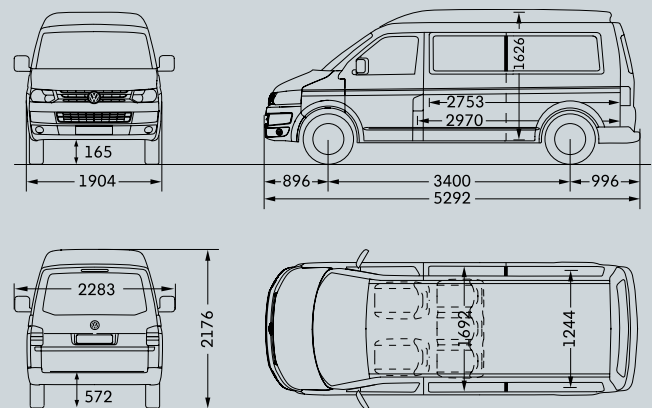

**Transporter Crewvan LWB – Medium**

\* With standard roof height and rear bench seat removed

## Standard and optional equipment

<b>Safety and security</b>	<b>Van</b>	<b>Crewvan</b>	<b>Single Cab</b>	<b>Dual Cab</b>
Front height adjustable 3 point seatbelts with pre-tensioners	S	S	S	S
3 Point seatbelts for 2nd row	–	S	–	S
Driver and front passenger airbag	S	S	S	S
Driver and front passenger head/thorax airbags	O	O	–	O
Anti-lock Braking System (ABS) with Electronic Brake Distribution (EBD)	S	S	S	S
Brake Assist (BA)	S	S	S	S
Anti-Slip Regulation (ASR)	S	S	S	S
Electronic Stability Programme (ESP)	S	S	S	S
Electronic engine immobiliser	S	S	S	S
Remote central locking with 2 remote keys	S	S	S	S
Alarm with back-up horn	O	O	O	O
Lockable glovebox	S	S	S	S
Child restraint anchor points (3 in second row of seats)	–	S	–	–
<b>Driver assist</b>				
Hill hold control	S	S	S	S
Side Assist (SWB Vehicles only)	O	O	–	–
Rear View Camera (RVC Plus) – only with RNS510	O	O	–	–
Park distance control – front and rear	O	O	–	–
Park distance control – rear	O	O	–	–
<b>Audio and media</b>				
RCD210 Radio CD Player with MP3 Single Din	S	S	S	S
RCD310 Radio CD Player with MP3 Double Din with Aux-In	O	O	O	O
RNS315 Satellite Navigation / Multimedia 5" touch screen, SD card reader, 30GB hard drive for maps. Also includes AM/FM radio with RDS and single CD player	O	O	O	O
RNS510 Satellite Navigation/Multimedia 6.5" touch screen, SD card reader, 30GB hard drive for maps. Also includes AM/FM radio with RDS and single CD player	O	O	O	O
iPod®* and iPhone®* connector – only with RCD310	O	O	O	O
Bluetooth™* connectivity, including hands-free phone operation	O	O	O	O
<b>Exterior</b>				
Metallic paint	O	O	O	O
Pearl effect paint	O	O	O	O
Body coloured bumpers (limited colours)	O	O	O	O
High roof in body colour – LWB only (add 50kg to unladen mass, limited colours)	O	–	–	–
High roof in white – LWB only (add 50kg to unladen mass)	O	–	–	–
Medium roof in body colour (limited colours)	O	O	–	–
Medium roof in white (add 30kg to unladen weight)	O	O	–	–
C Rails – roof rack mounting rails for movable roof rack (not with medium or high roof)	O	O	–	–
Front and rear mud flaps (front only for Cab Chassis)	S	S	S	S
Alloy tray with tie down points and rear mud flaps	–	–	O	O
<b>Wheels and tyres</b>				
17" x 7J Alloy wheels "Thunder" with 235/55 R 17 103 W tyres	O	O	O	O
<b>Seats</b>				
Fabric seat coverings "Austin"	S	S	S	S
Double bench seat in front row with storage compartment	O	O	S	O
Driver and front passenger seat with height adjustment, lumbar support and armrest	O	O	–	O
Drivers seat height adjustment with lumbar support and armrest	O	O	O	O
2nd row 3-seater bench (passenger compartment)	–	S	–	S

## Standard and optional equipment

Windows and doors	Van	Crewvan	Single Cab	Dual Cab
Left hand side sliding door	S	S	–	–
Right hand side sliding door	O	O	–	–
Power sliding side doors (left and right)	O	O	–	–
Rear wing doors with heated windows	O	O	–	–
Fixed partition with fixed window	O	–	–	–
Fixed window (centre left/right), per side	O	S	–	–
Sliding window (centre left/right), per side	O	O	–	–
Front electric windows with roll-back function (Driver and Passenger with one-touch up/down)	S	S	S	S
Heated window on rear tailgate	S	S	–	–
<b>Air conditioning</b>				
'Climatic' air conditioning	S	S	S	S
<b>Interior</b>				
3-spoke steering wheel	S	S	S	S
3-spoke leather multifunction steering wheel	O	O	O	O
Dash mounted gear shifter	S	S	S	S
Comfort Package – includes cab noise reduction + 2 x sunvisor vanity mirror + 2 x A pillar grab handle + dimmable dash panel and two tone horn	O	S	O	O
Sliding/tilting sunroof in cab	O	O	–	–
Rubber floor for cargo area	O	S	–	–
Wooden floor for cargo area	O	O	–	–
Multifunction display dash insert changes to have fuel and temp in separate gauges plus monochrome multifunction display – shows route time, average speed, actual speed, oil temp, speed warning, travel time, actual fuel consumption, average fuel consumption and range	O	O	O	O
<b>Comfort</b>				
Cruise control (standard on TDI400)	O	O	O	S
Electrically adjustable door mirrors with heating function	S	S	S	S
<b>Lighting</b>				
Light and Sight package – includes dusk sensing headlights with 'coming home' function, rain sensing wipers and auto dimming rear view mirror	O	O	O	O
Daytime running lights	S	S	S	S
Front fog lamps with cornering function	O	O	O	O
Rear fog lamp	S	S	S	S
<b>Instrumentation</b>				
Speedometer and tachometer, electronic odometer and trip meter, digital clock, fuel and coolant indicators, low fuel warning light, outside temperature and fuel gauge	S	S	S	S
<b>Mechanical</b>				
Suspension upgrade 1 (Reinforced standard dampers and springs) for rough road use. Not with High Roof	O	O	O	O
Suspension upgrade 2 (Upgraded dampers and springs) for rough road use	O	O	O	O
Mechanical rear differential lock (4MOTION models only)	O	O	–	O
2nd Battery	O	O	O	O

The Bluetooth™ word mark is owned by The Bluetooth SIG, Inc. Not all devices will be compatible and functionality will vary depending on the device. \* iPod® and iPhone® are registered trademarks of Apple Inc.

S = Standard – = Not Available O = Optional

## Paint colours

The bodywork is galvanised first to give your Volkswagen Commercial Vehicle optimum protection against mechanical and chemical influences. Only then is the paint applied in several layers and left to harden. The result is a scratch-resistant, hard finish for the top coat.

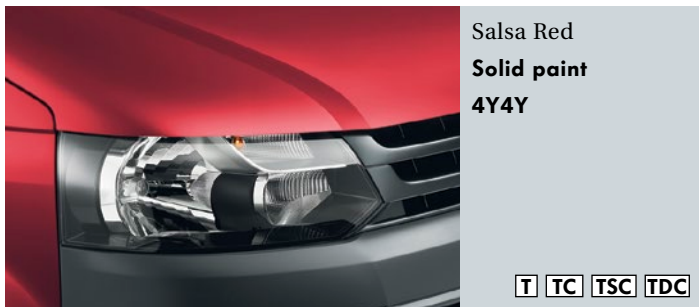

standard     **T** Transporter Van     **TSC** Transporter Single Cab  
 optional extra     **TC** Transporter Crewvan     **TDC** Transporter Dual Cab



## Trim

High-quality, robust materials and skilled workmanship are essential in the manufacture of hard-wearing seat upholstery. The colours and patterns for the upholstery are painstakingly matched to the interior trim and paint finishes.



\* Metallic and pearl effect paint are available at extra cost. The illustrations on these pages can only be regarded as a general guide as the printing process cannot render the colours with absolute accuracy. Please contact your local Volkswagen Commercial Vehicle dealer for details of the standard equipment and optional extras available. \* The seat pattern on the left shows the centre panel, and the seat pattern on the right shows the outer panel.

## Owning a Volkswagen

### Volkswagen New Vehicle Warranty

Volkswagen Transporter is covered by a 3-year/unlimited kilometre manufacturer's warranty, which includes Volkswagen Assist (24 hour roadside assistance). Transporter is also covered by a 3-year paintwork and 12-year anti-corrosion perforation warranty.

### Volkswagen Assist 24 hour roadside assistance

As a valued customer, you can be assured that, wherever you travel within Australia, you will have access to roadside assistance, 24 hours a day, 365 days a year. This is complimentary for the duration of the vehicle's original Volkswagen warranty period. You will receive help in the event of a breakdown or accident and, if required, your vehicle will be mobilised or transported to an Authorised Volkswagen Repair Centre.

### Volkswagen Extended Warranty

Why not continue the confidence of a Volkswagen Warranty by purchasing a Volkswagen Extended Warranty? For further details on this option, please contact your local Volkswagen Dealer.

## Environment

On a local level, we have undertaken a number of initiatives to reduce the environmental impact of our business processes, including careful recycling of office waste, for example. Energy usage is being reduced through lights controlled by motion sensors in toilets, kitchens and meeting rooms.

But there's no question that the area in which we can contribute most to environmental sustainability is with our vehicles. Our TDI diesel engines consume less fuel and emit less exhaust fumes offering high torque and performance,

### Volkswagen Service

Your Authorised Volkswagen Service Centre is part of Volkswagen's global Quality Management System, ensuring all dealers are certified to ISO 9001:2000 – an internationally recognised Quality Standard. Authorised Volkswagen Service Centres have factory trained technicians equipped with the very latest diagnostic equipment, specialist tooling and Volkswagen Genuine Parts. An Authorised Volkswagen Service Centre undertakes work in accordance with factory specified guidelines and maintenance schedules.

### Volkswagen Genuine Parts®

Volkswagen Genuine Parts® are designed for your vehicle and approved by Volkswagen, with particular regard to safety. The workmanship, dimensional accuracy and materials used in these parts comply with factory specifications. To ensure safety and reliability, Volkswagen recommends the use of Volkswagen Genuine Parts®. Volkswagen Authorised Dealers offer a 2-year warranty on Genuine Parts from the date of purchase.

while our diesel particulate filters extract soot from the exhaust fumes. All Transporter engines already fulfill the very stringent Euro 5 emissions standards.

Our dual-clutch DSG gearbox provides the comfort of conventional automatic transmission and the dynamic drive of a manual transmission. It has significantly lower fuel consumption in comparison with a conventional automatic transmission with torque conversion.

### Capped Price Servicing

Volkswagen Commercial Vehicles have introduced Capped Price Servicing across the entire Commercial Vehicle Range. This new program supports our commitment to customer satisfaction and provides total transparency for complete peace of mind.

All vehicles registered after 1 January 2013 will be covered for a total of 90,000km (or 180,000km for Crafter models) or six years (whichever comes first). Our scheduled service includes the regular replacement of oil filters, engine oil and sump plug washer at each service interval, as well as the standard replacement of the air filter (at 45,000 and 90,000km) and spark plugs (every 60,000km).

To reference how much each service will cost for your specific Volkswagen Commercial Vehicle, you can contact your participating Volkswagen dealer or go to [www.volkswagen-commercial.com.au](http://www.volkswagen-commercial.com.au)



## General information

Volkswagen is distributed by Volkswagen Group Australia Pty Ltd. 24 Muir Road, Chullora, NSW 2190. ABN 14 093 117 876. Specifications are as planned at January 2014 for model year 2014 and are subject to change without notice or obligation. Cars and accessories are shown for illustrative purposes only and may not depict Australian specifications. Fuel consumption figures according to Australian Design Rules (ADR) 81/02. All Volkswagen approved parts and accessories are warranted for 2 years/unlimited kilometres. All warranties implied by legislation or otherwise are excluded to the maximum extent permitted by law. The liability of Volkswagen shall, subject to the law, be limited at Volkswagen's discretion: 1. In the case of the goods, the repair or the cost of repair, or the replacement or the cost of replacement; and 2. In the case of services, the re-supply of the services or the cost of re-supply of the services. All information in this brochure is correct at time of publication, however variations may occur from time to time and Volkswagen, in so far as it is permitted by law to do so, shall not be liable in any way as a result of any reliance by any person on anything contained in this brochure. The colours shown in the brochure are indicative only and may vary from actual items owing to the printing process. Authorised Volkswagen dealers will provide up-to-date information on model application, design feature, prices and availability on request. Volkswagen Insurance & Volkswagen Extended Warranty are provided by Allianz Australia Insurance Limited (Allianz), AFS Licence No. 234708, ABN 15 000 122 580. In arranging this insurance, Volkswagen Financial Services Australia Limited, ABN 20 097 071 460 & Volkswagen Group Australia Pty Ltd, ABN 14 093 117 896 and the authorised dealers act as agents of Allianz and not as your agent. Volkswagen Finance is a trading name of Volkswagen Financial Services Australia Limited. Locked Bag 6252, Regents Park, NSW 2143. Tel: 02 9695 6311.

# The Transporter Range

February 2014

Publication: VGATRA003D

[www.volkswagen-commercial.com.au](http://www.volkswagen-commercial.com.au)

Your Volkswagen Dealer

